



This is a digital copy of a book that was preserved for generations on library shelves before it was carefully scanned by Google as part of a project to make the world's books discoverable online.

It has survived long enough for the copyright to expire and the book to enter the public domain. A public domain book is one that was never subject to copyright or whose legal copyright term has expired. Whether a book is in the public domain may vary country to country. Public domain books are our gateways to the past, representing a wealth of history, culture and knowledge that's often difficult to discover.

Marks, notations and other marginalia present in the original volume will appear in this file - a reminder of this book's long journey from the publisher to a library and finally to you.

### **Usage guidelines**

Google is proud to partner with libraries to digitize public domain materials and make them widely accessible. Public domain books belong to the public and we are merely their custodians. Nevertheless, this work is expensive, so in order to keep providing this resource, we have taken steps to prevent abuse by commercial parties, including placing technical restrictions on automated querying.

We also ask that you:

- + *Make non-commercial use of the files* We designed Google Book Search for use by individuals, and we request that you use these files for personal, non-commercial purposes.
- + *Refrain from automated querying* Do not send automated queries of any sort to Google's system: If you are conducting research on machine translation, optical character recognition or other areas where access to a large amount of text is helpful, please contact us. We encourage the use of public domain materials for these purposes and may be able to help.
- + *Maintain attribution* The Google "watermark" you see on each file is essential for informing people about this project and helping them find additional materials through Google Book Search. Please do not remove it.
- + *Keep it legal* Whatever your use, remember that you are responsible for ensuring that what you are doing is legal. Do not assume that just because we believe a book is in the public domain for users in the United States, that the work is also in the public domain for users in other countries. Whether a book is still in copyright varies from country to country, and we can't offer guidance on whether any specific use of any specific book is allowed. Please do not assume that a book's appearance in Google Book Search means it can be used in any manner anywhere in the world. Copyright infringement liability can be quite severe.

### **About Google Book Search**

Google's mission is to organize the world's information and to make it universally accessible and useful. Google Book Search helps readers discover the world's books while helping authors and publishers reach new audiences. You can search through the full text of this book on the web at <http://books.google.com/>

3137  
M18

**HARVARD UNIVERSITY**



**LIBRARY**

**OF THE**

**FOGG ART MUSEUM**

any  
way  
2016

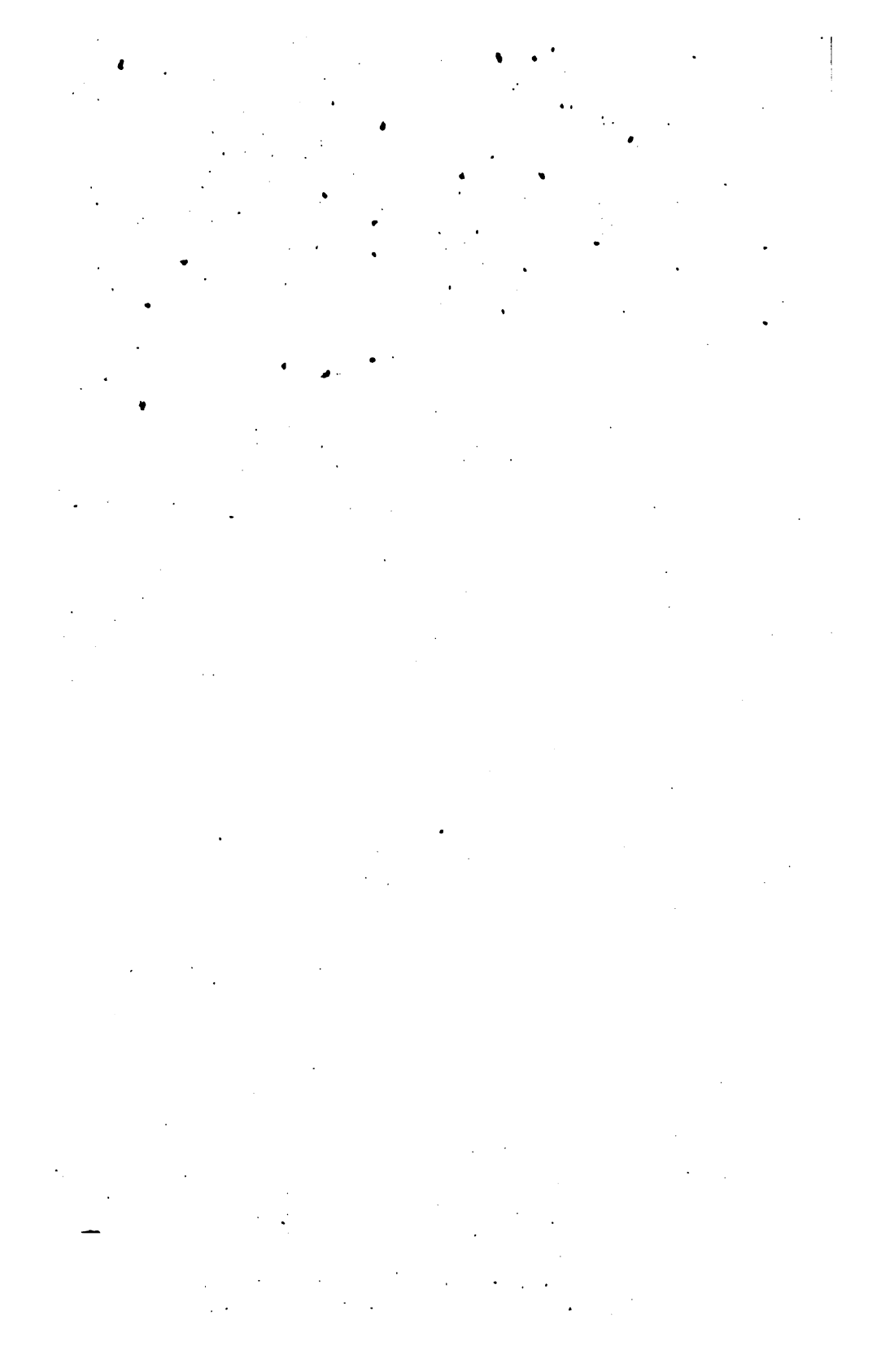

THE MANUFACTURE OF VARNISHES  
AND  
KINDRED INDUSTRIES

VOLUME II.  
VARNISH MATERIALS  
AND  
OIL, VARNISH MAKING

# STANDARD WORKS FOR THE Paint, Colour and Allied Industries.

---

## Three Hundred Shades and How to Mix Them.

By A. DESAINT.

---

Price 21/- net (Post free, 21/6 home ; 22/6 abroad).

---

"An ingenious and new idea in the shape of what may be called a practical colour manual."—*The Builder*, December 28, 1907.

"This is one of the most remarkable books we have ever been called upon to review."—*The Ironmonger*, December 7, 1907.

"It is a most unique work, but one the usefulness of which is likely to commend itself to the practical man at the first glance."—*The Master Builder*, January 1, 1908.

---

## The Manufacture and Comparative Merits of White Lead and Zinc White Paints.

From the French of G. PETIT.

---

Price 4/- net (Post free, 4/3 home ; 4/4 abroad).

---

"In this excellent book the author has succeeded in compressing into a very few pages a vast amount of valuable information. . . . We have pleasure in recommending this book to all interested in paints."—*The Chemical Trade Journal*, Jan. 18, 1908.

"A book of the utmost value to painters and decorators. . . . He (the painter) gets for the nominal price of 4/3 (post free) one of the best (if not the best) books on white lead and zinc white we ever remember reading."—*The Decorators' and Painters' Magazine*, Jan. 15, 1908.

---

## INDUSTRIAL ALCOHOL.

*A Practical Manual on the Production and Use of Alcohol for Industrial Purposes and for Use as a Heating Agent, as an Illuminant and as a Source of Motive Power.*

By JOHN GEDDES McINTOSH.

Demy 8vo. 250 Pages. With 75 Illustrations in the Text, many full page, including Several Plans and 25 Tables.

---

Price 7/6 net (Post free, 7/9 home ; 8/- abroad).

---

Published by

SCOTT, GREENWOOD & SON,

8 Broadway, London, E.C.

THE MANUFACTURE OF  
**VARNISHES**  
AND  
KINDRED INDUSTRIES

BASED ON AND INCLUDING THE "DRYING OILS AND VARNISHES"  
OF

ACH. LIVACHE

BY

JOHN GEDDES McINTOSH

LATE LECTURER ON VARNISH MANUFACTURE AT THE POLYTECHNIC, REGENT STREET, AND  
THE BOROUGH POLYTECHNIC

*SECOND, GREATLY ENLARGED, ENGLISH EDITION,  
IN THREE VOLUMES*

VOLUME II.

VARNISH MATERIALS AND OIL VARNISH MAKING

LONDON

SCOTT, GREENWOOD & SON

"THE OIL AND COLOUR TRADES JOURNAL" OFFICES

8 BROADWAY, LUDGATE HILL, E.C.

1908

*[All rights (including the sole right of translation into English of M. Livache's  
treatise) remain with Scott, Greenwood & Son]*

D. VAN NOSTRAND COMPANY,

NEW YORK

WILLIAM FOGG  
ART M  
HARV... TY

acc. no. 1486

Gift of Mr. E. W. Forbes  
Jan. 17, 1918

**BIBLIOGRAPHICAL NOTE.**

FIRST FRENCH EDITION ISSUED IN PARIS, 1896.

FIRST ENGLISH EDITION (ONE VOLUME), ENLARGED AND ADAPTED,  
ISSUED IN LONDON, 1899.

SECOND ENGLISH EDITION, FURTHER ENLARGED AND IMPROVED (OF  
WHICH THIS IS VOLUME II.), ISSUED 1904-8.



## PREFACE TO SECOND EDITION, VOL. II.

AN apology is due for the delay in the issue of this and the succeeding volume. I can only plead the pressure of many onerous engagements, the somewhat heavy nature of the task, the difficulty experienced (1) in presenting the subject to the reader in something approaching logical sequence, and (2) the delicate task of selecting matter to be included and rejecting other and possibly equally important details. With reference to the frequent quotations from Wilson Neil, I must remark that in varnish-making, as in cooking, the principles of working remain the same, whether the work be done on a small or large scale. So also the beginner in varnish-making who thoroughly masters Wilson Neil's methods of manufacture given in this book will have little to learn and nothing to unlearn when he comes to use the larger and more improved appliances also fully described in the text. The one great essential is to master thoroughly the main principles of oil varnish making; the details of how these principles are to be carried out in a rational manner may very well be left to individual operators. I am therefore very pleased that the publishers have been able to find room for the great bulk of Wilson Neil's Gold Medal essay, each section being in its appropriate place. To attempt to do better on the small scale than Wilson Neil did would be rash. To alter his principles on the large scale would be wrong. To paraphrase his instructions in silence, as so many have done, would be misleading. The author has therefore let him appeal to the reader in his own words, which have lost little or none of their force through the efflux of time. So sound was Wilson Neil in his grasp of the principles of varnish-making that the author can even now only detect one or two slight flaws in his train of thought and argument, such as his vaguely erroneous ideas as to the composition of umber.

The results of the comparatively recent researches of Tschirsch and his coadjutors in the domain of analytical investigations into the composition of resins, have been given in detail in the case of such resins as come within the scope of this volume. These may appeal more forcibly to the student of resins than to the varnish-maker, but the varnish-maker cannot know too much of his raw materials, and, if he has no time for

such researches, yet he should so educate himself as to be able to follow such researches intelligently and to assess them at their true value ; that is to say, as conscientious results obtained by the examination of certain individual samples of certain resins which may or may not be typical of that class of resins. Whilst not attaching too much importance to Tschirsch's results and figures, they yet afford much information as to the proximate constituents of resins, and his unique method of getting at and separating the essential oil from resins seems a peculiarly interesting one. A tabular summary of his results will be given in Vol. III. The various tests for resins to which he refers are described in Dietrich's *Analysis of Resins* (Scott, Greenwood & Son), an accurate and useful work. It may be desirable to point out that the plant shown in Figs. 11-20 of Vol. I. may all be used in oil varnish making for such additional special purposes as they may be adapted.

Vol. III., dealing mainly with spirit varnishes, will be published as soon as possible. It is in course of preparation, and, as it is desirable to make the work as complete as possible, the author will be glad to receive through the publisher any hints as to the inclusion of matter which possibly might not occur to him.

In conclusion, it is hoped that the pledge given in the first edition, *viz.*, "It is hoped in a future edition to render the volume still more serviceable to the English varnish-maker," has in a great measure been fulfilled, and that when Vol. III. is issued the work will be unique of its kind. The great bulk of this volume consists of additional matter, including Dr. Laurie's interesting and ingenious method of testing varnish, for which the author is indebted to Dr. Laurie's own description in the *Oil and Colour Trades Journal*. Acknowledgments are also due to such foreign authors as Tschirsch, Andés, Coffignier, Corde-moy, etc.

J. G. M.

LONDON, *April*, 1908.

# CONTENTS.

|   | PAGE |
|---|------|
| CHAPTER I.  |      |
| INTRODUCTORY - - - - -  | 1    |
| CHAPTER II.   |      |
| AMBER AND AMBER OIL VARNISHES - - - - -   | 11   |
| CHAPTER III.  |      |
| ASPHALTUM, COAL-TAR PITCH, BONE PITCH, STEARINE PITCH, INDIA-<br>RUBBER, GUTTA-PERCHA, PARAFFIN WAX - - - - -                             | 30   |
| CHAPTER IV.   |      |
| COPAL.  |      |
| DEFINITION, GEOGRAPHICAL ORIGIN AND DISTRIBUTION, BOTANICAL<br>SOURCE, COMPOSITION AND PROPERTIES OF THE DIFFERENT<br>VARIETIES - - - - - | 41   |
| CHAPTER V.  |      |
| RESINS : CLEANING, ASSORTING AND FUSING - - - - -   | 88   |
| CHAPTER VI.   |      |
| OIL VARNISH MAKING : GENERAL INSTRUCTIONS - - - - -   | 118  |
| CHAPTER VII.  |      |
| COPAL OIL VARNISHES ; KAURI COPAL VARNISHES - - - - -   | 141  |
| CHAPTER VIII.   |      |
| ROSIN OIL VARNISHES, BRUNSWICK BLACK, SUPER-BLACK JAPAN - -   | 166  |
| CHAPTER IX.   |      |
| TESTING VARNISH, UTILISATION OF RESIDUES - - - - -  | 177  |
| CHAPTER X.  |      |
| UTILISATION OF VARNISH-MAKERS' WASTE PRODUCTS - - - - -   | 198  |
| INDEX - - - - -   | 203  |



## CHAPTER I.

### INTRODUCTORY.

*Definition and constitution of a varnish—Some varnish trade terms—Utility and functions of various varnishes—Oil varnishes and spirit varnishes—Function of drying oils in varnishes—Resins—Thinners—Differentiation between gums and resins, between resins and gum resins, between resins, oleo resins, and balsams—Origin and physical properties of resins.*

THE term "varnish" is used to designate any homogeneous solution or fluid, whether partly volatile or altogether fixed and persistent, whether naturally of a pale or of a dark colour, or artificially coloured, whether thin or viscous, transparent or translucent, or more or less opaque, which, when spread by means of a brush in a thin layer over the surface of an object (properly prepared to receive it), or applied thereto in any other rational manner, dries (1) by the evaporation of the volatile solvent (spirit varnishes, etc.), or (2) by the combined evaporation of the volatile solvent, and the more or less complete oxidation of the viscous residue of oil and resin to an impervious, dry, persistently adherent, smooth, lustrous, elastic film, unaffected, as an ideal varnish should be, by wear or tear, by air or moisture, by the vicissitudes of climate, or by all those extraneous influences included in the term "weather," against each and all of which it should effectually protect the object to which it is applied. Varnishes in the drying of which heat is applied in a closed compartment (but fitted, of course, with a fume escape), so as to expel the vehicle and then fuse the residual layer so that it resembles sheet glass in its uniformity, smoothness and lustre, are termed "Japans"; the "stoving" operation is "Japanning," and the operative is a "Japanner". Both oil varnishes and spirit varnishes are used in "Japanning," and lend themselves with somewhat equal readiness to the process. Oil varnishes, as may readily be conceived, yield the most elastic and the most durable coating. When varnish is used as a vehicle or medium for the application of a pigment, or mixture of pigments, to an object, a so-called enamel is produced. Such "enamels" dry with a gloss, and save labour by combining painting and varnishing into one operation. They are differentiated into (1) *spirit-varnish* enamels, and (2) *oil-varnish* enamels, according to whether the vehicle or medium be (1) a spirit varnish or (2) an oil

varnish. But porcelain glazes, formed by the liquefaction at a regulated temperature of a mineral flux on pottery, glass, iron, etc., are the true enamels. Japanning, therefore, is the only process in the varnishing trade which approaches enamelling, the fusion of the oil and resin on the object to which it is applied being somewhat analogous to that of real enamelling.

Japanning operations may, in fact, be regarded as identical with the preliminary stage of porcelain enamelling. But in true enamelling a much higher temperature is used, sufficient in fact to volatilise completely the viscous medium used as a vehicle for the vitreous pigment. In porcelain enamelling, the pigment has to be dissolved throughout the silicious matrix on the surface of the porcelain. In japanning the pigment is diffused through a fused resino-oleaginous medium. For many purposes varnishes drying with a dull surface are preferred; such varnishes are termed *matte* varnishes by the photographer, and *flattig* varnishes by the decorative painter. On the other hand, where the especial lustre, and brilliancy, and uniform smoothness of surface, so much better appreciated when seen than when described, are requisite, the result is attained by the application of certain spirit varnishes which are applied by means of a pad, with a peculiar circular turn of the wrist, and by lubricating the pad with a little linseed oil to aid the development of the characteristic lustre, massive smoothness and homogeneity, and uniformity of such varnished surfaces. Varnishes of this class are termed polishes, French polish, for instance, in which shellac should be the chief ingredient. Furniture polish is an ephemeral extemporaneous product, in which beeswax should predominate.

The proper German term for varnish is their *lac*, not their *firniss*, which is boiled oil, but this *lac* again must not be confounded with "gum lac," "shellac," stick lac on the one hand, nor with Burmese, Chinese or Japanese natural "lacs" or natural varnishes on the other hand, nor indeed must it be confused with what we call *lacquer*, a thin spirituous solution of resin appropriately coloured and applied to metals, leather, etc., as a protective coating or layer, and much used on the brass work of scientific instruments, bedsteads, etc.

*Utility of Varnishing.*—From a mere utilitarian point of view, articles, whether consisting of wood, metal, glass, stone, leather, paper, etc., are varnished because the impervious film or coating preserves them from wear and tear, the oxidising action of air and moisture, and all those extraneous disintegrating and corrosive influences included under the term "weather," noxious gases, etc., acid fumes, and, in special cases, even from the strong acids themselves; at the same time the uniform smoothness, transparency and brilliancy of the film are pleasant to the eye and the touch. Owing to the presence of antiseptic and toxic substances in the resins, oils, etc., which enter into the composition of certain varnishes, these, in addition to preserving the objects to which they are applied from ordinary wear and tear, also protect them from the ravages of insects,

*e.g.*, wooden structures from white ants in tropical climates. Even in Britain the parasites which infest the timber of town dwellings usually avoid varnished wood. The varnishing of floors, etc., is therefore a better remedy than periodical scrubbing with carbolic soap. "Dry rot" may also be prevented in a similar way; or varnishes containing toxic principles, whether present naturally in the resins or solvent, or purposely added thereto, may prevent undesirable lower forms of animal life from attaching themselves to the object to which they have been applied, such as antifouling compositions, some of which, however, partake more of the nature of a paint than a varnish. The attachment of barnacles to the hulls of ships greatly reduces the speed of the vessel. Compositions in which the vehicle of pigment and molluscicide partakes of the nature of a varnish are the most effectual preventatives.

When a coat of varnish has been given to any article it should dry rapidly to a uniform, durable film, possessing the properties just enumerated, neither crumbling nor cracking, but persistently adhering to the object to which it has been applied, and elastic enough to yield or stretch, with any bending action to which the article may be exposed, in its daily use.

The varnish must not melt and run under the heat of the warmest summer day, neither must it be so brittle as to crack when the surface to which it is applied, such as a strip of leather, or tinsplate, is bent. It must be supple and elastic; neither brittle nor readily fusible. Tests made on varnishes only recently applied are valueless. The bending of a piece of tin, leather, canvas or paper without cracking the varnish means nothing unless it be known how long it is since the varnish tested in this way has been applied. Besides, the condition of the weather at the time of the experiment must be taken into account. A coat of paraffin wax on a mild day is quite elastic, on a cold day it is as brittle as glass, while on a hot day it runs in greasy streams.

In addition to a preservative action, varnishes have a decorative effect. The application of a coat of varnish to any porous surface, dressed and smoothed in an appropriate manner, enhances its appearance by imparting thereto a uniform polished glassy lustre. Should the object to which it is applied consist of previously dressed wood, it not only brings into bolder relief the more prominent structural features of the wood, by filling up the pores thereof with a transparent medium, but by a light and shade contrast (produced by the harder and denser fibres as against the softer and less compact) it brings prominently into view all the characteristic modifications and ramifications of the woody fibre of different timbers included under the term "grain". The whole structure of the wood is, as it were, brought to the same level by actual contact with a glassy surface. By colouring the varnish, artificially, by colouring principles, soluble in the varnish, like that of alkanet root, a stained glassy surface is produced, by which poorer quality timber may be made to pass for better

quality; the same result may also be arrived at by using aniline dyes, coloured resins, gamboge, dragon's-blood, grass-tree gum, etc. The colouring principle, by being fixed more intensively on certain portions of the grain of the wood than upon others, still further brings the grain into more bold relief and still further accentuates the beautifying effect of the varnish.

*Constituents of Varnish.*—The principal substances which enter into the composition of a coating fulfilling the above requirements are resins and drying oils. The latter have been dealt with in vol. i. of this treatise.

*Resins* are sometimes applied to the object to be varnished, in the simple state of solution, in a volatile liquid, such as shellac, in methylated spirit, dammar, or in spirits of turpentine (or in naphtha). Such varnishes are all loosely termed *spirit varnishes*, but the term "spirit varnish" is more strictly confined to solutions of shellac and certain other resins (*e.g.*, sandarac) in alcohol, or rather in those denatured varieties of alcohol permitted to be sold free of duty, but under certain restrictions, by the Excise, *viz.*, "methylated spirit," "Finish". Again, those "spirit varnishes," the only liquid spirituous constituent of which is spirits of turpentine, are known as turpentine varnishes. In the same way aqueous solutions of resins, in an alkaline ley, whether in dilute solutions of caustic or of carbonated alkali, or of borax, are known, but erroneously so, as water varnishes. A pure water varnish, into which unchanged resin enters, is an impossibility, as unchanged resin is insoluble in water. There are, indeed, true water varnishes, but such varnishes are solutions of gums, either of gum-arabic or of analogous gums, or of sugars, or of substances allied thereto. And this, naturally, brings us to the definition of a gum and its differentiation from a resin. We will not, however, stop here to define a gum further than to say that it belongs to the class of carbohydrates, that it consists of carbon, hydrogen and oxygen, and that though the hydrogen and oxygen do not exist in gum as water, yet they are present in the same proportion as in water. A gum is a much more highly oxidised product than a resin. A typical formula for a gum is  $(C_6H_{10}O_6)^n$ , for a resin  $C_{10}H_{16}O$ , which give the following percentage compositions:—

|                    | Gum.   | Resin. |
|--------------------|--------|--------|
| Carbon . . . . .   | 44.45  | 78.94  |
| Hydrogen . . . . . | 6.17   | 10.53  |
| Oxygen . . . . .   | 49.38  | 10.53  |
|                    | <hr/>  | <hr/>  |
|                    | 100.00 | 100.00 |

A true natural gum is completely soluble in pure water without the aid of acid, alkali or salt, and is reprecipitated therefrom by alcohol, in which it is insoluble. A true resin is insoluble in water but is often soluble in alcohol, from which it is reprecipitated by water, in which it is insoluble unless aided by alkalies, etc. But alkaline solutions change resins into resin soaps. Water varnishes of the latter class are therefore aqueous solutions of resin soaps. Typical spirit



varnishes are solutions of resins in alcohol. This class of varnish yields, however, on drying a brittle coat, consisting practically of the unchanged original resin, presenting all its merits and defects. Spirit varnishes are therefore liable to crack, and but little calculated to stand wear and tear and the action of the weather. They cannot be used for outdoor decoration. To give the resulting coat more elasticity, as in the manufacture of oil varnishes, resins are dissolved by the aid of heat in a drying oil, almost invariably linseed oil. (*Resina omnis dissolvitur oleo*, Pliny, xiv., 20.) The product, *i.e.*, the solution of the resin, in the linseed oil is thinned down with a volatile solvent, in which both oil and resin mutually and reciprocally dissolve, such as spirits of turpentine. Drying oils thus play a double part in the manufacture of oil varnishes. They not only act as solvents but impart elasticity and durability to the varnish (see vol. i., pp. 1-4).

The particles of resin in the dried varnish, instead of holding together by mutual brittle cohesion, are bound or cemented together by a pliant, elastic and supple binding agent, *viz.*, oxidised linseed oil. Oil varnishes have consequently a much more varied and extended use not only for outdoor but also for indoor decoration. They are eventually (though less easily and quickly applied and finished off) in every way far more serviceable and durable than spirit varnishes. Moreover, a fresh coating of good oil varnish does not disturb, remove, dissolve, or in any way interfere with the previous coating of oil varnish. The previous coating of dried oil varnish is insoluble in the new one. As the quality of a varnish depends, in great measure, on the materials from which it has been manufactured, it is necessary at the outset to study the properties of these raw materials, first of all, so as to be able in buying such for varnish manufacture to discriminate between the genuine article and either one or other of the substitutes continually being palmed off as just as good as the real article, or sophisticated products, vended as the genuine product, and secondly, so as to become acquainted with their greater or less adaptability to serve the special purpose for which the varnish is intended. For instance, to take an extreme case, one would not purchase raw materials of low melting-point for incorporation into a varnish intended to stand heat. The varnish-maker must therefore know the special manner, if any, in which any given raw material behaves after being made into varnish; and he must not only know how the raw material comports itself, by itself alone, but also how it influences and is influenced by the presence of the other raw materials with which it is associated in the varnish, whether these be solid or liquid, the solvent or the substance dissolved. Some varieties of "copal," *e.g.*, Manilla, have the bad habit of stringing when made into varnish; the addition of rosin diminishes this tendency. Some pitches, such as bone pitch, are very insoluble and intractable and tricky. The addition of rosin increases the solubility of the pitch and diminishes the tricky tendency thereof to fall out of solution on the slightest or even on no visible provocation.

Similar instances might be multiplied, but these must suffice here. The first principle to be inculcated in the training of a varnish-maker therefore is to impress upon him the desirability of knowing his raw materials in all their different phases thoroughly and well. Besides volatile oils and other solvents, drying oils and resins, several subsidiary products are used in varnish-making, such as driers, linoleates, resinates and colouring principles. Again, in certain varnishes various hydrocarbides are introduced, such as asphaltum, coal-tar pitch, bone pitch, stearine pitch, petroleum pitch, blast furnace pitch; inspissated juices, such as india-rubber, gutta-percha, balata. Collodion and celluloid are also used in varnish-making, and the varnishes so made employed in conjunction with copal varnish furnish us with the material known under so many phases as pegamoid, *i.e.*, artificial leather.

The solids, *i.e.*, the resins, gum-resins, balsams, etc., employed (a) in oil varnish-making are: (1) amber; (2) copal (including Kauri and Manilla); (3) rosin; (4) asphaltum, including the various pitches, *viz.*, coal-tar pitch, stearine pitch, bone pitch. The solids employed (b) in alcohol spirit varnish-making are shellac, sandarac, benzoin, spirit Manilla, accroides, Burgundy pitch or gum thus, elemi, rosin with various oleo-resins, *e.g.*, Venice turpentine, Canada balsam and copaiba balsam. The chief resinous colouring principles used in spirit varnish-making are dragon's-blood and gamboge. Alkanet root may be used to colour oil varnishes. As resins play a part of supreme importance in varnish-making, it behoves us to study them with care, and if the particular exigencies of the varnish-maker make it imperative that the trend of this study should bear more essentially upon such properties as hardness, fusibility, solubility in different solvents, and the behaviour of the resin during fusion, solution and after solution, in fact both during the application and drying of the varnish, and so on, yet there are several other points, both of scientific, technical and commercial importance, which crop up in the examination of resins, which the varnish-maker of the present day cannot, in the present advanced state both of science and technology, afford to overlook if he really means to keep abreast of the times, and maintain an intelligent interest in the progress that is being made continually from day to day in the preparation of the raw materials used and the final products elaborated in his trade. The sooner he realises that if he does not do so he will, as a case of the survival of the fittest, eventually go to the wall, the better for the British varnish-maker.

*Formation of Resins and Oleo-resins from the Oxidation of the Essential Oils elaborated in Plants.*—First of all, it will be necessary to define a resin a little more fully, and here, at the very outset, we encounter a difficulty. It is indeed almost impossible to give a good general definition applicable, in the aggregate, to the assemblage of bodies classified as resins. It is found in actual practice to be more rational to divide them into groups, which may then be more

exactly, if still somewhat imperfectly, defined. Much light is thrown on the subject by a careful examination of the manner in which resins are elaborated by the plant. Resins are, in fact, the oxidation or the hydration products of the essential oils. The essential oils, consisting of hydrocarbides, first appear in the protoplasm of the cells of the cellular tissue as minute, highly refractive, oily drops. Sometimes they may remain in the cells in which they have been elaborated, these cells being isolated, or aggregated into distinct masses. At other times these special cells are arranged round an interior highly elongated cavity, the essential oil after the gelatinisation of the internal membranes or cell-wall flows into and accumulates in this central reservoir, which is termed a secreting vessel (Fig. 9, *cs*). On oxidation essential oils are transformed into more stable compounds, *viz.*, resins. But if the essential oil be only partially oxidised, the resulting compound of oxygen and essential oil still remains a liquid, and is termed an oleo-resin. If oxidation be complete, if the whole of the essential oil has been acted upon, the resulting mass solidifies, and we get a pure, that is, a true resin. The Dipterocarpus family of plants affords us excellent examples of these two sorts of resinous bodies. The genus *Dipterocarpus* yields a fluid oleo-resin known in commerce as "Gurjun balsam," and also as Cochin China wood oil, not to be confounded with Japanese or Chinese wood oil. This so-called "wood oil" is an oleo-resin. It contains both resin and unchanged essential oil. On the other hand, other genera of *Dipterocarpus* trees, such as *Vateria*, *Shorea*, *Hopea* and *Vatica*, yield true, pure resin abundantly. However, this distinction between resins and oleo-resins is more relative than absolute, as certain hard resinous bodies, formerly regarded as consisting wholly and solely of resin pure and simple, have been found to yield on distillation a larger or smaller quantity of essential oil. Dammar, for instance, yields, on distillation, 3.13 per cent. of essential oil.

*Balsams.*—Under the term "balsams" are designated those liquid or solid resins which contain benzoic or cinnamic acids, or both these acids simultaneously. When the benzoic acid and essential oil, if any, is eliminated from the balsam, the residue consists of resin. The above are the three types to which all resins may be referred: (1) resin pure and simple; (2) oleo-resin; (3) balsam. However, a great many of these resinous substances are too little known to allow them to be definitely classified. Certain balsams, or at least certain substances, designated as such are possibly nothing more than oleo-resins and *vice versâ*. Moreover, between the resins and the oleo-resins there are a host of intermediate products the properties of which are undecided. Hence in the actual state of our knowledge a rigorous classification based on chemical constitution seems impossible. It is therefore wise, unless we wish to court inevitable error, to rest content with successively examining resinous substances in the order of their relative importance, without attempting to classify them according to the as yet insufficient and uncertain chemical data



those from which resins are formed in nature; it is an unsaturated body as its empirical graphic formula shows. The six free monad bonds can thus absorb as many as 3 atoms of dyad oxygen. Nature when it converts essential oils into resins never completes the operation but leaves the resin in all the different stages and phases of transition. Hence the cause of the difference in properties in different lots, nay, in different lumps of the same lot of the same resin. But the more easy solution and fusion of resins by exposure to air, unless finely ground so as to expose essential oil and aid its conversion into a camphor-like body, is possibly due to dehydration—mere expulsion of interstitial or loosely combined water by a process akin, say, to efflorescence than to the action of the air which should otherwise be the converse of that attributed to it.

TABLE I.—SCALE OF HARDNESS OF VARNISH RESINS.

| <i>Oil Varnish Resins.</i>                     |                           |                      |
|--|---------------------------|----------------------|
| (A.) AMBER.                                    |                           |                      |
| (B.) COPAL:—                                   | Hard.                     | Soft.                |
| Medium.  |                           |                      |
| 1. Zanzibar.                                   | 4. Sierra Leone.          | 17. Manilla.         |
| 2. Mozambique.                                 | 5. Angola Red.            | 18. Borneo.          |
| 3. Madagascar.                                 | 6. Benguela.              | 19. Singapore.       |
|  | 7. Bastard Angola.        | 20. South American.  |
|  | 8. Copal Pebble.          | 21. Brazil (Guiana). |
|  | 9. Akra.                  | 22. Cochin China.    |
|  | 10. Benin.                |                      |
|  | 11. Loango.               |                      |
|  | 12. Gaboon.               |                      |
|  | 13. Congo.                |                      |
|  | 14. Sierra Leone.         |                      |
|  | 15. Angola White.         |                      |
|  | 16. Kauri.                |                      |
| <i>Others (chiefly Spirit) Varnish Resins.</i> |                           |                      |
|  | 1. Dammar.                |                      |
|  | 2. Shellac.               |                      |
|  | 3. Mastic.                |                      |
|  | 4. Sandarac.              |                      |
|  | 5. Rosin.                 |                      |
|  | 6. Elemi.                 |                      |
|  | 7. Oleo-resin Turpentine. |                      |
|  | 8. Burgundy Pitch.        |                      |
|  | 9. Asphaltum.             |                      |

*Influence of Hardness of Resins on Durability of Varnish.*—Coming now to the properties of individual resins from a varnish-maker's point of view, he has to bear in mind that resins not only impart whatever brilliancy they possess to varnish, but the hardness of the varnish depends, other things being equal, wholly and solely on the resin. Knowing therefore the hardness of any resin, we can, to a certain extent, determine beforehand the quality of varnish it will produce. In commerce, resins and gum-resins are divided into classes according to their hardness, *viz.*, hard, semi-hard, medium and soft. The hard and semi-hard resins are furnished by plants be-

longing to the *Hymenœa* (a family of plants appertaining to the sub-order of *Cœsalpineæ*), the principal of which are the hard copals, or gum animés of Zanzibar, Mozambique and Madagascar and the semi-hard copals of Sierra Leone, Benguela and Angola. The medium hard resins are produced by coniferous trees ; such are Manilla and Kauri "copals". Finally, soft resins, amongst which are benzoin, sandarac, dragon's-blood and gamboge, are produced by the family of *Juglandaceæ*, etc.

*Influence of Hardness on Solubility of Resins.*—There is a certain correlation between the hardness and the solubility of the resin. The softer the resin, the more tractable it is, the more easily does it fuse and dissolve, and *vice versâ* the harder the resin the more insoluble it is. The solubility of a resin may be said to be in inverse proportion to its hardness. The hard resins and semi-hard resins are but very slightly soluble in their original condition working in the cold, but they are easily dissolved by spirits of turpentine, linseed oil and other solvents, by previously heating them in such a manner as to cause them to lose, by destructive fractional distillation, 10 to 25 per cent. or more of their weight of a resinous oil (copal oil, amber oil), according to the resin dealt with in this manner. The partial destructive distillation of the harder resins is necessary before they dissolve in oil or other solvents. A great deal more oil must be distilled from hard resins before they become soluble than from soft resins. Besides solubility, we have to note in the case of each resin : (1) its geographical and botanical origin ; (2) its composition ; (3) the adulterations to which each resin is subject ; (4) the means whereby such adulteration may be detected ; (5) the conditions to be observed in the manufacture of good varnish from any given resin ; (6) the distinctive features by which it can be recognised at sight.

## CHAPTER II.

### AMBER AND AMBER-OIL VARNISHES.

*Early history—Geographical and geological distribution of amber and its varieties—Palaeontological or mineralogical classification—Electrical and optical properties—Chemical composition (proximate and ultimate)—Sophistication—Use and application in varnish-making, in silk industry, and in amber-oil varnishes.*

1. *Amber*.—Density, 1·08; hardness, 2·25 on Moh's scale; melting-point, 287-290° C. (549-554° F.). History: Amber (synonyms: Latin *Succinum*, French *Succin*, Greek *Electron*, German *Bernstein*—*succinit*, *gedanit*, *glessit*, *Stantienit*, *Beckerit*, *Simetit*, *Rumanit*, *Krantzit*) was known many centuries before Christ. Electricity is derived from *electron*, the ancient Greek name for amber. Theophrastes, B.C. 300, refers to its properties of electrical attraction. It is also referred to in different connections by Homer, Dioscorides, Virgil, Tacitus, Pliny, etc. The Latin term for amber, *succinum*, is derived from the Latin *succum*, juice. "*Arboris succum esse prisca nostri credidere ob id succinum appellantes*" (Pliny, xxxvii. 3). "*Sed et mare scrutantur ac soli omnium succinum quod ipsi glassum vocant, inter vada in ipso littore legunt*" (Tacitus, *De moribus Germ.*). See also Virgil, 8th *Æneid*. Coming down to more recent times, Dr. Watson, Bishop of Landaff, writing (when Professor of Divinity in Cambridge University) in 1782 in his chemical essays, says: "The natural history of amber is very obscure. This bitumen (*sic*) was for a long time thought to be restricted to the coasts of Prussia on the Baltic Sea. It was supposed to owe its origin to the exudations of certain trees on the coasts of Sweden which falling into the sea were there hardened by the continual action of the salts and thence carried by particular winds to the open coasts of Prussia. This opinion was supported by and formed to account for the ants, flies, spiders, leaves of trees and other terrestrial matters which are almost always found enclosed in pieces of amber, and which no doubt must be admitted as proving its being originally in a fluid state. In Prussia they not only gather amber on the sea-coast, but frequently find it at the depth of eight or ten feet beneath the surface of the earth though at no great distance from the sea. The superincumbent strata are sand, clay, fossil wood, pyrites, and sand again in which the amber is found sometimes in detached pieces, sometimes in little heaps. This distribution of the strata where amber is found together with their proximity to the sea

has made it with some degree of probability be imagined that this mineral owes its situation to the inundation and recession of the sea, and that it was derived partly from an oil arising from the decomposition of vegetables by subterranean fire and partly from a mineral acid. Amber is frequently found in Italy where they have no fossil wood but great plenty of petroleum." Dr. Watson's description of its occurrence, etc., is in the main valid to the present day.

Although amber is classed by mineralogists as a mineral, and generally but erroneously included by them in the class of bitumens, it is in reality a widely distributed, but except in one or two localities, a far from abundant fossil resin—the product principally of prehistoric conifers, *Pinus succinifer*, amongst others, which flourished many thousand years ago upon the Greensand beds of the Cretaceous formation. The vast forest in which these pines grew is supposed to have stretched from Norfolk, England, and from Holland through Germany, Finland, Siberia and Kamschatka to North America.

*Occurrence and Localities.*—Amber is met with in thin plates and nodules, disseminated in the sands, clays and lignites of the Greensand formation (Lower Tertiary, Unter-oligocen) along the German shores of the Baltic. It is sometimes found in thin plates between the layer of lignites, but nearer the bark than in the centre of the trunk, like the occurrence of the resin of certain resiniferous conifers of the present day. Goepfert was the first to discover that amber was the product of a species of pine, *Pinites succinifer* (Goepf. and Berndt), *Pinus succinifera* (Conw.). Conwentz describes three other species of amber-bearing pines: *P. sylvaticus*, *P. Baltica* and *P. cembriifolia*, from one of which alone *succinit*, or true amber, is produced, viz., from *P. succinifera*. The other varieties of amber-producing trees yield *gedanit*, etc. Conwentz has studied the formation of resin in succiniferous trees. Their resiniferous vessels do not differ essentially from those of certain resiniferous pines of the present day, viz., the *abietinae*. What characterised the amber trees was the fact that the resin did not flow from wounds alone, but from resiniferous reservoirs communicating with one another, a process of elaboration termed *succinosis* by Conwentz in his study of the amber-bearing pines, and *resinosis* by the chemico-physiological resin experts of the present day in their study of resin secretion by present-day plants. But in a text-book on varnish-making it would be out of place to pursue this subject further.

The district known as Samland, in Eastern Germany, is the chief amber-mining centre. It is from this district that the markets of the world are supplied. Beyond Germany the yield of amber is comparatively trifling, and the working unprofitable. On the shores of Britain, especially on the Essex, Sussex, Norfolk and Suffolk coasts, after severe storms, such as the autumnal equinoctial gales, as well as on the coasts of Denmark and Scandinavia, it is often thrown up on the beach. But in these cases there is every reason to believe it has been washed away and drifted from the Baltic beds.



This is the more credible when we remember that the specific gravity of amber is 1.08, and that of sea water 1.027, and that the force of the waves will, at such a time of wind and weather, possibly overcome the small difference in gravity and cause the amber to drift with the current.

A sort of hybrid between amber and copal—copaline or Highgate resin—is mentioned as found in the London Clay at Highgate Hill and Kensington (London), but not in sufficient quantity to be of any use; moreover, it is as friable as common rosin, and its connection with amber is very problematical. Amber occurs in the Paris Basin, associated with the bituminous deposits of the Paris Clay, and in the departments of Aisne, Loire, Gard and Bas-Rhin, and near Bâle, in Switzerland. On the Sicilian coast greenish or bluish-violet specimens are found. It is also found on the Italian shores of the Adriatic. Near Prague, the capital of Bohemia, in sinking a well an extensive deposit of amber was found, some of the pieces weighing 2 to 3 lb. Beds of brown amber occur in Roumania, in the mountains of Sibicio, Valley of Burgo, which, it is said, with capital, skill and energy, might be worked profitably.

In North America amber is found at Gay Head, near Trenton, and Vincent Town, Camden, New Jersey, the specific gravity of that found in the latter district being said to be less than that of water; it also occurs at Cape Sable, Maryland. All the United States specimens are found in the Red Clay, subjacent to the Greensand, or in the Greensand itself.

#### *Mining and Dredging.*

(1) *Mining Amber.*—Amber is mined in a greyish black, peaty earth, in the Hakong Valley, S.W. of the Mien Khorm Plains in British Burmah, at an altitude of 1,050 feet. It is mined by sinking pits to a maximum depth of 40 feet. But the most extensive and productive amber-bearing deposits in the world are found in the district of Samland, Eastern Prussia. The amber is there mined systematically, and the working of the mines is a monopoly of the German Government. It is found at a depth of 108 feet below the surface and 46 feet below sea-level, in the blue earth, a friable bluish free-stone constituting the lowest stratum of the Cretaceous or Chalk formation in that region. It varies in thickness from 10 to 30 feet, but only the lowest 6 to 12 feet, are worked, and, as the working is below sea-level, great care has to be exercised to prevent the shafts and tunnels being swamped by an inflow of sea water and sand. The earth sent up to the surface for examination was formerly washed through a wide-meshed screen or sieve into a long inclined trough, at distances of 6 feet apart; the valuable pieces of amber were collected by means of nets. The rubbish or tailings are run into the sea, through a sieve with meshes of about one-third of an inch. Latterly, however, the troughs and nets have been replaced by sifting machines or jiggers. These jiggers are fitted with sieves with a mesh of one-

eight of an inch, and from 15 to 20 tons of earth per hour can be passed through them.

The amount of earth dealt with monthly in these mines is about 7,500 to 12,500 tons, giving 3 to 6 tons of "large" and a ton to three-quarters of "small," the cost of production varying from 4s. 6d. to 7s. a lb.; 20 cubic feet of earth yields about 2½ lb. of amber of a mean value at the mines of 1s. 3d. for small and 7s. 6d. for large. The exact extent and geological distribution of these amber deposits of Eastern Prussia have not been definitely ascertained, as during hurricanes very appreciable quantities of resin are found amongst the débris washed from the sand hills of a lower geological stratum than the mines along the coast.

This latter variety is known as *fliesen* amber (*succin maritime*), that from the mines being termed *erd* amber (*succin terrestre*). *Fliesen* amber is softer than *erd* amber, has a smooth, lustrous, rounded surface, whilst that from the mines, *erd* amber, is angular, rugose, and covered by a rather hard crust.

(2) *Dredging and Levigating Marine Amber*.—Marine amber is got by steam dredging at Schwarzort on the Kurischer Haff, close to Memel. The yield by dredging is close upon 100,000 lb. annually, and this large yield has very materially reduced the price. It occurs in nodules, associated with lignite in the sand at a depth of about 10 feet. The sand, as it is dredged, is sent ashore and levigated in the same way as that from the mines. In all, Eastern Prussia exports about 150 tons of amber annually. In Western Germany amber occurs under circumstances similar to those of Eastern Germany, *viz.*, in the sea and mines, but on land the mines are not at all profitable. Insects and spiders of different genera living at the present day, but all of extinct species, are often found embedded or entombed in amber, having found a living grave in the original oleo-resin as it flowed from this almost primeval pine. Some genera of the various insects found in amber still live in America and Australia, but the species may be said to be extinct. A single specimen of an insect still found in America has been observed in amber, *viz.*, *Lepisma Saccharinum*.

*Varieties*.—According to Leppert the following are the different kinds of amber in the market: (1) *The coloured Amber of Kunst*, pale yellow and shining, or greenish and dull. (2) *Bastert Amber*, a deeper, opaque yellow, citron to dark yellow. (3) *Bone-coloured Amber*, dull, milk-white, opaque yellow in parts, rich in succinic acid. (4) *Agate-coloured Amber*. (5) *Schlaubig Amber*, greenish yellow, transparent, but containing organic débris. (6) *Transparent Amber*, from pale yellow to deep yellow or even red (*cf.* Tables, pp. 19, 20).

*General Properties*. (a) *Colour*.—Amber is, therefore, of various tints and degrees of opacity, transparency and translucency, the same specimen often showing marked variations in this respect. The colours vary from pale yellow to orange, hyacinth red, brown, violet, green, water-white, milky and chalky, and even black. The weathered crust is dark and firmly adherent. *Blue* is due to the presence of vivianite, ferric phosphate,  $Fe_3P_2O_8$ . The *milk-white*,

opaque, *bone-like* specimens owe their appearance to the presence of an excess of succinic acid in the free state (p. 21). Sunlight darkens the lighter-tinted varieties. Cloudiness, caused by enclosed water, may be removed by boiling in linseed oil. The fresh *fracture* of amber, which is conchoidal (shell-like), is more or less fluorescent, shining and vitreous. Its consistency is solid, hard, brittle. It has no smell, and its taste (if any) is insipid. However, when amber is strongly rubbed it gives off a peculiar odour, and acquires electrical properties, becoming strongly negatively electrified by friction on a woollen cloth.

(b) *Hardness and Density*.—Amber is the hardest known resin, 2 to 2·5 on Moh's scale. After fusion its hardness is slightly less. Its imponderable nature did not escape notice in remote antiquity. "*Hanc levissimam substantiam*" (Cassid., vi. 1). Its density is 1·08 (1·05-1·096, Conwentz); Gedanit, 1·058-1·068; Murber Bernstein, 1·060-1·066.

(c) *Fusibility*.—The melting-point of amber varies from 287 to 290° C. (about 548·6-554° F.). When heated it decomposes and gives off a pleasant aromatic smell, fuses and burns with a bright flame. When gradually heated in linseed oil to the "boiling" point of the latter, and kept at that temperature for twenty hours, it becomes soft, pliable and ductile, but does not melt nor decompose. It must, however, be cooled slowly in the oil, or it becomes as brittle as glass. Opaque spots may in this manner be rendered translucent, and the amber moulded to any form, and pieces can even be cemented together. Amber is repaired by smearing the fracture with linseed oil, pressing the pieces energetically together and heating them by holding them over a charcoal fire.

Amber may be dyed by inserting it in linseed oil coloured by alkanet root, dragon's-blood, alizarine, purpurine or coal-tar dyes. The heat is maintained at 190-200 °C (374-392° F.) for a few minutes and then allowing it to cool slowly in the oil. Heated in a fluorescent oil, amber also becomes fluorescent.

*Adulterations*.—Amber is sophisticated with soft copals, common resins, rosin and with amber-coloured fluorides. It is imitated by coloured glass, celluloid and specially treated rosin.

The first test to apply is that of smell. All other resins, even copal, give off a characteristic odour when rubbed between the fingers. The second test is the behaviour of the sample when heated. Soft copals melt between 180 and 200° C. (356-392° F.). A fragment of the substance when held in the candle flame, if pure amber, will melt without running. Should it contain copal it will run down in drops. Real amber gives off sulphuretted hydrogen when strongly heated, and the fumes blacken lead acetate test paper. Copals are quite free from sulphur. Amber is insoluble in cajeput oil, etc., whilst some copals are said to be quite soluble. The addition of copal may also be recognised by the development of the smell characteristic of copaiba balsam on treatment with potash solution. Copal gives no ester value, but amber does. If hard, better quality, copal has been added

to the sample, it may be detected by a test depending upon the difference in hardness between amber and copal. A crystal of rock salt, as pure as possible, is cleaned so as to present a well-polished and brilliant face. The operator then tries to scratch this face with the sharp point of a piece of the sample. If the face of the crystal, on inspection with a lens, shows scratches, the sample is pure amber; whilst hard copal would not produce any impression. Common resins and rosins may be detected by softening in boiling water, or by their solubility in alcohol. To detect rosin or resins, spot a little alcohol on the sample. True amber is unaffected, amber containing rosin or resins becomes dull. Fluorides are easily detected by testing with a metallic point. The bright, distinct interference colours shown under polarised light and crossed Nicol prisms by thin pieces of amber, especially when heated and melted, serve to differentiate it from sophisticated samples.

*Uses.*—The finest kinds of amber are used in the manufacture of articles for personal adornment, and other articles of ornamental turnery, beads, trinkets, etc., as well as for mouthpieces for pipes and cigar-holders, which has given rise to the mineralogical witticism that it is usually associated with meerschaum. Orientals regard amber trinkets with more favour than Europeans, and the Turks and other orientals value it as a charm against infection, a circumstance perhaps due to its borneol camphor content. When intended to be used in the manufacture of ornaments, the amber is split on a leaden plate in a lathe, and then ground to the necessary shape on a Swedish whetstone, and afterwards polished with chalk and water or vegetable oil, and finished by rubbing with a woollen rag. Owing to the friction developed in grinding and polishing, the amber becomes very hot and highly charged with electricity, even to such a degree as to produce electrical currents in the arms of the operator, giving rise to nervous tremors, like those from a galvanic battery. These can easily be avoided by the operator working the pieces one after the other, so as not to allow any one of them to get unduly heated. The German towns engaged in the working of amber and the selling of both crude and finished articles are Dantzig, Königsberg, Stolpen, Breslau and Lubeck. At the present moment (1907) the trade in amber ornaments is brisk, but hampered by labour troubles. The chief markets are Constantinople, London, Paris, Moscow, Vienna and New York. A chloroformic solution of amber (1 lb. of amber, 2 lb. of chloroform) has been used to impart a soft smooth feeling and elasticity to silk goods in the same way as a solution of pyroxylin in amyl acetate is applied to cotton goods.

*Points to be Observed in Manufacture.*—Buy only the best quality. Inferior samples yield dark varnishes—difficult to sell. It is very questionable whether amber is at the present day used in England to any great extent as an ingredient of varnishes. There are, however, violin varnishes on the market, the resinous constituent of which is guaranteed to consist wholly of amber. Formerly, no doubt,

when copals were not so abundant, it played an important part in the manufacture of high class coach varnishes and japans.

Borowski (British Patent 3621 [1877]) makes blocks of amber from small pieces of amber waste, etc. A perfectly tight box constructed from two iron angles, *a*, Fig. 1, adapted to a bottom plate, *b*, is fixed in position in the stand, by means of the screws *A*, and is well covered internally with putty, to exclude air and prevent the escape of volatile matter; the fragmentary amber is then filled in and covered with putty. The box is gradually heated to about 500° C., either by fuel placed around it and in the grooves *B* or by other means, and a well-fitting piston is pressed into the box by the screw *C*, at first lightly, but afterwards more strongly, the pressure being maintained during the subsequent gradual cooling.

As large-sized blocks of amber may be thus prepared from amber waste by pressure, methods have been devised to differentiate between natural lumps and lumps formed by the coalescence under pressure of amber waste into one homogeneous whole. When polished, says Helm, the transparent blocks of coalesced particles of amber show a characteristic property which cannot be detected except by the eye of an expert. When the block is held up to the light so as to view the interior by transmitted light, the internal structure is seen to be far from being perfectly uniform, the whole interior appears to be traversed by numerous hazy, wave-like films, which really form the lines of contact of the numerous lumps, which in the aggregate constitute the block. Under the polariscope amber pressed into blocks behaves in a characteristic manner. Placed between crossed Nicols, polished natural Baltic amber exhibits faint but seldom bright interference bands, but on rotating the plane of the polariscope, through 90°, the colours pass into their complementaries and return to their original hue when the rotation reaches 180°, thus changing twice during a complete revolution. The usual colours observed are red, green, orange, blue. But a block composed of small pieces of amber, pressed together so as to coalesce, always shows bright interference bands, both adjacent and often intermixed, varying according to the size of the constituent fragmentary particles. Thus, all shades of colour are often to be seen in the field at once, which, on the polariscope being rotated through 90°, change into their complementaries.

In the more dull and opaque forms of amber, this system of differentiation cannot be brought to bear with such easy and decisive

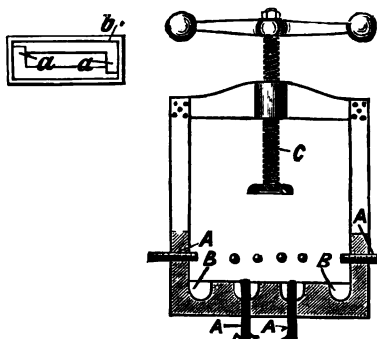

FIG. 1.—Hot Press for consolidation of Amber waste.

results. But advantage is taken of the fact that all cloudy and opaque kinds of amber exhibit under the microscope numerous round, oval or elongated cavities of various sizes and shapes. The size, position and number of these differ much, and are the cause of the different qualities of commercial clouded amber. Under the heavy pressure employed in making the blocks, up to 3,000 atmospheres, these cavities are compressed, and viewed under the microscope exhibit a flattened dendritic appearance. Again, clouded, pressed amber can be differentiated by the more cloudy appearance of its clear matrix, the turbid portion being apparently arranged in parallel strips like cirrus clouds. The yellowish-red hue, produced by transmitted light at the planes of transition between the bright and the clouded portions, and the bluish lustre or fluorescent bloom by reflected light, with dark background, are shown in much bolder relief by the extremely fine cavities than with a genuine lump of natural amber.

*Destructive Distillation Products of Amber.*—When destructively distilled amber yields (1) an acid liquor, containing acetic and succinic acids, (2) crystals of solid succinic acid next form in the neck of the retort, and then (3) a disagreeable smelling oil, amber oil, comes over. When the operation is stopped at this stage there is left in the retort (4) a more or less brown resin pyrosuccin (fused amber) which is used in the manufacture of varnish by incorporating it whilst still hot and fluid with linseed oil hot enough not to lower it to its solidifying-point. The more the attention given to the action of the heat and the more skill displayed in stopping it at the proper stage, the finer, brighter and lighter coloured is the residual resin and the varnish made therefrom. Amber oil as it comes over first is like rosin oil, thin and yellow, but soon darkens, becoming brown and viscous; the more quickly it is refined (see p. 19), the better is the result. If the heating of the amber be prolonged after the stage necessary to leave a residue fit for use in oil varnish-making, a volatile product passes over to which Berzelius gave the name of crystallised pyretine, but Gmelin that of amber camphor. It is in fact identical with Borneo camphor,  $C_{10}H_{18}O_2$ , the product of the *Drybalonops aromatica*.

Berthelot and Buignet, who isolated this camphor from amber by distillation with potash lye, a method previously used to isolate it by Reich in 1849, made an elementary analysis of it, determined its specific refraction, establishing its alcoholic nature, and finally its identity with borneol. According to Marson, amber gives off, during dry distillation, the following volatile products: carbonic acid, butyric acid, metacetic acid, acetic acid, capronic acid, valerianic acid. As to the source of the succinic acid in amber, Reich long ago made the interesting observation that all the lignites, fossil pine cones and brown coal of Samland contain succinic acid. The ash of amber only amounts to 0.08 to 0.12 per cent., and consists of carbonate of lime, silica, oxide of iron and sulphuric acid.

TABLE II.—SHOWING THE ULTIMATE COMPOSITION OF DIFFERENT LAYERS OF THE SAME PIECE OF AMBER (SUCCINIT) PER CENT.

| Layer.                      | C     | H     | O     | S    |
|-----------------------------|-------|-------|-------|------|
| Bright kernel . . . . .     | 78.63 | 10.48 | 10.47 | 0.42 |
| Inner red crust . . . . .   | 74.36 | 9.94  | 15.34 | 0.36 |
| Outer brown crust . . . . . | 66.91 | 9.16  | 23.67 | 0.26 |

TABLE III.—SHOWING THE ULTIMATE COMPOSITION OF OTHER VARIETIES OF AMBER (BONE AMBER, CHALK AMBER).

|                       | C     | H    | O     | S    |
|-----------------------|-------|------|-------|------|
| Bone amber . . . . .  | 75.70 | 9.45 | 14.51 | 0.34 |
| Bone crust . . . . .  | 74.25 | 9.01 | 16.44 | 0.30 |
| Chalk amber . . . . . | 73.68 | 9.94 | 16.27 | 0.11 |

Amber oil, according to Jolles, may be bleached as follows. The 5 to 6 per cent. of amber oil yielded by the dry distillation of amber is freed from water, and the 2 per cent. of succinic acid which accompanies it by deposition. The oil floats to the top, whilst the succinic acid forms an intermediate layer between the oil and the water. The oil is then syphoned off. It is a strong-smelling fluorescent viscous liquid. Its ultimate analysis proves it to be a compound of carbon, hydrogen, oxygen and sulphur, but it is free from nitrogen. When heated with lead salts it yields a precipitate of black-lead sulphide. Neither dilute nor concentrated hydrochloric acid acts to any extent on amber oil, no more do dilute sulphuric or nitric acids even on heating. Fuming nitric acid decomposes amber oil with great energy, with evolution of nitrous fumes, and formation of much succinic acid with, simultaneously, a reddish-yellow balsamic resin, having a musk-like odour, and often sold as artificial musk. Alkalies appear to have no action on either the colour or the smell of the oil. Reducing agents, such as sulphur, zinc chloride, sodium thiosulphate, which have generally a marked action on vegetable oils, do not in any way affect amber oil, neither do oxidising agents such as chlorine have any action either upon the smell or the colour of the oil; and although both permanganate and bichromate mixtures are reduced, the colour of the oil is not affected. Better results are obtained by rectifying the oil. When amber oil is distilled, water comes over first, then a yellow oil, followed by a light green oil, and finally a dark green viscous oil. As soon as the water has distilled over, the thermometer rises very quickly to 150° C., and keeps on rising until the distillation finishes at 360° C., only remaining stationary for brief periods at 230° and 255° C. The pitchy residue amounts to about 10 to 15 per cent. Practically

identical products are obtained, and in the same order, by distillation *in vacuo*. The following results were obtained by fractional distillation:—

TABLE IV.—SHOWING FRACTIONAL DISTILLATION PRODUCTS OF AMBER OIL.

| Temperature. | Description of Oil. | Percentage of Total Distillate. |
|--------------|---------------------|---------------------------------|
| 130-180° C.  | Light yellow        | 33                              |
| 180-300° C.  | Light green         | 45                              |
| 300-360° C.  | Dark green          | 15                              |

The yellow oil still retains its offensive odour, but this is removed when the crude amber oil is distilled in a current of steam. When steam is passed through amber oil undergoing distillation with half its volume of water, the steam carries over and dissipates the offensive vapour. The yield of rectified inodorous yellow oil is 38 per cent. of the crude. Distillation from a 10 per cent. alkaline solution has no effect upon the yellow oil distillate, but removes the offensive smell from the residue in the still, which is separated from the emulsion formed in the process by salting out, after which its odour is pleasant.

*Solubility.*—Amber is almost entirely insoluble in water, ammonia, benzol, petroleum spirit, acetic acid, carbon disulphide, essential and fixed oils. If finely pulverised and then heated with alcohol, ether, chloroform, benzene, spirits of turpentine, it swells, but dissolves only very sparingly. In alcohol containing a little camphor it seems to dissolve slightly. It is said to dissolve in a mixture of alcohol and spirits of turpentine, heated in a closed vessel. If amber be treated in the manner described under "Destructive Distillation Products," the residual resin dissolves easily in all the solvents used in the manufacture of both spirit and oil varnishes, and consequently in hot linseed oil. Helm obtained the following results:—

TABLE V.—SHOWING THE SOLUBILITY OF VARIETIES OF AMBER IN DIFFERENT SOLVENTS.

| Solvent.                        | Murber Bernstein,<br>per cent. | Gedanit,<br>per cent. | Succinit,<br>per cent. |
|---------------------------------|--------------------------------|-----------------------|------------------------|
| Alcohol . . . . .               | 30                             | 42                    | 20.25                  |
| Ether . . . . .                 | 53                             | 63                    | 18.23                  |
| Chloroform . . . . .            | 33                             | 45                    | 20.6                   |
| Benzol . . . . .                | 38                             | 42                    | 9.8                    |
| Carbon disulphide . . . . .     | 39                             | 58                    | 24.0                   |
| Spirits of turpentine . . . . . | 45                             | 58                    | 25.0                   |
| Linseed oil . . . . .           | 38                             | 100                   | 18.0                   |

(1) *Comparative composition* (1) of the portion of Amber soluble in Alcohol and (2) of the portion insoluble therein.—Tschirsch extracted pulverised amber with 96 per cent. alcohol for a week, in a sheet metal vessel of the Soxhlet type, but larger, 50 cm. high and



20 cm. broad. The amber was not placed in a "cartridge case" but run into the apparatus through a funnel, bored into it for the purpose. The alcohol dissolved 30 per cent. and left 70 per cent. undissolved (*succinin*). A series of experiments demonstrated that the borneol is contained in the portion soluble in alcohol, the succinic acid in the portion insoluble in alcohol, and the sulphur in both the soluble and insoluble portions. On boiling the succinin with alcoholic potash a solution was obtained which gave a black precipitate with lead acetate. On the other hand, the alcoholic extract, when fused with sodium yields the sulphur reaction with sodium nitro-prusside. Amber (*succinit*) contains no free succinic acid. Finely pulverised amber (*succinit*) was digested with water at 30° C. (86° F.) for a month. The water took up no succinic acid and exhibited no acid reaction. Moreover, a 1 per cent. soda solution, even on prolonged contact, extracted no succinic acid. The alcoholic extract leaves a resin with a strongly acid reaction, which, strongly heated, gives off the smell of borneol. When the alcoholic solution is exactly neutralised by potash and the alcohol boiled off there is left a resin soap, soluble in water to a clear solution, the greater bulk of which is precipitated on the addition of alkali. Acids, even CO<sub>2</sub>, precipitate a very acid body from the alcoholic solution. Petroleum ether (B.Pt. 50°C.) extracts a borneol compound from the alcohol extract. But the borneol compound may be better extracted directly from amber as follows. A large quantity of amber is finely pulverised and extracted with petroleum ether. This yields a neutral yellow body, soluble in 50 per. cent alcohol and 5 per cent. caustic soda lye, amounting to 2 per cent. of the amber, which, when heated with potash lye, gives off an intense odour of borneol. As the borneol is abundantly present in the substance, it is distilled with 5 per cent. potash lye in a vessel connected with a condenser and receiver. The borneol passes over with the distillate, from which it may be extracted by agitation with petroleum ether. No fatty acids are present in the liquid in the retort (distillation with phosphoric acid yields a neutral distillate), in which there now only remains a pure resin, with an acid reaction, an acid resin, *succino-abietinic* acid. It is the acid formerly combined with the borneol. Hence the substance extracted from amber by petroleum ether is borneol-succino-abietinic-acid-ester. It is present to the extent of 2 per cent. in amber. To identify the borneol a larger amount was prepared. Three kilogrammes of amber were distilled with 750 grammes of caustic potash and a sufficiency of water. A portion of the borneol passes over with the distillate from which it is extracted by petroleum ether. The largest portion solidifies in the condenser tube, from which it is extracted by solution in petroleum ether. The united extracts yielded 7 grammes of borneol in colourless six-sided plates. By crystallisation from ether and sublimation, a substance fit for analysis was obtained, melting at 184° C. and is in complete fusion before sublimation—distinction from iso-borneol. It deviates strongly to the right, and on combustion gave the following results: Found C = 77.69, H = 11.74.

Calculated (for  $C_{10}H_{18}O$ )  $C = 77.92$ ,  $H = 11.68$ . The molecular weight estimation gave 156.5. The formula  $C_{10}H_{18}O$  requires 154. By applying the chloral test of Bertram and Walbaum for iso-borneol, it is found that amber borneol is not iso-borneol. It is dextro-borneol. Borneol (and also levo-borneol, as acetic acid ester) occurs in appreciable quantity in coniferous oils, as also in the essential oil from the forest pine, the hemlock spruce, the black fir, the Siberian fir and the balsam fir, so we may take it that in the borneol-succino-abietinic-acid-ester we get the last residue of the essential oil of the amber pine. The quantitative abstraction of the borneol ester from the free resin acids in the alcoholic extract from amber is difficultly effected by petroleum ether. It is better to dissolve the residue from the alcoholic extraction in 70 per cent. alcohol to which some caustic potash has been added and then to add dilute sulphuric acid. The resin acids are eliminated and the borneol ester remains with some resin acid in solution. The process, several times repeated, yields eventually a resin acid quite free from borneol ester, succino-abietinic acid.

The latter, difficultly crystallisable, is present to the extent of 28 per cent. in amber. Besides it contains an obstinate sulphur compound, which lowers the melting-point. The best results are got by passing dry hydrochloric acid gas into it. The resulting acid so prepared is not yet colourless. The perfectly white acid is difficult to prepare. Dried at  $105^{\circ}C$ . it melts at  $145^{\circ}C$ . It dissolves in alcohol, ether, chloroform, but not in petroleum ether. A lead chromate combustion of the amorphous acid gave the following results: Found mean of six analyses,  $C = 82.47$ ,  $H = 10.63$ . Calculated for  $C_{80}H_{120}O_5$ ,  $C = 82.76$ ,  $H = 10.34$  per cent. Crystalline *succino-abietinic* acid melts at  $148^{\circ}C$ . It gave the following results: Found  $C = 82.71$ ,  $H = 10.41$ . Calculated for  $C_{80}H_{120}O_5$ ,  $C = 82.76$ ,  $H = 10.34$ . Titration with  $KHO$  (for  $2KHO = 112$ ) gave the value 1152, the formula  $C_{80}H_{118}K_2O_5$  requires 1160. If the neutral solution of the potash salt of succino-abietinic acid be precipitated by a 3 per cent. alcoholic solution of silver nitrate, a colourless amorphous silver salt is obtained, which, dried at  $105^{\circ}C$ ., yielded on analysis: Found  $Ag = 15.80$ ,  $15.85$ . Calculated for  $C_{80}H_{118}Ag_2O_5 = 15.72$  per cent. Elementary analysis with lead chromate and potassic chromate gave mean of three analyses,  $C = 69.57$ ,  $H = 8.80$ . Calculated for  $C_{80}H_{118}Ag_2O_5$ ,  $C = 69.87$ ,  $H = 8.59$  per cent. Hence succino-abietinic acid is a dibasic acid. The lead salt prepared in the same way showed such a high lead content as to point to the formation of a basic salt. Pure succino-abietinic acid dissolves in a dilute solution of carbonate of potash. With the Liebermann-cholesterol reaction the acid becomes pale reddish-brown. With the Salkowsky-Hesse reaction the chloroform turns yellow, the sulphuric acid reddish-brown and fluorescent. If succino-abietinic acid be heated with 5 per cent. alcoholic potash for an hour, in a vessel attached to a reflux condenser, it is split up into the resin acid, succino-sylvinic acid, and a resinol, *succino-abietol*. The solution is diluted with six times its volume of water

which produces a precipitate, and the alkaline solution filtered out yields with dilute  $H_2SO_4$  a gelatinous precipitate of an acid nature, *succino-sylvinic* acid, very readily soluble in alcohol, ether, acetic acid and dilute carbonate of potash. Carbonic acid gives no precipitate from its alkaline salts—distinction from succino-abietinic acid. It could not be crystallised, it melted at  $95^\circ C.$ , and a combustion with lead chromate gave the following results: Found mean of three analyses,  $C = 80.84$ ,  $H = 10.18$  per cent. Calculated for  $C_{24}H_{36}O_2$ ,  $C = 80.90$ ,  $H = 10.11$  per cent. Titration with KHO gave (for  $1KHO = 56$ ) the value 358-360-361. The formula  $C_{24}H_{36}KO_2$  requires 356. The potassium salt may be prepared by neutralising the acid alcoholic solution with potassium carbonate evaporating to dryness and extracting the residue with 96 per cent. alcohol. By precipitating the solution of the potassium salt by silver nitrate a silver salt was prepared which dried at  $105^\circ C.$ , and a combustion thereof effected with lead chromate and potassium bi-chromate gave the following results: Found mean of three analyses,  $C = 61.91$ ,  $H = 7.77$ . Calculated for  $C_{24}H_{36}AgO_2$ ,  $C = 62.2$ ,  $H = 7.56$  per cent. The silver estimation gave  $Ag = 23.8$ . Calculated for  $C_{24}H_{36}AgO_2 = 23.33$  per cent.

On treating the alcoholic potash reaction products with water a precipitate is produced which still contains succino-abietinic acid. Treated with water it gives a cloudy solution. On acidifying the solution by sulphuric acid, a precipitate falls consisting of succino-abietinic acid and succino-abietol which are easily separated; the precipitate is dissolved in ether, and treated with a 1 per cent. solution of  $K_2CO_3$  until no more succino-abietinic acid is extracted and the extraction completed by treatment with a 1 per cent. solution of caustic potash. The succino-abietol remains in solution in the ether. It dissolves easily in alcohol and chloroform but is insoluble in petroleum ether; the alcohol solution yields a dazzling white precipitate on the addition of water which may be got in the crystalline form by cooling with ice. Succino-abietol forms alkaline compounds, melts at  $124^\circ C.$  and gives in a lead chromate combustion the following results: Found mean of four analyses,  $C = 83.68$ ,  $H = 10.61$ . Calculated for  $C_{20}H_{30}O$ ,  $C = 83.92$ ,  $H = 10.49$  per cent. The molecular weight estimation gave 584 and 577. The double formula  $C_{40}H_{60}O_2$  requires 572. The formula of *succino-abietol* shows a connection with *pimaric* acid. Under the action of the Salkowsky-Hesse test, it colours the chloroform yellowish-red, the sulphuric acid blood-red, and exhibits fluorescence. On boiling with acetic anhydride with a reflux condenser, succino-abietol is acetylated. The acetyl derivative is soluble in petroleum ether, and can be crystallised from dilute alcohol by cooling with ice. It melts at  $92^\circ C.$  The molecular weight estimation, as well as saponification by  $n/10$  alcoholic potash and back titration, shows that the formula of the acetyl derivative very probably is  $C_{40}H_{58}O_2(CH_3CO)_2$ , so that in *succino-abietol* there are two hydroxyls,  $C_{40}H_{58}(OH)_2$ . Prepared as a bye-product from alcoholic potash it contains no entrained *succino-abietinic* acid and is very pure.

*Succino-abietinic* acid may be acetylated by acetyl chloride. The acetyl derivative is soluble in potassium carbonate but is somewhat impure. It exhibits a hydroxyl group, so the provisional formula of succino-abietinic acid may be written  $C_{78}H_{117}OH(COOH)_2$ . But further investigation is necessary. The succino-abietinic acid separated from the borneol ester and the free succino-abietinic acid have the same peculiarity. The solutions of their alkaline salts are both precipitated by carbonic acid, or even by excess of alkali. Heated by alcoholic potash, they are resolved into *succino-sylvinic* acid and succino-abietol. On very cautious fusion with caustic potash (not by treatment with alcoholic potash) it yields succinic acid. Abietinic acid is likewise produced. It may be separated from the succinic acid by cautious fusion. In the alcoholic solution of amber there is thus a small quantity of succino-abietinic-acid-borneol-ester, but it consists mainly of free succino-abietinic acid. There are also traces of an organic compound containing sulphur. Succinic acid is absent.

(2) *Succinin*.—The portion of amber insoluble in alcohol, the succinin of Berzelius, is only slightly soluble in chloroform and carbon di-sulphide. It contains succinic acid as an ester compound. As succinin cannot be brought into solution it was therefore directly saponified with 0.5 per cent. alcoholic potash, at room temperature.

The residue was extracted with water, all the extracts, which must contain the potassium salts of succinic acid, were mixed, the alcohol distilled, the alkaline solution acidulated with sulphuric acid, filtered, evaporated nearly to dryness, and the residue extracted with 96 per cent. alcohol. Potassium sulphate remained as a residue, the succinic acid was dissolved and was easily crystallised. When freshly crystallised the succinic acid melted at  $180^{\circ}C$ . and on combustion yielded: Found  $C = 40.60$ ,  $H = 5.39$ . Calculated for  $C_4H_6O_4$ ,  $C = 40.68$ ,  $H = 5.08$  per cent. The substance was also identified as succinic acid.

The residue left on the filter from the washing of the potassium succinate consisted of the potassium salt of the substance in combination with the succinic acid, which is very slightly soluble in alcohol, but is more soluble in warm dilute alcoholic potash. It is run into ether-alcohol (2 : 1), sulphuric acid added to separate potassium sulphate and dissolve the resin alcohol, which is obtained as a residue by distilling off the ether-alcohol.

The succino-resinol separates when 80 per cent. alcohol is added to its solution in ether-alcohol as a permanent turbidity, which filtered off yields a white powder melting at  $275^{\circ}C$ . insoluble in alcohol, ether, chloroform or benzol, but soluble in ether-alcohol. It still retains sulphur very obstinately. A sulphur estimation gave 0.466 per cent. S. It is probably due to the presence of a minimum quantity of an organic sulphur compound.

On combustion with lead chromate the following results were obtained: Found mean of three analyses,  $C = 80.46$ ,  $H = 11.02$ . Cal-

culated for  $C_{12}H_{20}O$ , C = 80.00, H = 11.11 per cent. On testing with the Salkowsky-Hesse reaction the chloroform within a certain time becomes bluish, the sulphuric acid pale brown, fluorescent. Under the Liebermann-cholesterol reaction succino-resinol becomes brown. It can be acetylated. The acetyl derivative is soluble in ether and contains 4.9 per cent. of acetic acid. It could not be crystallised. The succino-resinol potassium compound which separates as a white resin soap by adding potassium hydrate to an alkaline alcoholic solution of succino-resinol, contains 2.6 per cent. of potassium. On fusion with potash succino-resinol yields fatty acids. A quantitative estimation of succinic acid in succinin gave 7.8 per cent., which shows that succino-resinol must have a high molecular weight. In molecular estimation tests the depression is found to be of an extraordinary nature. The succinic acid ester of succino-resinol, which constitutes the greater proportion of succinin, forms 70 per cent. of

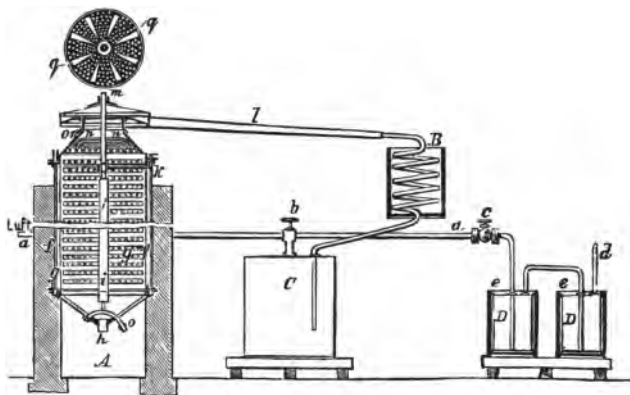

FIG. 2.—Borowski's plant for fusing and dissolving Amber.

amber. The dry distillation of amber yields 3 to 8 per cent. of succinic acid, which agrees with theory. The exact proportion of this ester yielded by succinin is uncertain.

#### AMBER-OIL VARNISH.

*Borowski's method of fusing and dissolving amber* consists in highly diluting the molten amber with turpentine, removing the impurities by settling or filtration and distilling off the diluting material. Fig. 2 shows a cross-section of the apparatus, A being the distilling apparatus, B the refrigerator, C the tank for the turpentine distillate, and D, D reservoirs for amber oil. The pipe *a* is provided with a strong air-injector to aspirate the air from its interior. While melting the amber the valve *b* is shut and valve *c* open. The pipe *l* has an open end under the hood above the melting furnace, and by working the injector the vapours from the furnace are drawn in and condensed in the tanks D, D, which are surrounded by cold water.

As the succinic acid condenses in the pipe *l* it is preferable to make all bends sharp-cornered. The molten amber, having been diluted with turpentine, is introduced into A through the pipe *m*, which is bent several times to exclude air. Pipes *n, n* distribute the solution on to the uppermost of a set of perforated round plates, *q*, with raised edges provided with small pipes in the perforations for the passage of the liquor and with slots for the passage of the air. Steam is admitted between the walls of the double cylinder, *f, f*, on the top of which is a stillhead, and the conical bottom has an aperture, *h*, through which air enters and the concentrated solution of amber is discharged. The air saturated with turpentine vapour pushes through the pipe *l* and cooling worm, B, into the reservoir, *c*, where the turpentine remains while the air follows the draught of the injector through pipe *a*. Instead of using an injector the air can be forced into the apparatus, A, by a ventilator. In that case the aperture, H, is closed and the liquor within withdrawn from time to time.

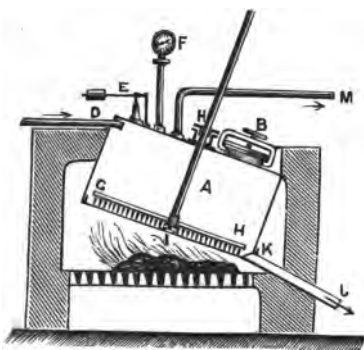

FIG. 3.—Plant for "Running" Amber for Varnish-making (fire heated).

Owing to the high price of the hardest and finest copals attempts have often been made to substitute amber for them. But although amber yields varnishes of great hardness and durability, it has the great disadvantage of darkening on heating, especially towards the end of the operation. Hence this operation has been conducted in several successive stages, at the end of each of which the soluble portions are extracted with spirits of turpentine, the product of the first stages being lighter in colour than of those later on. But this process would only be applicable on the small scale. Schrader and Dumeke have, however, devised an apparatus, which in one single operation accomplishes the object in view, and in which over half a ton of amber can be treated in one operation. The amber is melted in a cylindrical boiler, A, Fig. 3, fixed above a furnace built of masonry, and inclined in such a manner that the products as they melt run away by a discharge tube, L, connected with the lowest portion of the sloped bottom of the boiler, whilst the vapours escape through M to a condenser connected with the top so as to avoid all oxidation steam at a pressure of one or two atmospheres, or other inert gas, such as carbonic acid or nitrogen, is injected through D into the boiler to displace the air; then after a sufficient interval, indicated by experience, the melted products are run off, thus avoiding the high temperature necessary to fuse the whole mass; the melted products run directly into closed receivers fitted with a disengagement tube for the escape

of air and vapour. A gauge glass, F, indicates the pressure; E is safety valve; B is the charging manhole; G, H is the stirrer.

Fig. 4 shows a similar apparatus heated by a gas fire. Three grades of fused amber are obtained in this manner, *viz.*, 30 per cent. of very bright and lustrous resin, 60 per cent. good resin, very hard, 10 per cent. dark-coloured resin. Whatever method is employed the action of heat on hard resins renders them easily soluble in the different solvents, and the resultant varnish is so much the better in quality the more care and skill has been displayed in the operation, and in the choice of resin submitted thereto.

According to Halphen oil varnishes made with amber are prepared almost in the same fashion as the copal varnishes; that is to say, the amber must be submitted to the action of fire until it

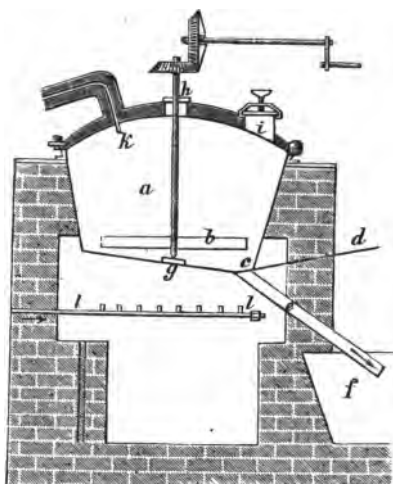

FIG. 4.—Plant for "Running" Amber for Varnish-making (gas heated).

has lost about half its weight. Nevertheless, the method of manufacture differs in that the oil is not poured on the amber in a state of fusion. What is known as the German method is as follows. The pounded and sieved amber is put into a cast-iron pot with a flat bottom, which is just covered over with the material, and this is held over the fire until the amber is thoroughly melted and is quite liquid. It is then run in thin coats on to a cast-iron plate, and after this quick re-cooling it is broken up into small pieces. In this state it is soluble in varnish oils. When the fusion has been well done the fracture of the amber should be half as brilliant as that of the primitive material. The varnish oil is prepared apart by boiling until a pellicle forms a mixture of 5 lb. of litharge, pulverised and sieved,  $1\frac{1}{4}$  grammes of powdered sulphate of zinc, and 10 gallons of linseed oil. A mixture of 1 part of the prepared amber with 3 parts of this varnish oil is put into a cast-iron pot and heated until the amber

disappears. Four parts of spirits of turpentine are then added, and the mixture is filtered.

*Amber-Oil Varnishes.*—These are the hardest varnishes known, but on the other hand they are wanting in elasticity; they are thus used to cover surfaces little subject to vibration or to bending motion. They answer remarkably well for such comparatively inflexible substances as glass. Owing to the high temperature at which amber melts, and also to the different pieces not melting at the same temperature, amber-oil varnishes are generally dark in colour. The relative proportions of the ingredients usually taken are: Fused amber, 10 lb.; boiled linseed oil, 8 to 30 lb.; spirits of turpentine, 10 to 25 lb. The quantity of linseed oil varies from 8 lb. if hardness be required to 30 lb. when elasticity is a desideratum. The quantity of spirits of turpentine is regulated by the degree of fluidity. If hardness and transparency and a quick-drying varnish be required in preference to elasticity, the amber is largely increased, and a very volatile solvent such as benzene is employed, say: Fused amber, 10 lb.; linseed oil, 2½ lb.; benzene, 5 lb. Finally, it is often advantageous whilst taking advantage of the hardness of amber with the view of increasing its elasticity without very appreciably impairing its hardness to replace a part of the amber by copal, say: Fused amber and copal equal parts, 1 lb.; boiled linseed oil, 1 lb.; spirits of turpentine, 2 lb. The result is a hard durable elastic varnish. In cheaper varnishes the whole of the copal in the above may be replaced by carefully selected higher grade rosin.

*Golden Oil Varnish* into which amber enters is made thus: Amber, 8 lb.; seed lac, 2 lb.; linseed oil, 8 lb.; spirits of turpentine, 16 lb. The coloration is imparted by a solution of dragon's-blood, gamboge, annatto and saffron in spirits of turpentine.

*Rosin and Amber-Oil Varnish.*—Fused amber, 84 lb.; boiled oil, 100 lb.; rosin, 16 lb.; spirits of turpentine, 100 lb.

*Pale Amber Varnish.*—Fuse 6 lb. of fine picked very pale transparent amber in the gum-pot and pour in 2 gallons of hot clarified oil. Boil until it strings very strong. Mix with 4 gallons of turpentine. This will be as fine as body copal, will work very free and flow well upon any work it is applied to. It becomes very hard and is the most durable of all varnishes; it is very excellent to mix in copal varnishes to give them a hard and durable quality. Amber varnish will always require a long time before it is ready for polishing.

TABLE VI.—SHOWING THE RELATIVE PROPORTION OF THE DIFFERENT INGREDIENTS USED IN MAKING AMBER OIL VARNISHES.

| Amber. | Raw Oil. | Turps. | Amber. | Boiled Oil. | Turps. |
|--------|----------|--------|--------|-------------|--------|
| 1b.    | 1b.      | 1b.    | 1b.    | 1b.         | 1b.    |
| 100    | 190      | 390    | 100    | 100         | 290    |
| 100    | 150      | 370    | 100    | 70          | 270    |
| 100    | 100      | 300    | 100    | 40          | 250    |



TABLE VII.—SHOWING THE RELATIVE PROPORTION OF THE DIFFERENT INGREDIENTS IN MAKING PYROSUCCIN OIL VARNISHES.

|                     | A.    | B.    | C.  | D.  | E.  | F.      | G.         | H.    | I.  | J.      |
|---------------------|-------|-------|-----|-----|-----|---------|------------|-------|-----|---------|
| Quality of amber .  | 1     | 2     | 1   | 3   | 1   | 0       | 3          | Prima | —   | —       |
|                     | lb.   | lb.   | lb. | lb. | lb. | lb.     | lb.        | lb.   | lb. | lb.     |
| Pyrosuccin . . .    | 500   | 500   | 500 | 500 | 500 | 500     | 500        | 500   | 500 | 500     |
| Double boiled oil . | 750   | 750   | 130 | 130 | 170 | 120     | 240        | 180   | 150 | 120     |
| Manganese dioxide   | 17½   | 17½   | 10  | 10  | 10  | 7½      | 7½         | 7½    | 10  | 7½      |
| Turps . . . . .     | 1,200 | 1,200 | 570 | 750 | 780 | 700-730 | 1,600-1700 | 850   | 780 | 700-750 |

A, Coach Varnish ; B, Coach Iron Work ; C, Furniture I. ; D, Furniture II. ; E, Final Coat ; F, Table I. ; G, Table II. ; H, Tinware ; I, Floor I. ; J, Floor II.

## CHAPTER III.

### ASPHALTUM, COAL-TAR PITCH, RUBBER, ETC.

ASPHALTUM. (Synonyms: *Bitumen*, *Mineral Pitch*; Greek, *Asphaltos*; Latin, *Bitumen Judaicum*, *Judaicus lapis*; French, *Asphalte*, *Bitume de Judée*; German, *Asphalt*, *Erdpech*, *Judenpech*.) The properties and application of asphaltum were well known to the ancients, Noah being instructed to "pitch it (the ark) within and without with pitch" (Gen. v. 14). Its qualities and uses were thus well understood at that early date. At the building of the tower of Babel "they had brick for stone, and slime (no doubt asphaltum) had they for mortar". Again (Exod. ii. 3), "when Moses' mother could no longer hide him, she took for him an ark of bulrushes, and daubed it with slime (Revised Version, bitumen) and with pitch". Again, asphaltum was used as the consolidating agent in the building of Nineveh as well as in that of all the other Assyrian edifices. Coming, however, to times less remote, we find Dioscorides informing us that "the best (asphaltum) is from Judæa," whilst Pliny (xxxv. 15) tells us that it comes from the Dead Sea ("*E Judæa lacu ut diximus emergens*"), and that good bitumen is known by its weight and glossy fracture ("*Bituminis probatis ut quam maxime splendeat sitque ponderosum ac grave*"), and that there is also a bituminous earth or mineral from Sidon ("*Terra in Syria circa Sidonem oppidum maritimum*"). Moreover, jet, which occurs naturally on our own Yorkshire shores at Whitby, was even then known to be related to asphaltum, for Dioscorides, Pliny and Orpheus tell us that *gagates* is another stone (*jet*) that is bituminous and inflammable, from the mouth of the river Gages, in Lycia. Dioscorides also refers to another variety, the Thracian stone, which is found in Scythia. Finally, Dioscorides and Pliny mention that "Ampelitis is an earth like bitumen; when good, it will dissolve freely in oil like wax" ("*Bitumini simillima est ampelitis experimentum ejus, si cera modo accepto oleo liquescat*"). Moreover, it would appear that the Greeks were able, in a certain way, to differentiate between crude bituminous petroleum and asphaltum. Both Dioscorides and Pliny describe liquid bitumen as *Pissasphaltum*: "*Est vero liquidum bitumen sicut Zacynthium et quod a Babylone invehitur. Liquidum est et Appoloniaticum quæ omnia Græci pissasphaltum appellant ex argumento picis et bitumenis*" ("There is a liquid bitumen from Zante and from Babylon, also from Appolonia, all which the Greeks call *pissasphaltum*"),

because of their consisting of pitch and bitumen. Their knowledge went still farther; they even burnt a similar kind in their lamps. "There is a similar kind at Agrigentum in Sicily, which they burn in lamps" (*"Gignitur etiam pingue liquorisque oleacei in Sicilia Agragantino fonte inficiens rivam"*—*"Utuntur eo ad lucernarum lumina olei vice"*). But solid asphaltum or bitumen proper, the solidified form of petroleum, a condition brought about by the prolonged concentrated action of the sun's rays, together with the action of the air on the original liquid petroleum, was the form utilised the most by the ancients. They not only used it for building purposes, but also for the construction of pavements similar to those which we still lay down at the present day. Perhaps the most extensive use was in the religious or sentimental process of embalming the dead, or, in other words, the preservation of the human body from decay and putrefaction, an art in which Egypt excelled the whole world, ancient and modern. The dry climate no doubt aided the practitioners in their task, but even making due allowance therefor, the operation was thoroughly well done. Mummy brown consists partly of asphaltum.

The term "asphaltum" should be used to designate (1) natural asphaltum, which is almost entirely soluble in benzol, contains considerable quantities of sulphur (1.5-10 per cent.), and is employed for building purposes, for protecting articles from damp, for the manufacture of varnishes, etc. (2) Those substances artificially obtained as residues by the distillation of mineral tar, coal tar, wood tar, lignite tar, petroleum and shale oil, which are in appearance, and also to some extent in their chemical and physical properties, similar to natural asphaltum, and may be used as a substitute for this, should most certainly be marked in such a way by those persons or firms bringing the asphaltum into the market, that they may be easily distinguished from natural asphaltum. This demand appears to be imperative and ought eventually to be supplied by suitable arrangements, because on the one hand the investigation as to the origin is very difficult (in practice, is found in the majority of cases to be impossible), and on the other hand opinions differ very widely as to the suitability for technical purposes of the various natural and artificial asphaltums.

To the already well-known qualitative methods of distinction the following may be added. On the addition of petroleum spirit to a chloroform solution of coal-tar pitch a precipitate is formed, which is not the case with natural or petroleum asphaltums. It is not, however, found possible to distinguish quantitatively between "natural asphaltums" and "petroleum asphaltum" obtained from petroleum. These two classes of products are apparently too closely related to one another, and under the investigated conditions the figures obtained for the individual members appeared to be quite arbitrary. This can scarcely be wondered at, as it is a generally accepted view that the "asphaltums" (semi-solid or solid "natural asphaltums") found in nature mixed with more or less mineral and

other impurities, stand in very close relationship to the more or less liquid petroleum, and are formed from these by analogous processes to those by which "petroleum asphaltum" is prepared artificially from the oils.

ELEMENTARY COMPOSITION OF ASPHALTUM FROM VARIOUS SOURCES.

| Source.                     | Carbon | Hydro-gen. | Oxygen | Nitro-gen. | Sulphur. | Ash.  | Density. | Melting-point. | Analyst.      |
|-----------------------------|--------|------------|--------|------------|----------|-------|----------|----------------|---------------|
| Barbadoes . . . . .         | 87.4   | 9.56       | —      | —          | 2.67     | 0.24  | 1.040    | 110° C.        | Helm.         |
| Dead Sea . . . . .          | 80.00  | 9.00       | —      | 0.4        | 10       | 0.60  | 1.103    | 135 "          | "             |
| Trinidad . . . . .          | 78.80  | 9.80       | —      | 1.4        | 10       | 0.5   | —        | 130 "          | Bussengo.     |
| Fechelbronn . . . . .       | 86.98  | 11.90      | —      | —          | —        | —     | —        | —              | "             |
| " viscous . . . . .         | 88.40  | 12.70      | —      | Trace.     | —        | —     | —        | —              | "             |
| " white . . . . .           | 88.00  | 11.04      | —      | —          | —        | —     | —        | —              | "             |
| " 87.56                     | 12.35  | —          | —      | —          | —        | —     | —        | —              | Folkel.       |
| Pont Novet . . . . .        | 67.43  | 7.22       | 23.98  | 1.37       | —        | 15.83 | —        | —              | Ebelman.      |
| Pont de Glato . . . . .     | 76.13  | 9.41       | 10.33  | 2.37       | —        | 1.80  | —        | —              | "             |
| Auvergne . . . . .          | 77.64  | 7.86       | 8.36   | 1.02       | —        | 5.13  | —        | —              | "             |
| Naples . . . . .            | 81.83  | 8.28       | 8.83   | 1.06       | —        | 5.13  | —        | —              | "             |
| Cuba . . . . .              | 81.46  | 9.57       | 8.97   | —          | —        | —     | —        | —              | Regnault.     |
| " 75.85                     | 7.25   | —          | 12.96  | —          | —        | 3.94  | —        | —              | —             |
| " 82.34                     | 9.14   | —          | 6.25   | 1.90       | —        | —     | —        | —              | Werterin.     |
| Basines, French . . . . .   | 78.50  | 6.58       | 2.60   | 1.65       | —        | 8.45  | —        | —              | Ebelman.      |
| Bentheim, Hanover . . . . . | 86.68  | 9.30       | 2.82   | 0.65       | —        | 0.52  | —        | —              | "             |
| Coxitambo, Peru . . . . .   | 88.60  | 9.69       | 1.65   | —          | —        | —     | —        | —              | Bussengo.     |
| Maracabo . . . . .          | 81.60  | 9.60       | 5—8    | —          | —        | 0.34  | 1.09     | —              | Helm.         |
| Abruzzi, Italy . . . . .    | 77.64  | 7.86       | 8.35   | 1.06       | —        | 5.13  | —        | —              | Regnault.     |
| Mexico . . . . .            | 80.34  | 9.57       | 10.09  | —          | —        | —     | —        | —              | "             |
| Egyptian . . . . .          | 85.29  | 8.24       | 6.22   | 0.25       | —        | —     | —        | —              | Boussingault. |
| Syrian . . . . .            | 80.00  | 9.00       | —      | —          | 10       | 0.6   | —        | —              | R. Kayser.    |
| Trinidad . . . . .          | 78.80  | 9.30       | —      | 1.40       | 10       | 0.5   | —        | —              | "             |
| Pont du Château . . . . .   | 76.41  | 9.58       | 11.64  | 2.37       | —        | —     | —        | —              | Ebelman.      |
| Helten . . . . .            | 88.00  | 11.60      | —      | 0.40       | —        | —     | —        | —              | Boussingault. |

*Test.*—Dissolve the sample in carbon disulphide, evaporate the filtrate to dryness, and heat till the residue can be ground to a fine powder; 0.1 gramme of this powder is digested for twenty-four hours with 5 c.c. fuming sulphuric acid, then mixed slowly with 10 c.c. water, applying cooling agents, filtered, and diluted with 100 c.c. water. Pure asphaltum gives a colourless or pale yellow liquid; in presence of pitch or coal-tar it is dark brown or black. For the detection of tar-pitch in asphaltum, H. Hauschild heats the sample to 200° and

shakes it with 5 c.c. alcohol. If only 2 per cent. of pitch was present, the liquid has a distinct yellow colour with green fluorescence, which becomes more intense as the colour increases.

Asphaltum on distillation gives paraffin (Grahamite, Albertite, Gilsonite); asphaltum from the Dead Sea (shining pitch) on distillation does not give paraffin, but other hydrocarbons.

*Valuation of Asphaltum for Varnish-making Purposes* (Wilson Neil).—There are so many various qualities and descriptions of asphaltum that it is very difficult to distinguish the good from the bad. There is asphaltum from China, Egypt, France, Neufchatel and Naples, and many sorts now made in England. The best which I have found is a native mineral or genuine Egyptian asphaltum; it is black, glossy and heavy, and when rubbed upon a hot poker readily melts. It emits a very strong disagreeable smell like that of garlic or assafoetida. It will neither dissolve in oil, water nor turpentine. It is in general when imported covered with a coat of dust or clay and mixed with stones, gravel, etc. This Egyptian asphaltum must be fused, of which more hereafter. Next in goodness is the Naples, which resembles the other in its external qualities. It is much freer from dirt, will dissolve in oil, but it never yields that intense black oil, to the same quantity, as the real Egyptian. There are several varieties of Naples, French and German, which will all dissolve in oil, only I have always found the softest and most fluid the best, yet of late there is asphaltum made in England and particularly in London which comes very near in quality to the best French, Naples or German. It is the residuum left from the burning of rosin, pitch or linseed oil which the makers of lampblack burn for the purpose of condensing. Linseed oil burnt by itself produces scarcely any residuum, but when joined with rosin it leaves a very fine asphaltum not inferior to the best Egyptian. But the asphaltum from pitch is very inferior, as it is coarse, gravelly and never hardens properly. It has a brown hue or tint. As for the asphaltum made from gas tar it is unfit either for black Japan or Brunswick black and fit only for inferior purposes.

As already remarked, asphaltum is used in art painting. Pure asphaltum having a conchoidal fracture and a fine dark colour is ground to a fine powder and sold in that form as a pigment. It is used for water-colour painting, with spirits of wine as a vehicle. For oil painting a solution of asphaltum in alcohol is precipitated with water, and the fine precipitate is collected and dried. Natural asphaltum cannot be used as a pigment without preparation, as its colour, although an agreeable brown at first, soon passes over into a dirty grey. This inconvenience is due to the presence of oils, which are removed from it by the action of alcohol. Asphaltum pigment will not bear mixing with white. It can only be used alone as a transparent colour, or mixed with other similar colours, and it is specially used for toning down and for backgrounds. A fine asphaltum brown is obtained by treating asphalt with hot alcohol

and rubbing up the dried residue with oil. This asphaltum brown shows a beautiful full shade, and is easily and remuneratively made. Guegnat strongly disapproves of asphaltum in painting. He alleges that it spoiled the work of such early nineteenth-century masters as David.

#### COAL-TAR DISTILLATION.

*Elimination of Water.*—The tar must be freed from the ammoniacal liquor which it always contains in greater or less amount, the presence of which would interfere with the distillation. As the water and coal-tar oil distil simultaneously there is always a tendency to tumultuous ebullition, and the whole mass may be projected violently out of the still, accompanied by an explosion. When tar is left to stand for a long time, if it be not too thick and viscous, the ammoniacal liquor, which is only mechanically mixed or suspended, settles out. Being of less density than the tar it floats to the surface and may easily be drawn off. In several factories the tar is allowed to deposit in capacious tanks built at a level high enough for the tar to flow into the still. In some, however, the tanks are fitted with a steam coil, by means of which the tar is heated to the desired temperature so as to thin it down and thus facilitate the separation of the ammoniacal liquor. In cold weather the tar is heated in London to 70° F., in Paris to 16-17° C. (say 60·8° and 62·6° F.), and in German factories to 40° C. (say 104° F.).

*Distillation by Steam.*—This method is the one which most concerns the varnish-maker. The general practice, however, is to distil over a naked fire, and steam distillation is only adopted in certain localities, especially in Scotland, where it is exclusively employed. It is specially used where it is simply desired to free the tar from water, and to remove its most volatile constituents, so that the remainder may be used for coating and protecting wood, metals, etc., for impregnating bricks, or stones, or in the manufacture of roofing felt.

*Distillation over a Naked Fire.*—The most general method of distilling tar is over a naked fire. The end in view is to separate the volatile ingredients (the coal-tar oils) from the pitch, and at the same time to effect a preliminary separation of the distillates which come over at different temperatures so as to treat each of them separately. This, it will readily be seen, can only be done over a naked fire because the boiling-point of anthracene, the most valuable ingredient of coal-tar, is as high as 360° C. (680° F.). The forms of coal-tar stills are many and varied. Our illustration shows a horizontal still of simple construction. They are charged afresh with tar from the reservoir whilst still warm from the previous operation. The tar is either pumped directly into the still or is run in through a 6-inch pipe (G, Fig. 5) from an overhead reservoir. The great width of the pipe is to save time in charging the still. When the still is charged, all the

taps are closed and heat applied. In fact, the fire may be lit when the still is half full. The time occupied in distilling off the charge varies with the season and the size of the still. With small stills with a capacity of 5 tons about two hours are required, and with stills of greater capacity, say from 22 to 25 tons, five hours in summer and six hours in winter. But, previous to this, one or two hours after the fire has been lit, the tar commences to prime and to froth and the greater part of the ammoniacal liquor can be run off through an overflow tap. Generally the still is cut for the first time after water ceases to come over, and the first receiver therefore contains both ammoniacal liquor and coal-tar oils. The latter are termed in Britain first runnings, first light oils, crude naphtha.

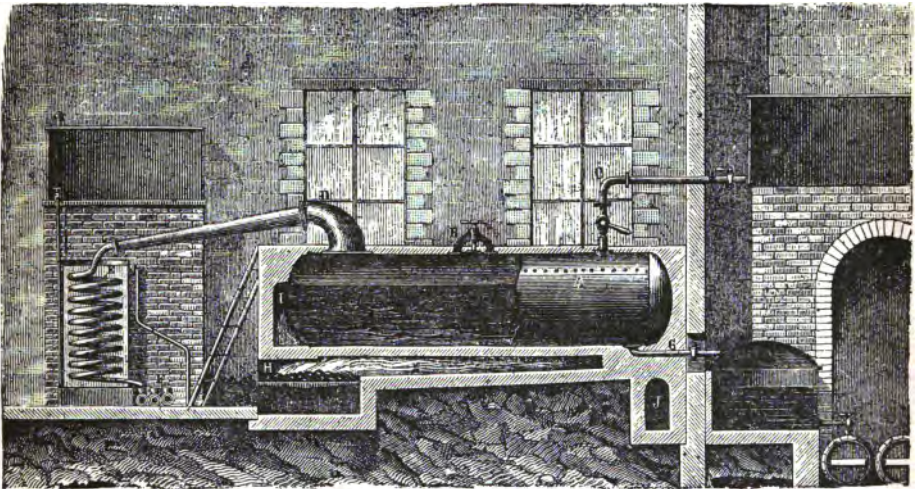

FIG. 5.—Coal-tar Still.

A, body of still; B, manhole; C, pipe for charging still from the reservoir; D, still-head; E, condenser; F, pipes through which different fractions are run off to respective receiving tanks; G, pipe through which pitch is run off and charged into barrels; H, fire-grate; J, flue and bridge to chimney; K, water tank.

The following are the temperatures at which the various fractions come over:—

|                          | °C.     | °F.     |
|--------------------------|---------|---------|
| Naphtha . . . . .        | 105-110 | 221-230 |
| Light oil . . . . .      | 210     | 410     |
| Carbolic oil . . . . .   | 240     | 464     |
| Heavy oil . . . . .      | 270     | 518     |
| Anthracene oil . . . . . | 270     | 518     |

*Coal-tar Pitch.*—When coal-tar is distilled it may be separated by fractional distillation into (1) Light oils, (2) Heavy oils and soft pitch, (3) Anthracene oils and hard pitch. (1) The *light oils* include

all substances volatile below 200° C., such as benzene, toluene and their higher homologues, some ethylene hydrocarbides (olefins), basic substances and phenols. The ethylenic hydrocarbides and basic substances are eliminated by treatment with concentrated sulphuric acid, and the phenols by washing with alkaline lyes. The oil is then redistilled, collecting only the products which distil between 80° and 120° C. This liquid—the commercial benzol—contains variable proportions of benzol, boiling at 80° C., and toluene, boiling at 110° C., together with xylenes and other hydrocarbides boiling above 110° C. It can, according to the use to which it is to be put, be used as it is or it may be again fractionally distilled (see "Solvents," vol. iii. of this treatise). (2) *Heavy oils*.—These distil between 200° and 300° C., and being rich in solid naphthalene solidify to a crystalline mass in cooling. The naphthalene is separated by filtration and pressure, and the heavy oils freed from naphthalene may be used in making disinfectants, or for the manufacture of phenol and carboic acid. (3) *Anthracene oils*.—The residue from the distillation of the heavy oils is known as soft pitch. It consists of a mixture of solid hydrocarbides, anthracene, phenanthrene, pyrene and chrysene, together with several substances the nature of which is but imperfectly understood. By redistilling this oil at a dull red heat anthracene oil, from which anthracene is abstracted, is obtained. (4) *Soft pitch*, softening at 40° C. and melting at 60° C., is the residue from the distillation of the heavy oils, and is obtained by stopping the distillation before the anthracene oils begin to come over, that is to say, when the specific gravity of the oil as it distils is about 1·090. This pitch when well boiled and thinned down with naphtha or light oil is the most serviceable for varnish-makers. Mixed with coal dust and pressed into briquettes it forms block fuel. *Hard pitch*, softening at 100° C. and melting at 160° to 200° C., is very insoluble, so much so that it is of but little or no service to the varnish-maker. Too brittle for use in the manufacture of briquettes, it has to be mixed with the oil from which the anthracene has been eliminated. It contains free carbon, due perhaps to coking going on in the still. Behrens obtained from pitch freed from all oils up to specific gravity 1·120, by successive digestions with benzene, carbon disulphide, boiling benzene and boiling alcohol, 23·54 per cent. of a black powder, quite similar to South Wales anthracite, of the following composition:—

|                    | A.        | B.        |
|--------------------|-----------|-----------|
|                    | Per cent. | Per cent. |
| Carbon . . . . .   | 90·836    | 91·921    |
| Hydrogen . . . . . | 3·058     | 3·157     |
| Ash . . . . .      | 0·398     | 0·872     |

Good hard pitch, according to Habet, consists of carbon, 75·32; hydrogen, 8·19; oxygen, 16·06; ash, 0·43. *Medium hard pitch*, as its name implies, is obtained by stopping the distillation between the gravities 1·090 and 1·120. *Soft pitch* may be kneaded between the teeth. *Medium pitch* is less easily masticated. *Hard pitch* crumbles to a powder under the teeth.



*Bone Pitch.*—This bears the same relation to bone tar from the animal charcoal retorts as coal-tar pitch does to coal-tar from the gas retorts. It is an excellent pitch, the chemistry of which is unknown. The practical man knows it to be very tricky in varnish-making, but it yields a superb black when once it is got into solution and kept there. The addition of rosin renders it more tractable.

*Stearine Pitch.*—In the redistillation of fatty acids to improve their colour at 271° C. (520° F.), it is impossible to distil over the whole of the contents of the still. A certain proportion of neutral fat, due to the previous incomplete saponification of the fatty acids, remains in the still, mixed with decomposition products in the form of tar. After allowing time for the still to cool down a little, this incompletely distilled product is blown out of the still into another still made of cast-iron, in which, by distillation at a higher temperature (300° C., 572° F.), an additional distillate of fatty acids is obtained. The residual pitch, on cooling and solidification, is a bright black brittle mass, known as stearine pitch, and is much used as an electric insulator, and in the making of black varnishes for coachmakers.

It will readily be seen that the single-distilled pitch is but little better than a mixture of tallow and tar. It contains 2 to 3 per cent. of unchanged fat, and is, of course, useless for varnish-making.

Donath examined a tarry mass of this nature, and found it to contain 21 per cent. of matters soluble in alcohol. The alcoholic solution exhibited a very acid reaction and was highly fluorescent. During the distillation of the sample it produced a considerable proportion of hydrocarbons with the viscosity of lubricating oils. Stas found 5 per cent. of hydrocarbons produced in the distillation of fatty acids, and Cahours and Demarcay isolated and examined these products, and obtained from them a series of substances almost identical with the hydrocarbons existing in American petroleum.

These hydrocarbons are of both saturated and unsaturated series, and by further decomposition, owing to the heat of distillation, give rise to dark-coloured products, partly soluble in ether. Amongst the other ingredients of stearine pitch are the residue of the fatty acids, some neutral fats (glycerides), and other fatty esters, and probably also the anhydrides of fatty acids. A characteristic of these pitches is the presence of neutral asphaltum compounds of dark colour, containing nitrogen. These are only partially soluble in ether, and the addition of alcohol to this solution causes a dark sticky mass to separate out. Stearine pitch contains also some mineral matter. In the ash of stearine pitch Donath found small quantities of iron and copper, probably obtained from the retorts in the form of metallic soaps. Under the name of stearine pitch is known also the residue from the free fatty acids obtained from wool-wash water. The grease from the wash water is treated with sulphuric acid, or the previously recovered calcium soap is decomposed with sulphuric acid. The fatty acids obtained in this way are extracted with benzene, and distilled with superheated steam, and there remains a dark brown, pitch-like

residue, which is also known as stearine pitch. For this substance Donath proposes the name of stearine-wool-pitch, to distinguish it from the other.

The ash in stearine-wool-pitch was found to be almost free from copper, containing, in addition to a little iron, a large amount of calcium sulphate. It has been observed in the distillation of fatty acids which have been imperfectly saponified that a deal of acrolein is produced (which is recognised by its effects on the eyes and the nostrils), in addition to the gaseous and liquid hydrocarbons. The latter products are supposed to be due to the decomposition of a portion of the fatty acids owing to the temperature being too great. Bouis, however, asserts that they are due to the decomposition of the tar or pitch itself in the still.

It is often necessary to be able to differentiate between stearine pitch and wool pitch on the one hand, and petroleum pitch (the residue from the distillation of petroleum) on the other. They may generally be identified by the fact that soft and medium hard pitch contains a considerable proportion of saponifiable matter; moreover, stearine pitch has a characteristic smell of its own. Hard stearine pitch contains a smaller proportion of unsaponifiable matter. Holde and Marcusson have obtained the following results. Soft and medium-hard stearine pitch: acid value, from 9.2 to 22.5; saponification value, from 11.5 to 34.0. Hard stearine pitch (six samples): acid value, from 0.2 to 4.0; saponification value, from 2.2 to 7.2. Very viscous, soft and hard petroleum residues: acid value, from 0.1 to 1.2; saponification value, from 1.1 to 2.6.

By heating stearine pitch cautiously in a porcelain or platinum crucible or in a test tube, it may be distinguished by the smell of acrolein which it emits. Soft stearine pitch, although attractively elastic, is not a desirable material for varnish-making. Moreover, when liquid substances other than linseed oil are used to dissolve pitch, they run and soften on the application of the second coat, and cause endless trouble if the article coated comes in contact with the substance used to dissolve them, or an allied substance. In these days of linseed oil substitutes, there is no need to go far for a paint remover, or even, in some cases, a varnish remover.

Other pitches are formed as a bye-product in refining cotton-seed oil, by which stearine and stearine pitch are obtained. Stearine pitch is sometimes used in the manufacture of tarpaulins and waggon covers, and in certain compounds which are made for the insulation of electric wires. It is better than coal-tar pitch for this purpose, as it does not appear to be so liable to crack. Stearine and coal-tar pitches are both used in the preparation of black varnishes, for the manufacture of roofing felt, etc. For this purpose a liquid such as creosote oil is heated up in a boiler, and sufficient pitch is added and stirred up until dissolved in the oil. Another use to which these materials are put is the preparation of waterproof packing paper, which is brown paper coated on one side with pitch. A patent pack-

ing paper has also a large-meshed cotton fabric applied over the pitch to obviate stickiness.

#### GUTTA-PERCHA.<sup>1</sup>

*Origin.*—Gutta-percha is the product resulting from the drying of the sap of the *Isonandra Gutta* (Hooker), a tree indigenous to the Malay Peninsula. *Properties.*—Gutta-percha is a greyish-white substance, with great suppleness but little elasticity. It melts at 48° C. It is ductile at 50°, pasty and malleable at 100°, and fusible at 130°. Left for a long time in contact with the air, it alters and becomes brittle. *Composition.*—According to Payen it contains three proximate principles, which he named gutta, albane and fluavile. *Solubility.*—It is insoluble in water; alcohol only dissolves 15 to 22 per cent. It partially dissolves in the hot in spirits of turpentine, and shale naphtha and in fatty oils. It also dissolves fairly well in benzene, and is completely soluble in bisulphide of carbon and chloroform, yielding after filtration perfectly limpid and colourless solutions. It resists the action of alkalies and most acids. It contains a resinous principle like common rosin which is extracted on the large scale to harden the gutta-percha. This rosin could very well be used as a substitute for common rosin.

#### INDIA-RUBBER, OR CAOUTCHOUC.<sup>1</sup>

*Origin.*—India-rubber is the dried milky juice which runs from a great number of South American, African and Indian plants such as the *Hevea Brasiliensis*, the *Ficus Elastica L.*, the *Castilloa Elastica Cav.*, etc. *Commercial varieties.*—These are distinguished according to the names of the country from which they have been imported. (1) *Brazilian rubber.*—Para (the most highly esteemed), Maranhão, Ceará, Bahia, Pernambuco. (2) *Central American rubber.*—Panama, Guayaquil, Carthagena, Central America. (3) *African rubber.*—Gaboon, Sierra Leone, Liberia, Mozambique, Madagascar, Nossi-Bé. (4) *Asiatic rubber.*—Assam, Rangoon, Singapore, Borneo, Java, Sumatra. *Properties.*—India-rubber is soft, flexible and almost colourless in thin sheets; it possesses a remarkable elasticity, but it hardens with cold. It melts at 235°. *Composition.*—India-rubber is a hydrocarbon with a composition corresponding to the formula  $(C_5H_8)_n$ , it moreover contains small quantities of fatty matters, nitrogenous substances, sulphur and chlorine. *Solubility.*—India-rubber is insoluble in water and alcohol; it is soluble—or rather swells whilst presenting the appearance of a real solution—in ether bisulphide of carbon, coal-tar naphtha, petroleum spirit and essential oils. Heavy coal-tar oils dissolve about 5 per cent. of their weight,

<sup>1</sup> See *India-rubber and Gutta-percha* (Scott, Greenwood & Son). As specimens of gutta in museums have themselves to be protected from decay by a varnish, it scarcely seems wise to introduce it into varnish.

whilst the light naphthas dissolve about 30 per cent. The best solvent for rubber is a mixture of 100 parts of bisulphide of carbon and 5 parts of absolute alcohol which yields a perfectly limpid solution. It is necessary to remark that if the evaporation of the solvent be slow, the rubber yields a tacky, pitchy coat. India-rubber withstands the action of alkalies and dilute acids. For a description of india-rubber substitutes see vol. i. of this treatise. When rubber is coated with an oil varnish the rubber soon decays. That fact seems to point to its being dangerous to introduce it into varnish.

PARAFFIN WAX. *Melting-point, 58° C.*

Paraffin is a white substance, brilliant, solid, soft, inert, inodorous and insipid. It dissolves in  $28\frac{1}{2}$  parts of boiling alcohol, from which it separates in beautiful pearly lamellæ on cooling. It dissolves also in petroleum and shale naphtha, spirits of turpentine and fixed oils. It is obtained by distilling crude petroleum and shale oil. It concentrates in the heavy oil distillates, from which it is separated by a process of refrigeration, sweating and consecutive refining by acid and alkali. Paraffin is sometimes used to diminish the brittleness of some varnishes. It is likewise used as an encaustic, and finds a special use in mural decoration by artists to protect and preserve delicate tints without injuring their purity of tone. It has the disadvantage of becoming plastic and liable to bend considerably below its melting-point, but its indifference to acids and alkalies recommends it for many purposes; a minor application of this property being to coat the labels used on chemical laboratory reagent bottles so as to preserve them from acid fumes. It consists of a mixture of solid hydrocarbides of the marsh gas or  $C_nH_{2n} + 2$  series to which it gives its name. *Ozokerit* (*Earthwax* or *Ceresin*) is a naturally occurring crude paraffin wax of high melting-point. Its colour is generally black from bituminous impurities, but it may be refined into yellow and white ceresin.

*N.B.*—Both paraffin wax and ceresin if present in a previous coat of varnish or waterproofing composition are dissolved by the next, so that only one coat can be applied, and the application of even one coat is difficult in hot weather, when the varnish into which they enter is resolved into a sort of grease which runs in streams when the surface is a little more warm than when applied. They are treacherous substances to work with especially in waterproofing compositions, although they have a distinct use when used discriminately. Paraffin finds a legitimate use in varnishes for temporarily coating glass for engraving purposes. Paraffin, 40 ounces; yellow wax, 40 ounces; vaseline, 20 ounces. (See also under "Spirit Varnish Manufacture," vol. iii. of this treatise.)

## CHAPTER IV.

### COPAL.

*Definition—Geographical origin and distribution—Botanical source—Composition and properties of the different varieties.*

THE term "copal" would appear to have been first used in France. If "copal" be originally a Mexican word, yet it would be erroneous to suppose as formerly that commercial copal comes from Mexico. When the Mexican source of copal was found to be a myth, attempts were then made to locate the geographical origin in India. Later on it became known that the resin known in Britain under the name of East Indian Animé, Oriental Animé, Bombay Copal, Calcutta Copal, was only imported into India from the West Coast of Africa and the adjacent islands of Zanzibar and Madagascar. East Indian animé and copal were, in this way, found to be identical. The word "animé" is derived from *animus*, a term used by J. Rodrigues de Castello-Branco, celebrated under the name of *Amatus Lusitanus*, to designate a resin from the East Coast of Africa. From time immemorial Arab trading ships plied all along that coast and the resin was exported from Arab ports to India. The Arabs knew the route to Madagascar in very ancient times, and were the trading pioneers who spread a knowledge of copal and its function in oil varnish-making all over Europe. But the term "copal," originally confined to the resin which the Arabs carried to Bombay and Calcutta, there to be dispersed over the markets of the world (p. 54), soon became applied to other resins, so that at the present day it has become a generic term for any and all resins, amber excepted, fossil and recent, suitable for oil varnish-making. The subject is important enough to warrant some space being devoted to the elucidation of this important point.

*Copal: Definition.*—Commercially the term "copal" is not, nowadays, specifically restricted or solely applied to East African copal, but is used in a comprehensive way to group as it were under one commercial genus or species several widely distributed and more or less well or ill-defined resins having one main if not sole character in common, that of being capable of being used in the manufacture of oil varnishes. Putting amber to one side, true, *i.e.* Zanzibar, copal was the first resin used in the manufacture of oil varnishes; hence arose the custom of terming each new resin capable of being used in oil varnish manufacture as it came on the European varnish resin market "copal," distinguishing it from others on the market by prefixing its port of shipment or some other sufficiently indicative term. We have thus

in our own day in turn seen Kauri resin from a coniferous tree, the Kauri or Cowrie and Manilla resin (named after the style of Manilla hemp from its port of shipment) from a more than dubious botanical source both termed "copal," with no other justification than their property of being capable of being used as a constituent of oil varnish, and a *prima facie* greater or less outward resemblance to true copal. A copal may, therefore, be comprehensively defined as a hard resin of high melting-point capable of being used in oil varnish manufacture, with the proviso that it is not capable of being completely dissolved in either hot or cold linseed oil or the usual resin solvents until some considerable if variable percentage of it has been destructively distilled off, and the distillate either collected apart in a suitable receiver or dissipated into the atmosphere. Commercial copals thus yield by dry distillation (1) a volatile oil and (2) a resinous residuum soluble in all varnish solvents, including linseed oil, its solution in which may be thinned down with spirits of turpentine to any desired consistency or degree of attenuation according to the purpose to which it is to be applied. "*Copal*" means therefore commercially nothing more nor less than an oil-varnish resin. As a matter of fact, all oil-varnish resins are termed "copal". If dammar, mastic and sandarac were oil-varnish resins they also would possibly be termed copals, and that notwithstanding their quite distinct botanical origin. The commercial copals may be classified according to their hardness into (1) hard copals, (2) medium hard copals, and (3) soft copals.

(1) The *hard copal* class include the true copals of the East Coast of Africa, typical of which is Zanzibar copal (also termed East Indian animé, Bombay copal, Calcutta copal). Other varieties of East African true copal are Mozambique copal and Madagascar copal. (2) The *medium* or *semihard copals* comprise West African copals, Accra, Ashanti (Gold Coast), Angola, Benguela, Benin, Congo (Gaboon), Cameroon and Sierra Leone copals. (The pebble copal or pebble animé of Sierra Leone ranks next in hardness to Zanzibar copal and should possibly rank among the hard copals.) (3) *Soft copals* (*copal tendre*), American animé, Kauri copal, Manilla copal, Borneo copal. Of these three classes or groups only the copals ranked in class (1), derived from species of *Trachylobium*, are capable of being regarded scientifically as true copals. Those in classes (2) and (3) include the resins commercially termed copal, from their similarity in composition and behaviour under the action of heat and solvents, and more especially because they are used for the same purposes as the true copals, in the manufacture of "copal" oil varnishes, and that notwithstanding the fact that they differ from the true copals not only in botanical and geographical origin, but in hardness, solubility, chemical composition, and, above all, in the nature of the varnish which they yield, which is decidedly inferior in every way to that from the true copals.

*General Properties of Copals.*—Copals are obtained in round tears, nodules, or flat pieces, of hardness often varying inversely

with the size, that is, the smaller the pieces the harder the copal; the larger the lumps the softer the copal; hard copals are rarely so big as a man's fist, but lumps of soft copal may sometimes weigh 60-120 lb. and upwards. *Surface marks*: *Goose skin*.—There is almost always a peculiar more or less thick weather-beaten oxidised crust on the surface of copal which, varying in colour, may be removed by scraping with a knife or by washing with alkaline lyes. On its removal certain copals are smooth; others have mammillary asperities, of an irregular polygonal form. Some are striated and pitted all over the surface. *Colour* varies, more so in soft copals; few, excepting South African copal, are transparent. *Fracture* is generally conchoidal. *Lustre* is resinous, more so in soft copal. In some hard sorts the fracture is flat and lustre dull, whilst the fracture of the best Zanzibar shows dull and lustrous alternations. Exposure to air deadens lustre of soft but not of hard copals. *Smell and taste*.—Zanzibar copal is insipid and inodorous. Others have a more or less agreeable aromatic smell, varying with each kind. Borneo, Manilla and Kauri are characteristically fragrant. *Friability and plasticity*.—Between the teeth copal breaks to a powder, which does not re-agglutinate. *Hardness* is the most important property of copals. Andès and Bottler classify them in order of hardness, starting with the hardest variety at the top and finishing with the softest variety at the bottom.

TABLE VIII.—SHOWING ANDÈS' SCALE OF HARDNESS (COPAL).

| No. | Copal.         | No. | Copal.            | No. | Copal.         |
|-----|----------------|-----|-------------------|-----|----------------|
| 1   | Zanzibar       | 8   | Globular or glass | 15  | Angola (white) |
| 2   | Mozambique     | 9   | Akra              | 16  | Kauri          |
| 3   | Madagascar     | 10  | Benin             | 17  | Manilla        |
| 4   | Sierra Leone   | 11  | Loango            | 18  | Borneo         |
| 5   | Angola (red)   | 12  | Gaboon            | 19  | Singapore      |
| 6   | Benguela       | 13  | Congo             | 20  | South American |
| 7   | Bastard Angola | 14  | Sierra Leone      | 21  | Cochin China   |

*Bottler's scale of hardness* differs slightly from that of Andès. *Hard*: (1) Zanzibar; (2) Mozambique; (3) Red Angola; (4) Sierra Leone pebble; (5) Sierra Leone fossil; (6) Yellow Benguela; (7) White Benguela; (8) Cameroon; (9) Congo. *Medium Hard*: (10) Manilla; (11) White Angola; (12) Kauri; (13) Sierra Leone (raw); (14) Brazil (South American).

Rock salt, No. 2 of Moh's scale, scratches all copals but Zanzibar, Red Angola and Sierra Leone (fossil) only faintly (Bottler). Zanzibar and Mozambique copals scratch rock salt, but are scratched by copper sulphate (Wiesner). Manilla, Congo, Sierra Leone, but not other copals, split when a needle-point is directed against any one of their smooth faces (Bottler). All are scratched by calc spar, No. 3 of Moh's scale, but all, fetchy sec excepted, scratch talc, No. 1 of

Moh's scale. *Density*.—Owing to air cavities, hard copals are lighter than soft, *i.e.*, gravity is in inverse proportion to value. By pulverising the copal to expel enclosed air, their density increases from 1.068 to 1.082, and from 1.069 to 1.111. The increase is greater with soft copals, some of which become heavier than hard, *e.g.*, Zanzibar copal, 1.0621, and White Angola, 1.035, but Meich and Stinghl give 1.062 for White Angola.

TABLE IX.—SHOWING DENSITY OF COPALS PRIOR TO AND AFTER BREAKING UP OF AIR CAVITIES (BOTTLER).

| Variety.             | A.       | B.     | Variety.                    | A.    | B.     |
|----------------------|----------|--------|-----------------------------|-------|--------|
| South American . . . | 1.069-70 | 1.131  | Sierra Leone (pebble) . . . | 1.067 | ...    |
| Brazil . . . . .     | 1.069    | 1.083  | Yellow Angola . . . . .     | 1.065 | ...    |
| Manilla . . . . .    | 1.069    | 1.128  | Cameroon . . . . .          | 1.065 | 1.080  |
| Lindi . . . . .      | 1.0685   | 1.0695 | Sierra Leone . . . . .      | 1.064 | ...    |
| Red Angola . . . . . | 1.068    | 1.082  | Zanzibar . . . . .          | 1.062 | 1.0636 |

A, Density before expulsion of air; B, Density after extraction.

*Fusibility*.—If appearance and hardness of different sorts of copals vary much, the melting-point if variable with each sort is very high in all, *viz.*, 180-340° C. (356-644° F.). But Bottler gives them as 90-315° C. (194-599° F.), as in the following table:—

TABLE X.—SHOWING IN DESCENDING ORDER IN °C. AND °F. THE MELTING-POINT OF THE DIFFERENT VARIETIES OF COPALS ACCORDING TO BOTTLER.<sup>1</sup>

| Variety.               | Melting-point. |           | Variety                   | Melting-point. |         |
|------------------------|----------------|-----------|---------------------------|----------------|---------|
|                        | °C.            | °F.       |                           | °C.            | °F.     |
| Red Angola . . . . .   | 305            | 581       | Congo . . . . .           | 180            | 356     |
| Zanzibar . . . . .     | 259-265        | 466-2-509 | White Benguela . . . . .  | 175            | 347     |
| Lindi . . . . .        | 246            | 474.8     | Yellow Benguela . . . . . | 170            | 338     |
| White Angola . . . . . | 245            | 473       | Kauri . . . . .           | 140-170        | 284-338 |
| Sierra Leone (pebble)  | 220            | 428       | Manilla . . . . .         | 135            | 275     |
| Sierra Leone . . . . . | 185            | 365       |                           |                |         |

Heated in a candle flame copal emits a smoky flame and melts in drops—distinction from amber.

*Solubility of Copal*.—Bottler classifies copals in the order of solubility as shown in the following table, beginning with the most intractable:—

<sup>1</sup> In the first edition of this treatise the melting-point as given by Livache (also quoting Bottler as authority) of these resins, Kauri and White Angola excepted, was given as 10° C. higher than in the above table. The new figures are from the second edition of Tschirsch.



TABLE XI.—SHOWING IN ASCENDING ORDER THE SOLUBILITY OF DIFFERENT VARIETIES OF COPAL.

| No. | Copal.       | No. | Copal.       |
|-----|--------------|-----|--------------|
| 1   | Zanzibar     | 7   | Congo        |
| 2   | Lindi        | 8   | Brazil       |
| 3   | Cameroon     | 9   | Kauri        |
| 4   | Pebble       | 10  | Manilla      |
| 5   | White Angola | 11  | White Angola |
| 6   | Sierra Leone |     |              |

Different sorts and different samples and deliveries of the same sort vary in solubility; besides, one operator gets different results from another, one observer has more natural aptitude for the work of tackling a resin in the right way to effect solution than another. Vague statements as to the solubility of "copal" in this or that menstruum, unqualified by the name of the variety, are valueless, and even when the variety is given, too little care by far is taken to ensure authenticity. To obtain authentic samples of coal one must personally go down the pit and see the samples mined out of the earth if it be desired to give authentic analyses of such samples to the world. The samples of resins are so little authenticated that they are taken after the style of an expert writer on coal so ill-advised as to base his analyses on odd samples taken from, say, a railway waggon or a coal merchant's bin. All data anent resins must therefore be carefully scrutinised. The solubility of copal is said to depend on the resins into which it can be resolved by *fractional solution*, such resins behaving differently under action of solvents. Unverdorben thus separated South African copal into five different resins: A, B, C, D, E. A melts at 100° C. (212° F.) and dissolves freely in 72 per cent. alcohol; B does not melt at 100° C. (212° F.), is insoluble in alcohol, spirits of turpentine, fixed oils, soluble in absolute alcohol, ether; C is separated from the residue insoluble in absolute alcohol by saponification with alcoholic potash and decomposition by sulphuric acid. It merely froths at 350° C. (662° F.), is insoluble in absolute alcohol, ether, spirits of turpentine and in ether and cajeput oil. The resin D, extracted from the unsaponifiable residue by exhaustion with alcohol and decomposition by hydrochloric acid, undergoes no real fusion above 300° C. (572° F.); it is naturally insoluble in absolute alcohol, ether and spirits of turpentine, and neither combines with acids nor alkalies. Different sorts alter towards solvents according to which resin predominates. Age alters copal. Air acts on the resin as it exudes from the tree, a fact confirmed by resins D and E covered by alcohol, or alcohol and ether, absorbing oxygen and changing to resins A, B and C. E resisting all the preceding treatment is a compact infusible resin, insoluble in alcohol. This fractional separation of resins by solvents for purely analytical purposes is not capable of being made use of for

manufacturing purposes with present plant. It is, however, a typical illustration of the analytical methods of the older chemists in their examination of resins, a style of analysis which Tschirsch and his coadjutors (pp. 20, 38, etc.) have recently revived in a form modified and controlled by more modern scientific processes. But the constitution of different samples of the same sort of copal may vary within wide limits.

*Solubility of Copals generally.* (1) In *Ether*.—Ether converts copal into a jelly which dissolves on the addition of hot alcohol. Manilla after crushing and long air exposure or slight torrefaction dissolves. (2) In *Methylated Spirit*.—Dissolves 40 per cent. of Sierra Leone, but if it softens it, it scarcely if at all dissolves Zanzibar. The viscous grey residue from treating Sierra Leone copal with alcohol is dissolved by adding a little spirits of turpentine. Some sorts of Manilla dissolve after being treated as in (1) ether. Oxalic acid aids solution of Kauri in methylated spirit. (3) *Camphorated Alcohol*, *Camphorated "Turps,"* etc., dissolve several varieties of copal. (4) *Spirits of Turpentine* has no immediate solvent action, but owing probably to oxidation after a long time (far too long to be of any practical use) solution is complete. All copals are, however, more or less dissolved by artificially oxidised spirits of turpentine, thickened turpentine, Sierra Leone completely so; others dissolving partially, dissolve completely on repeated treatment. (5) *Amyl Acetate*.—A good solvent for soft copals but marred by its smell. (6) *Cajeput, Rosemary and Lavender Oils*.—Cajeput oil, possibly owing to its containing terpineol acetate, seems to possess very marked solvent properties for copal, especially Angola, which it is said to dissolve completely. Oil of rosemary and lavender oil act similarly and possibly owing to similar causes. No doubt the formation of compounds allied to camphor is the cause of the more powerful solvent action of oxidised turpentine. (7) *Amylic Alcohol* (rectified fusel oil) is a very active solvent for Kauri and Manilla (but scarcely attacks hard copals). On heating the copal swells and dissolves completely; the clear, almost colourless, solution dries to a very transparent lustrous varnish. Absolute alcohol precipitates copal from its amylic alcohol solution, but amylic alcohol and chloral reclarify it. The toxic effects of amylic alcohol and its permanently persistent smell mar its efficacy as a solvent. It is not the irritating smell of the varnish alone but that of the article on which it is applied, which retains it all its life—say, a straw hat in a warm room will start every one near a-coughing many months after application. (8) *Nitric Ether* completely dissolves Manilla. The resin first softens, then gives a green solution passing to brown, which is thinned to any desired consistency with alcohol. (9) *Aniline* acts at once on all copals, completely dissolving soft sorts, but the smell and dark solution prevent its use. (10) *Alkaline Lyes* attack all copals; soft sorts are easily saponified at a low heat, hard sorts are strongly attacked, Angola being completely saponified.

*Summary.*—The solubility of copal varies perceptibly with its oxygen content. If pulverised under water and exposed to air it

dissolves the easier the more oxygen absorbed. If coarsely crushed results are negative. Andès grinds copal with inert solids, e.g., stibnite and fluorspar, in ratio of 1 to 7. A finer powder is thus got and solubility is greatly increased; the air gets better at the more extended surface, and isolation of the particles of copal not only prevents agglutination but affords more extended surface for action of solvent.

*Adulteration.*—Poor soft mixed with good hard sorts detected by lowering of the melting-point. Good hard sorts melt between 275-315° C. (527-599° F.), some say 340-360° C. (644-680° F.).

*Buying Precautions.*—Avoid dust which gives bad results. Choose well-known brands with equal-sized uniformly coloured lumps of Zanzibar, Angola and Benguela, especially for washing, as large as obtainable and as hard as big. West African (Sierra Leone, Angola, Congo) are best bought washed; unwashed contains much dust and rubbish. Many sorts of Borneo and Manilla are on the market. Dark brown sorts with dull fracture yield soft stringy varnishes which do not bind well. Copal dust may contain much rosin.

*Varieties of Copal. Group I.: East African.*—This group includes the hard fossil Zanzibar copal (animé), recent or raw Zanzibar copal, Mozambique copal, and Madagascar copal. Zanzibar copal, known also from former ports of shipment to this country (p. 30) as East Indian animé, Bombay copal, Calcutta copal, is found in the district in and around Zanzibar. There are two sorts, (1) *fossil* or ripe (*sandarusi*), and (2) *recent* or raw (*sandarusi niti*), commonly called *chakazi*, hence corrupted to *jackass*. It is generally acknowledged that the tree known to botanists as *Trachylobium Hornemannianum* (Fig. 5) is that from which the now fossil Zanzibar copal exuded in bygone ages, and flowing to the ground, became embedded therein to be afterwards disinterred after having undergone the process known as fossilisation. This tree grows in abundance in Zanzibar at the present day. Although Hayne classifies this tree as a distinct species, under the title of *Trachylobium Hornemannianum*, a synonym of the *Hymenœa Hornemanniana*, D. Dietr, it is possibly only a variety of *H. Verrucosa* of Madagascar. The only important difference, but a non-specific one, according to Gilg, lies in the structure of the two corollas. In the *H. Verrucosa* of Madagascar the corolla (Fig. 7) consists of five almost equal, unguiculated petals, whilst the copal-tree of Zanzibar (Fig. 5) has a five-petalled corolla, the three anterior petals of which are almost equal and unguiculated, the two posterior being squamiform and rudimentary. As the two types of corolla have never been found on the same tree, possibly, therefore, *H. Verrucosa* is confined to Madagascar, whilst *H. Mossambicense* is indigenous to both Madagascar and Africa. In any case the Zanzibar copal-tree of the present day, somewhat resembling a spreading ash-tree and called by the Arabs *Shajar-el-sandarus*, still lingers, preferably in the vicinity of running water on the mainland adjacent to the island of Zanzibar, often attaining a height of 20 to 25 feet to the first branch and 3 to 5 feet in girth. It frequents the coast, striking inland beyond the

coast ridge, where it flourishes more abundantly. It dwindles out as it nears the limestone, and as the fossil resin is far more abundant than the present comparatively rare trees justify, it would seem, unfortunately, possibly from changed climatic conditions, to be dying out. Acclimatisation trials have been made in India and Australia. The resin is either collected on the tree or is found unchanged in the loose soil. Like some resiniferous coniferous pines, etc., wherever the bark is punctured resin exudes. Every organ is saturated with resin, even the fruit legumes are dotted with excrescences of bright transparent resin enclosed in a thin cuticle. It is, however, naturally



FIG. 6.—Zanzibar Copal-tree (*Trachylobium Hornemannianum*). Flowering branch and fruit.

from the trunk and large branches that the most considerable mass of resin exudes. The recent or raw resin is collected either by picking it from the tree, or it is dug out of the earth as on Zanzibar island, where it has penetrated to a shallow depth but undergone no change. The copal collected on Zanzibar island consists entirely of *chakazi*. Innumerable insects, especially ants, bore into the copal-tree; the ravages of these insects are such that Captain Elton asserts that when the heart of the tree is undermined the tree exudes resin in quantity, seeming thereby to make an effort to stop its destruction. Raw Zanzibar copal *chakazi*, soft, has a smoky look and is shipped to Bombay, where it is made into low-class varnish, and to China, where

the Chinese, they say, know how to utilise it by secret processes. Perrot recently made an expedition to Lake Lutamba, and reports that there the copal-tree is very common. Between Mikindani and Mitingi trees stand on the water's edge. Behind Mikindani much copal is dug, most of the diggings being on the tablelands of Muera and Makonde. This depends upon the nature of the soil, as fossil copal is only formed in loose, sandy ground. But all the kinds of copal which get into commerce from this district come from one and the same sort of tree. A giant copal-tree, the branches spreading over a space 100 feet in diameter, and covered with thousands of fruits, was seen on a small tableland between the creeks Ndumbwe and Mbuo, tributaries of the Sudi. Unfortunately, the natives destroy many copal-trees, as the easily detached bark makes splendid cages for hens and pigeons. Trees ringed for this purpose naturally soon succumb. Thousands of these valuable trees are also destroyed in colossal forest fires, started, according to the *mulin* of the village on Lutamba island, by the natives for hunting purposes. All the copal dug up is found near the surface, so that there is none out of the reach of the natives to reward white exploitation. The aborigines of various tribes only know of one copal-tree, which they call *mkumbi*.

Tschirsch and Stephan examined Zanzibar copal, and from the results obtained the sample was very evidently one of recent or raw Zanzibar copal. It left 0.12 per cent. of ash, and, when finely powdered and left for a long time in presence of an excess of various solvents, it ceded thereto the following amount of resin per cent. respectively: Acetone and ether, 34; benzol, acetic acid, chloroform and toluol, 30; amyl alcohol, 40; petroleum ether and carbon disulphide, 10; ether-alcohol, 50; chloroform-alcohol, 60; benzol-alcohol, 86. The resin completely dissolved in alcohol after long digestion. After eight weeks' digestion only 0.42 per cent. of impurities remained. When kept at 80° C. for some time it increased in weight, and became readily soluble in alcohol. Zanzibar copal, which contains no sulphur, nor nitrogen, distilled with water or potash, yields a sort of camphorous distillate, which, fractionated in a stream of carbonic acid, yields a fraction boiling at 163-165° C. of the formula  $C_{12}H_{20}O$ . The dry distillation of the resin yielded an oil containing butyric acid which on treatment in ethereal solution with metallic sodium yielded four fractions. The first colourless fraction at 100° C. was only a small drop, the second 150-151° C. was yellowish and very refractive, and contained a hydrocarbide  $C_7H_{12}$ . The third fraction, 199-201° C., with the fourth, 225-227° C., contained a body of the formula  $C_{28}H_{46}O$ . Schieblier's copalic acid was not found. The copal was dissolved in alcohol to prepare the pure resin. It is not easily dissolved by heating, nor by aid of the reflux condenser, nor by Soxhlet's extractor. Better results were obtained by digesting the powdered resin with alcohol, when the greater bulk dissolved in a few days. The solution was freed from the bulk of the alcohol by distilling and the residue taken up by acidu-

lated water; the pure resin remains and the bitter principle dissolves. The acid solution is precipitated by lead, the lead removed by sulphuretted hydrogen, and shaken with pure ether. It could not be obtained in a form pure enough for analysis. This is the case with all bitter principles not of a glucoside nature. The pure resin can thus be freed from bitter principle. It melts at about  $112^{\circ}$  C. Zanzibar copal begins to soften at  $120^{\circ}$  C. and melts at  $140^{\circ}$  C. The pure resin dissolves better than the unpurified resin. Acetone dissolves, 60; toluol and benzol, 52; ether, 90; chloroform, 80; petroleum ether 26 per cent. It is completely soluble in amylic-alcohol, phenol, aniline, ether-benzol, chloroform-alcohol. The solution in hot alcohol becomes cloudy on cooling. In the cold, dilute potash dissolves little, concentrated *nil*. The pure resin dissolves on prolonged boiling in caustic potash or potassium carbonate. This solution is quantitatively precipitated ("salted" out) on addition of strong potash. The alcoholic solution of the pure resin reacts acid; 0.1 of pure resin requires for titration 1.7 c.c. *n*/10 alkali. Aldehyde was not detected in the pure resin. Saponification with caustic potash yielded no result. It seems the pure resin contains no ester. The resin acid by steady boiling (10 weeks) with caustic potash lye changed its composition. When the alkaline solution was acidulated with hydrochloric acid a substance was obtained soluble in dilute alcohol and toluol. The acid reacting alcoholic solution gave a precipitate with metallic salts, and from the lead acetate precipitate an acid was got with the melting-point  $153^{\circ}$  C., of which on titration 0.1 gramme required 3.7 c.c. *n*/10 potash. The analyses of this substance gave the following results: Found mean of two analyses, C=71.20, H=9.23. Calculated for  $C_5H_8O$ , C=71.43, H=9.52 per cent. Oxidation therefore occurred during the treatment with potash. Alcoholic potash gave similar results. Saponification could not be effected by sulphuric acid. Further investigations as to the composition of copal resin were carried out. The resin was dissolved in ether, alcohol added and the solution agitated with 1 per cent. potassium hydrate or 3 per cent. potassium carbonate. In both solutions the resene remains dissolved in the supernatant ether when agitation ceases to extract anything further.

Hydrochloric acid precipitates from the weak alkaline lye which has been agitated with the ethereal solution of the copal a copious precipitate of resin acids which behaves to solvents in the same way as that extracted from the pure resin. Only the hot alcoholic solution remained clear on cooling, and the body dissolved completely in glacial acetic acid. In dilute alkalis the resin acids were completely dissolved but separated as potassium salts by strong potash. A separation in this way did not succeed. Better results were obtained by an alcoholic solution of lead acetate. One portion is precipitated, another remains in solution. The precipitate is the lead salt of trachyloic acid. The lead salt of isotrachyloic acid remains in solution. The precipitated lead salt of trachyloic acid is suspended in alcohol and treated with

sulphuric acid and the alcoholic resin acid solution treated with water. Trachylolic acid prepared in this way is colourless and dissolves readily in absolute alcohol, acetic acid, phenol, amyl alcohol and aniline and only partially in toluol, chloroform, ether, acetone, carbon disulphide and petroleum ether. The melting-point is about  $165^{\circ}\text{C}$ ., crystallised about  $168^{\circ}\text{C}$ . It is optically inactive, and crystallises with difficulty, and best from an alcoholic solution by passing hydrochloric acid gas and from acetic acid in the form of sphæro crystals; melts at  $152^{\circ}$ . Elementary analysis gave the following: Found, dried over sulphuric acid, mean of three analyses,  $\text{C} = 75.5$ ,  $\text{H} = 10.22$ ; dried at  $80^{\circ}\text{C}$ ., mean of two analyses,  $\text{C} = 75.65$ ,  $\text{H} = 10.10$ . Sphæro crystals at  $80^{\circ}\text{C}$ .,  $\text{C} = 75.88$ ,  $\text{H} = 10.25$ . Calculated for  $\text{C}_{56}\text{H}_{88}\text{O}_8$ ,  $\text{C} = 75.68$ ,  $\text{H} = 9.91$  per cent. The potassium salt of trachylolic acid is prepared by adding potassium carbonate to the alcoholic solution of the acid, evaporating to a dry powder and extracting the residue with alcohol. The potassium salt gave the following result: Found  $\text{K} = 7.79$ ,  $7.86$ . Calculated for  $\text{C}_{56}\text{H}_{88}\text{K}_2\text{O}_8$ ,  $\text{K} = 8.09$  per cent. Titration with  $n/10$  potash (solution in excess of alkali and back titration). Found mean of three analyses,  $\text{K} = 7.8$ . The copper salt is prepared by the precipitation of the alcoholic solution of the potassium salt by an alcoholic solution of copper chloride and gave the following result: Found  $\text{Cu} = 6.75$ ,  $6.26$ . Calculated for  $\text{C}_{56}\text{H}_{88}\text{CuO}_8$ ,  $6.63$  per cent. An iron salt was prepared by the addition of iron chloride to the solution of the potassium salt. A basic salt is produced of the possible formula  $2[(\text{C}_{54}\text{H}_{86}\text{O}_4 < \frac{\text{COO}}{\text{COO}})_3\text{Fe}_2] \cdot \text{Fe}(\text{OH})_6$ . Found  $\text{Fe} = 6.16$ ,  $6.35$ . Calculated  $\text{Fe} = 4.914$  per cent. Methoxyl was not detected in trachylolic acid. Acetylated with acetic anhydride trachylolic acid leaves an acetyl derivative which on the addition of free acid is soluble in chloroform, acetone, ether, toluol and benzol, and only partially soluble in carbon disulphide and alcohol. It yields the following results on analysis: Found mean of two analyses,  $\text{C} = 75.02$ ,  $\text{H} = 9.24$ . Calculated for  $\text{C}_{56}\text{H}_{87}\text{O}_8 \cdot \text{CH}_3\text{CO}$ ,  $\text{C} = 74.84$ ,  $\text{H} = 9.68$ . On benzylation a benzyl derivative was obtained readily soluble in amyl alcohol and freely in chloroform and only partially so in other solvents. It gave the following results: Found mean of two analyses,  $\text{C} = 76.40$ ,  $\text{H} = 9.55$ . Calculated for  $\text{C}_{56}\text{H}_{87}\text{O}_8 \cdot \text{C}_6\text{H}_5\text{CO}$ ,  $\text{C} = 76.21$ ,  $\text{H} = 9.27$  per cent. A monoacetyl and a monobenzyl derivative were prepared. So there is at least one hydroxyl group in the molecule. It contains two atoms of hydrogen replaceable by metals, so trachylolic acid may be written  $\text{C}_{54}\text{H}_{85}\text{O}_3\text{OH}(\text{COOH})_2$ . Trachylolic acid is sulphonated by concentrated sulphuric acid. Concentrated nitric acid gives a nitrogenous nitro product in addition to picric acid and oxalic acid. Fused potash yields besides oxalic acid a body which gives the reactions of salicylic acid. Dry distillation with zinc dust yields besides acetic acid a liquid that was treated with sodium and fractionated. The first fraction (at about  $100^{\circ}\text{C}$ .) was in the form of a few drops of an aromatic fluid which nitrated yielded no nitro-benzol. Fractions two ( $170\text{--}200^{\circ}\text{C}$ .) and three ( $200\text{--}240^{\circ}\text{C}$ .) were

yellow. Fraction four (240-250° C.) was green and constituted the bulk. It was refractionated and resolved into a fraction boiling between 245 and 247° C., containing C=87.56, 87.52, and H=11.03, 11.24 per cent.

This fraction, isolated from the product of the dry distillation, is found to consist of the previously mentioned hydrocarbide  $C_7H_{12}$ . It has already been mentioned that another acid is obtained along with trachylolic acid by lead acetate, the lead of which is not precipitated but remains in solution. Filtered from the lead trachyloilate, and the filtrate shaken with sulphuric acid, lead sulphate is precipitated and the second acid is dissolved in the alcohol. It may be isolated by precipitation with water. Isotrachylolic acid has, as its name indicates, the same formula as trachylolic acid. It melts at 105-107° C. and is differentiated as follows from trachylolic acid:—

TABLE XII.—SHOWING POINTS OF DIFFERENTIATION BETWEEN TRACHYLOLIC AND ISOTRACHYLOLIC ACID.

| Trachylolic Acid. |  | Isotrachylolic Acid. |   |
|-------------------|--|----------------------|---|
| 1                 | Only slightly soluble in acetone ether and chloroform.   | 1                    | Readily and completely soluble in ether acetone and chloroform. |
| 2                 | Precipitated by lead acetate.                            | 2                    | Not precipitated.   |
| 3                 | Melting-point, 168° C.                                   | 3                    | Melting-point, 105-107° C.                                      |
| 4                 | Acetyl derivative slightly soluble in carbon disulphide. | 4                    | Acetyl derivative completely soluble in carbon disulphide.      |

Isotrachylolic acid is optically inactive. It dissolves in concentrated sulphuric acid with a red colour and deep green fluorescence. It dissolves in ether, alcohol, chloroform, acetic acid, but not in benzol or toluol. Elementary analysis gave the following: Found mean of two analyses, C=75.89, H=9.90. Calculated C=75.68, H=9.91. Titration with decinormal alkali gave: Found K=7.8. Calculated for  $C_{56}H_{86}K_2O_8$ , K=8.09 per cent. The copper salt gave Cu=6.60. Calculated (for  $C_{56}H_{86}CuO_8$ ) Cu=6.63 per cent. Acetylated with acetic anhydride at 190° C. isotrachylolic acid yielded an acetyl derivative, readily soluble in chloroform, ether, toluol, benzol and carbon disulphide, slightly soluble in alcohol and insoluble in petroleum ether, melting at 82° C. and yielding the following analysis: Found mean of two analyses, C=74.66, H=9.04. Calculated for  $C_{56}H_{87}O_8 \cdot CH_3CO$ , C=74.84, H=9.68 per cent. There is therefore also in isotrachylolic acid a hydroxyl group and two atoms of hydrogen replaceable by a metal. The formula of  $C_{54}H_{85}O_3OH \cdot (COOH)_2$  is given to it. The amount of trachylolic acid contained in Zanzibar copal is 80 per cent., of isotrachylolic acid 4 per cent.

On agitating the ethereal solution of the pure resin with alkalies a point is reached when no more is extracted. The resene and the ethereal oil are then left in solution in the ether. The ethereal oil can be removed by steam distillation. It amounts to 3 per cent.



The resene mixture is then heated with potash to free it from all substances soluble in potash, then the potash is taken up by water and shaken up with ether. The ether extracts copal resene A therefrom. The very inert substance is dissolved in alcohol. The solution reacts neutral. It dissolves in acetone, chloroform, acetic acid; it is barely soluble in benzol and toluol and is insoluble in dilute or strong caustic potash, petroleum ether and carbon disul-



FIG. 7.—Mozambique Copal-tree (*Hymenaea Mossambicensis*). Flowering branch.

phide. It cannot be acetylated. Its alcoholic solution deviates the plane of polarisation to the left to the extent of  $[\alpha] D = -12.56^\circ$ .

Copal resene A yielded the following results on analysis: Found mean of three analyses, C = 78.98, H = 10.89. Calculated for  $C_{41}H_{68}O_4$ , C = 78.85, H = 10.90 per cent. The portion insoluble in ether contained B copal resene. It dissolves in acetone, chloroform, alcohol, ether-alcohol, is insoluble in alkalies, benzol, toluol, carbon disulphide and ether. Neither can it be acetylated. It is optically inactive.

Its solution reacts neutral. Analysed, copal resene B gave the following results: Found mean of two analyses, C=74.83, H=9.68. Calculated for  $C_{25}H_{38}O_4$ , C=74.62, H=9.45 per cent.

#### FOSSIL ZANZIBAR COPAL (GUM ANIMÉ).

The true fossil ripe Zanzibar copal, the *sandarusi* proper, has long been supposed to have been the product of the same species as now yield the raw or recent copal. But according to Perrot, who has conclusively shown that both fossil and recent Zanzibar copal is produced by *Trachylobium*, the identity of the fossil kind with *T. verrucosum* is not quite proven, as there are no flowers remaining on the fossil species to decide the point. Livingstone explained the fossilisation of the resin thus. The tree, perforated by the larvæ of insects, exuded masses of resin which, falling from the trunk and large branches, have in course of time been embedded in the soil, forming the deposits which are rediscovered at the present day, all of which is quite possible. But it is a positive fact that from wounds made on the roots accidentally or otherwise, considerable quantities of resin may flow, and accumulating underground become fossilised. This has been observed to occur in the case of the *Hymenæa Courbaril*, and is an absolute fact as regards the *Dammara* in the case of Kauri.

*Gum Animé in Early Days.*—All gum animé, says Wilson Neil, is imported from the East Indies (p. 30), and is sold at the company's sales (that was at sales of the then East India Company, now defunct) in lots of two chests, each weighing from 3 to 5 cwt., the sizes varying much as well as the quality. The chests which contain the palest and largest gum always sell for the highest price, particularly those chests which are assorted already scraped; as there are great quantities imported which come over unscraped, and is termed "pickled," that is, cleaned from its rust by lying for several days in a very strong alkali, well washed with a broom and afterwards washed with water. This sort is not so good as that which is scraped with the knife, and in general it sells for one-third less than that which is scraped; but in picking and sorting animé observe and pick out all the fine large and transparent pieces first—these call "body gum"; then pick and sort the remainder as directed for the copal-making, three sorts. Recollect all sorts of gums can be procured ready picked and sorted from the gum merchants and dealers.

Sometimes the fossil resin is found when sinking hut piles; at other times it is left by a high tide on the foreshore. According to Burton, the copal coast extends along the sea-board from Ras Gomani in south latitude 3°, to Ras Delgado in 10° 41', stretching inland with an average breadth of thirty miles. The whole of this district contributes its quota of the copal sent to market. The greater bulk, if not the whole, of this district would now appear to be included in German East African territory. But even a small section of this

tract, from the mouth of the Panguni river to Ngao (Monghou), would, if systematically exploited, meet all demands. Even in the most abundant deposits it is only found in nests or patches, thus probably indicating that it was the product of isolated individual trees. The natives work the deposits very unmethodically. Unless they strike resin at the first trial, they go no further, but dig fresh holes in the loose, sandy soil in which it is principally found, until finally they come upon resin. As a rule, the redder the soil the better is the copal. On the island of Zanzibar the copal, consisting entirely of *chakazi*, is found in the vegetable mould overlying a sub-soil of blue clay. The finest and best fossil copal is found on the banks of the Rufiji river, particularly in the north district of Wandé, now German territory, and is brought to the coast by travelling dealers or the natives who dig it. Cameron was assured by Arabs that they have found it in digging wells even in the centre of the continent.

*Method of Collecting.*—The method of collecting the resin is very simple. A hole about 6 inches wide is dug out of the earth with a sharp stick, and the earth removed by hand as far as the arm can reach. The mean quantity gathered in a day by a native is about 1 lb., but he could easily gather ten times that quantity. Digging cannot be carried on in the dry season, as the resin is then very brittle, and the rude native tools unsuitable, owing to the hardness of the ground; hence working is confined to the rainy season (April-October).

*Washing.*—When the rainy season is over, the unsorted copal is taken to Zanzibar, where it is sifted from extraneous matter before exportation. It is also sometimes cleaned here. This operation is performed by brushing the resin in vats, into which a current of water runs, or, better still, by washing with a dilute alkaline lye containing 2 per cent. of potash, and then rinsing well in pure water, so as to leave no trace of alkali on the resin. It has now lost about 20 per cent. of its bulk. The resin is then sun-dried for some hours, taking great care to avoid dust and dirt being incorporated with the resin. It is then brushed sufficiently hard to remove the outer crust, but leaving the goose skin intact. The dirt still lurking in any hollows is removed by a knife.

*Goose Skin.*—Some authorities hold that the peculiar puncturing of the surface of copal known as "goose skin" is due to the liquid resin falling upon sand, and the peculiar hollows which give rise to the appearance are simply the imprints of the sand. It is contended, on the other hand, that these markings are due to the conformation of the woody fibre of the tree itself. It has also been pointed out that the flow of resin, always a sign of weakness on the part of the plant, increases with age and decay, and that it is the tissues of the wood surrounding the aggregation of resin which imprints the goose-skin structure thereon. As an actual fact this process goes on in the case of trees existing at the present day. As the trees which yielded fossil copal decayed and in the course of

time became completely converted into mould through the ordinary natural agencies, the resin which resisted all natural destructive forces became imbedded in the drifting sands, which swamped the district on which the primeval forest stood. When first dug up the resin does not show the goose skin, owing to its being covered with a crust produced by the action of the soil and natural elements. This skin can be easily removed by washing in an alkaline lye bringing the goose skin into bold relief.

*Garbling.*—This is the next operation; it requires skill and knowledge on the part of the workman. The gum is sorted out into pieces of the same size, colour, hardness, etc. Hence the necessity of experience, and the ability to recognise the different sorts at sight, the different degrees of hardness, and shades of colour passing from white and transparent through lemon-yellow to bright red, blackish and greenish. It is, however, often exported in the crude state to the East Indies and America, there to be washed and garbled.

The copal which comes to the European market is all cleansed on the spot before exportation. The best brands are those of Oswald & Co., of London, Zanzibar and Hamburg. Colour is represented by the initial letter W = white, R = red. Size of the pieces by A, B, C, and so on; thus WA = white large, RB = red medium. The semi-transparent plates, varying in size from that of a three-penny bit to that of a crown piece, and in thickness from  $\frac{1}{4}$  to  $\frac{1}{2}$  of an inch, are in general the best. The darker varieties consist of irregularly shaped rounded masses or angular lumps with occasional globules, the size varying from that of a pea to that of a man's fist. The weight of individual pieces of the darker sorts varies from 2 to 3 oz., whilst sometimes lumps weighing from 5 to 35 lb. have been unearthed. The melting-point of Zanzibar copal is about 280° C., at which temperature it gives off 10 per cent. of an essential oil, copal oil. According to Sir John Kirk the exports of copal from Zanzibar sometimes reach 800,000 lb., value £60,000.

#### MOZAMBIQUE COPAL.

This resin is collected in Mozambique and Nyassaland, in which there are large copal forests. In 1883 the British Consul at Mozambique reported the discovery, at Inhambane, of a tract of copal forest 200 miles long, extending inland for 100 miles parallel with the coast. Samples of this new fossil copal, accompanied by fragments of leaves and bark, were sent to Kew, and upon practical tests being made upon its suitability for varnish-making it was favourably reported on by Mr. Ingham Clark, and valued at from £80 to £100 per ton. It is said to be very similar to Zanzibar copal, even to the so-called goose skin, but Mr. Clark regarded it as similar to Akra copal, melting at about 330° F. The natives call the gum *stakate* and *staka*, the Zulu *Inthlata*. Some of these samples are now contained in the museum at Kew.

An extract from a letter from Inhambane, of date 5th February,

1886, states: "Many tons of copal have been exported from Inhambane. For some pieces I have received as high as £13 10s. per cwt. The average price realised on large lots has been £7 per cwt. The forest containing the trees extends from the River Sabia, in a south-westerly direction, as far as Beleni." With reference to the statement that the discoverer had collected six tons of this resin with the intention of sending it to England, Jackson remarks it seems never to have arrived, unless it entered the market under the guise of an old-established name to ensure its sale.

It has been variously described as the product of *Copaiba Conjugata* (Bolle, O. Ktze), *Gorskia Conjugata* (Bolle), *Copaifera Gorskiana* (Benth), or *Copaifera Mopane* (J. Kirk).

*Properties.*—This resin is met with in the form of thin plates or flattened globules, varying in size from  $\frac{1}{4}$  of an inch to 2 ins.; the colour is sherry yellow, often inclining to red. Pale yellow pieces are seldom met with; the fissures running through the resin are red, so also is the crust or efflorescence on the surface of the resin when freshly dug up. The surface is warty but without the regularly-shaped facets of Zanzibar copal. The fracture is conchoidal, the lustre vitreous, and the resin has neither smell nor taste. Its density is 1.069.

Fresh seeds were also received at Kew, and several hundred plants raised from them, which have been distributed from Kew to India, Singapore, Jamaica, Trinidad, Demerara, Dominica, and tropical parts of Australia.

#### MADAGASCAR COPAL.

The copal-tree of Madagascar (Fig. 8), is a very large tree, with a straight cylindrical trunk, and a girth, 40 inches above ground, of about 100 inches. It attains a height of 115-130 feet. The leaves, with caducous stipules, are bifoliated with coriaceous leaflets. The white flowers form panicles at the extremity of the branches, the inflorescence bracts and bractlets fall before anthesis. The turbinated calyx tube has four imbricated segments. The five almost equal petals, each provided with a claw, are imbricated. There are ten free stamens, the filaments of which are slightly pubescent at the base, with elongated anthers and longitudinal dehiscence. The ovary, with few ovules, is surmounted by a filiform style, with bent stigma. The oblong trispermous pod, with its thick coriaceous, rugose and wrinkled surfaced pericarp, contains in its interior resiniferous cells, the yellowish contents of which exude exteriorly on ripening. The seed has an embryo with fleshy cotyledons. The Malguches (the natives of Madagascar) call this copal-tree "Tsimatsy Mangoto" in the province of Diego Suarez; "Mandrirofo" in the province of Maroantsetra, and "Mandrorofy" in the region of Masoala. The product for which the native searches is the hard fossil copal which has exuded from the tree in bygone ages, and formed more or less abundant deposits in the ground at his foot. To get access to it he digs holes at the foot of the trees,

sometimes, unfortunately, so far as to uproot them. The natives also collect the resin which sweats from all parts of the living tree. They regard this tree with respect, and contrary to the practice adopted in regard to certain plants, india-rubber trees, for example, which they fell in order to collect the latex, they rest content with making incisions on the bark of the copal-tree, from which the resin flows. It will be seen on examining the section, Fig. 9, that superficial incisions piercing the bark only suffice for the maximum collection of raw copal. The copal-tree undoubtedly grows all over Madagascar,



FIG. 8.—Madagascar Copal-tree (*Hymenaea Verrucosa*). Flowering branch and fruit.

but more abundantly in the North and on the Eastern watershed of the large island, according to information published since the island came into the hands of the French, most of which has appeared in *Notes, Reconnaissances and Explorations in Madagascar*, a monthly review published at Tananarivo. Chapotte in his notes on the forest of Masoala says this tree has a predilection for sandy soils on which it grows abundantly. It is met with more rarely on red clay, but always at a very low altitude. Somewhat abundant in the valley of Mahavelona, it is completely wanting on the watershed of the Bay of Antongil, remains rather rare from Masoala to N'gontsy,

and becomes more abundant between Andraraony and Antalaha. It exists, finally, although more rare, in the valley of Antsahanandriana. In his remarks on the northern region, which extends from Tananarivo to Diego Suarez, Lieut. Boucabelle says that the copal-tree grows generally in isolated clusters, real islets in the forest, and which generally prefer low-lying damp ground on the deeply ravined slopes scorched by the sun. The tree, in fact, thrives in the valleys and frequents humid ground. But copal collection is only an accessory to that of rubber. By itself it is not sufficiently remunerative—the pound of resin does not sell for more than 5d. It is therefore gathered

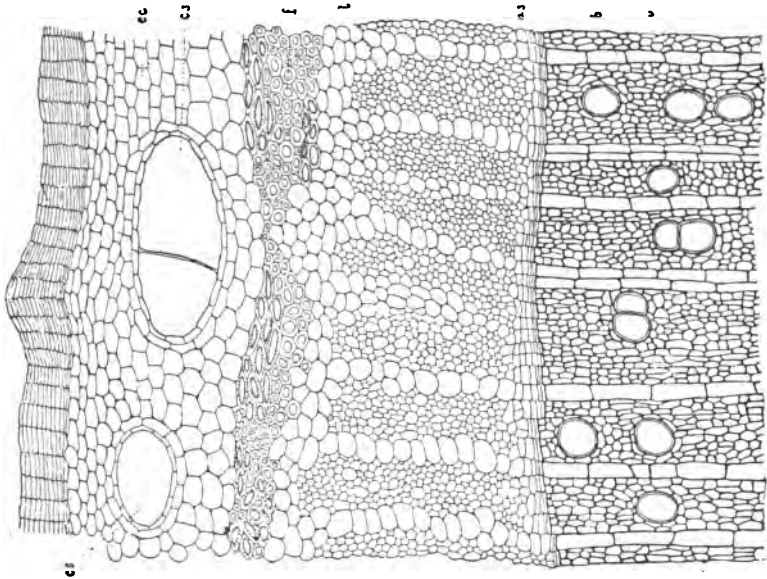

FIG. 9.—*Hymenaea Verrucosa* of Madagascar (Gaertner).

Transverse section of a branch—*s*, cork; *ec*, bark; *cs*, oleo-resin secreting vessels developed exclusively in the cortical zone; *f*, pericyclic fibres forming a continuous layer of variable thickness; *l*, liber; *b*, wood; *as*, libero-ligneous generating layer; *v*, wood vessel.

by the rubber collectors, who complete with a few pounds of copal the loads which they bring to the coast. The whole of this traffic is, moreover, in the hands of Indians and Arabs established at Vohehar and at Diego Suarez. Captain Lafort, during his expedition in the south of the colony, has noted that the copal-tree, notwithstanding the vigour with which it grows, has almost completely disappeared from the coast, either because the trees have been destroyed by fire or uprooted by those in search of fossil copal.

The natives of Madagascar understand the uses of copal, and those in easy circumstances use it to varnish furniture, either bought or made on the spot. But it is more particularly for exportation that

the resin is collected, and as both the recent and fossil resin are met with in commerce, very possibly the two kinds are mixed in the lots put on the market. In any case, copal is sold in Madagascar at prices which vary in the different provinces. In Mahanaro, a district of the province of Andevoranty, copal is found in abundance. Its present price is £1 per cwt. The annual exportation is about one ton. In the province of Manangary copal is also wrought, where it is worth 12s. a cwt. in the provincial markets. According to Chapotte, the same product is exploited in the neighbourhood of Antalaha, and a small trade is done in it on the Tamatave market, where the resin is sold at £3 the cwt., and 4.68 tons were exported from the 1st of January to the 1st of October. Copal, says Captain Rossi, is very abundant in the province of Maraonsetra, chiefly in the neighbourhood of Maraonsetra, where pieces weighing 1 lb. are to be found. However, for want of purchasers, the natives do not collect it. It would appear evident, however, that in a few years the better-known product will become the object of methodical working. Prime quality Madagascar copal is quoted in Europe at 4 francs the kilogramme, say 17d. the lb. A more recent report says: "Considerable quantities of gum resin are exported from Madagascar, especially from the east coast. The article resembles amber in appearance, is reddish-yellow to yellow-white in colour, has a vitreous fracture, and occurs in rounded lumps. According to Dubosc, the density is 1.054, the melting-point 527° C. (the mass beginning to soften at 105° C.), the acid value 78.5. The copal is practically insoluble in cold alcohol, ether, methyl alcohol, benzol, acetone and carbon tetrachloride, but is soluble to the extent of about 25 per cent. in the warm. A larger proportion dissolves in oil of turpentine, chloroform and amyl alcohol, a good deal in aniline and amyl acetate, and most of all in benzaldehyde. The mass swells up considerably in ether and amyl alcohol, and is at the same time decolorised; with aniline it forms a reddish-yellow."

*Action of Naphthalene upon Madagascar Copal.*—The method by which the copal gums ordinarily used in varnish-making are rendered soluble by a fusion process, whereby they lose about 25 per cent. of their weight, is well known to those connected with the varnish industry; but it is a less well-known fact that, by heating certain copals under pressure with naphthalene, a change in the properties of the copal takes place, whereby the gum becomes soluble in oil in very much the same manner that results from the usual fusion process. Coffignier has recently compared the properties of a Madagascar copal with those of the same gum rendered soluble by fusion and by heating with naphthalene under pressure. He points out that the advantages of the latter method are several, and include (1) no loss in weight; (2) the resulting product is pale in colour; (3) the hardness of the gum is practically unimpaired. A curious point observed was that in the naphthalene process the specific gravity of the product is very much higher than that of the original copal.



Thus, the original copal had a specific gravity of 1.058; after fusion in the usual manner, the specific gravity was 1.062, and after the naphthalene process the specific gravity was 1.961. The melting-point was also altered to a noteworthy degree. In the case under consideration, the melting-point of the original copal was about 300° C.; after fusion, 205° C., and after the naphthalene process, 165° C. Certain of the solubility figures were also altered. Thus, in the original copal 60.3 per cent. was insoluble in spirits of turpentine; in the fused product, 3.6 per cent. was insoluble, and after the naphthalene process 52.1 per cent. was insoluble in the same medium. The original copal was insoluble in aniline to the extent of 17.8 per cent.; in the same medium the fused copal formed a gelatinous mass, but the naphthalene product was wholly insoluble in the liquid. These facts would seem to indicate that considerable practical experimenting would be advisable before the naphthalene process of rendering gums insoluble can be adopted with perfect confidence in varnish-making. The lowering of the melting-point and the difference in solubility in turpentine would appear to the practical varnish-maker to be facts in the wrong direction. Moreover, the fact that solid camphor and solid naphthalene unite to form a greasy liquid speaks volumes against the introduction of naphthalene into varnish; mere solution is not enough. Naphthalene would no doubt act somewhat as described on all varieties of copals. Its action on Madagascar copal is given here to complete the chemical history of that resin so far as known.

*Group II.: West African Copals.*—Copal is still more abundant on the west than on the south-east coast of Africa, being dug over 700 miles of coast-line between 8° N. and 14° S., including therein the coast-lines of Sierra Leone, Ashanti, Dahomey, French Congo, Congo Free State and Angola. The main varieties, known by the localities from which they come, are Sierra Leone (recent and fossil), Accra, Angola, Benguela, Benin, Congo, Gaboon, Loango. The fossil copal is found at various depths up to 10 feet from the surface embedded in layers of marl, sand and clay. The young copals of Sierra Leone likewise come from a species of Leguminosa for which Bennet created the genus *Gibourtia*, but which, according to Bentham and Hooker, also Baillon, should be included amongst the *Copaifera*. However, Dewevre (*Useful Plants of the Congo*) says that the *Hymenaea Verrucosa*, which exists in the forests in the region of the lakes, has been found in the Congo by Livingstone at Bomba, and by Cameron at Nyangwa. The copal-tree is not therefore rare in the Upper Congo, and some samples are even met with, according to R. P. Mirlon, at Moyon and on the Lower Congo. The fossil copal of the Upper Congo may therefore be due to the exudation of ancient forests of *Hymenaea Verrucosa*. But the dominant species of "copaliferous" tree in West Africa at the present day is the *Copaifera Copaline*. It is a large tree which by its bifoliated leaves with coriaceous leaflets recalls the *Hymenaea*. The flowers are in forming panicles.

The calyx has four imbricated sepals, the corolla is awanting. The stamens, eight to ten, are free, with glabrous filaments with anthers dehiscent longitudinally. The biovulated sessile ovary is free; at the bottom of the calyx it is surmounted by a filiform style terminated by a truncated stigma. The fruit is unknown. This tree is called "Kobo" by the natives. It grows in Upper Guinea, Sierra Leone, Gaboon, Congo and the Ivory Coast. It is met with especially on the outlying flanks of the mountains of Fonta Djallon at an altitude of 400-600 metres, where it frequents humid spots and ferruginous clay soils. As on the east coast, copal is found on the west coast under two distinct forms: *raw* copal, collected from living trees, and *fossil* copal, embedded underground, the product of extinct forests. The copal-bearing trees of the west coast of Africa are exploited as follows. The trunk of the Kobo is covered by a rugose bark; it bears no branches until it reaches a considerable height above the soil. The resin flows from the tree, from all the fissures, as whitish tears passing to greenish or lemon yellow, darkening by the action of air and light and becoming covered by a white efflorescence. The negroes climb the trees, stop at the first branches, the bark of which they incise, then they incise the bark of the trunk which is easily penetrated by the knife. They fix small clay pots underneath, which are replaced by others in two or three days' time. The first are emptied and their contents kneaded into balls, which are sun-dried. The collectors also gather the fine tears exuding spontaneously from the trunk which sometimes run into bulky masses. When the negroes think they have collected enough, they bring it to the coast to sell it or barter it at the settlements for various merchandise. There is a big trade done in this resin at Sierra Leone. The fossil copal is much more esteemed. It is found in the soil at depths of 20-40 inches. As in East Africa the deposits occupy the site where the copal-tree has almost disappeared, but as in Mozambique the negroes do not take kindly to searching for it and digging it which is somewhat laborious. Savernau de Brazza discovered abundant unwrought deposits of very pure, pale yellow, large blocks of fossil copal in Upper Alima. It is even found, it is said, in the environs of Freetown. These few years back the deposits of fossil copal in the Belgian Congo have been energetically wrought, and since the erection of the railway the product dug up in the Upper Congo is easily transported to the coast, where it is shipped to Belgium. There is now, therefore, a regular market for African copal in Belgium. During the last quarter of 1897, 26,889 francs, say £1,075, worth of this resin was exported from Konakry. England took 16,582 francs worth, say £663; Germany 888 francs, say £35 worth; Sierra Leone 9,419 francs, say £375 worth. The exportation of copal from the Ivory Coast rose during the last quarter of 1897 to 310 kilogrammes, whilst during the corresponding period of 1896 it was only 225 kilogrammes.

The French are drawing what consolation they can from these figures as showing that this product is likely to become an important

article of commerce for the French settlements on the west coast of Africa, and that the Sierra Leone dealers themselves come to Konakry to get supplies. The projected railways, it is hoped, will further develop the trade.

In any description of West African copals special mention must be made of Angola and Benguela copal. It is a fossil resin met with on the coast-line from the Zaire or Congo to the river Nourse or Cunene. All this region has undulating land, hills and uplands forming the outlying slopes of the mountains rising higher towards the east; it is mostly arid; all arborescent species are too diminutive—almost shrubs. Copal is found in different districts in this territory in points not far distant from the coast. Welwitsch indicates as the principal deposits the country stretching from the south of the Congo near to Novo Redondo, Egito and Benguela. The most important markets where this copal is dealt in are Ambres, Loando, Novo Redondo, Benguela and Mossamedes.

The fossil resin is found in the surface layers of soil; it would appear to be often found in the depressions or gullies excavated by rains. It is also found embedded at more considerable depths in sands or beds of clay. According to Welwitsch, Angola copal is always fossil, but it differs completely in character from East African copal. Like the latter, however, it is the result of considerable deposits of resin exuded from extinct forests in which copal-trees abounded, the cause of the destruction of which is difficult to determine. Two principal varieties of Angola copal have to be distinguished, the *red* Angola copal, which is the most esteemed and the dearest, and the *white* Angola copal, regarded as inferior. It is possible that several species of copal have aided in forming the enormous quantity of fossiliferous resin in this part of Africa; it is also probable that the species belong for the most part to the *Copaiifera*, and that they still exist, although more rare and sparingly, across the African continent. In any case as regards the origin of Angola copal it would appear right to suppose that the *red* variety of this copal is a product of the *Copaiifera Mopane* (Kirk), a species which, according to Welwitsch himself, exudes a blood-coloured resin comparable with dragon's-blood. The *Mopane* frequents the arid desert tracts of South Africa. In the west it thrives in the dry sandy land to the north of Cunene and the neighbourhood of Mossamedes. Towards the east it constitutes, according to Kirk, on the banks of Zambesi vast monotonous forests extending over dry arid plains. The origin of the white sort is more obscure. It would not appear to be the *Copaiifera Copallina*, which we have seen frequents humid situations and clayey but not sandy soils. Perhaps it may, says Cordemoy, be referred to that species determined as *C. Conjugata* by the Kew naturalists, which abounds in south-east Africa and is the source of Inhambane copal. But Jackson refers the source of this variety to *Copaiifera Gorskiana*. Angola copal was discovered in 1622 in Angola by Bento Banha Cardoso. From 1820 onwards a considerable and

gradually increasing trade was done in it in the ports of the province. From 1850 to 1858 or 1859 there were exported annually from Angola ports over 300 tons of copal, more than three-fourths of which were Benguela. The whole of this exportation was absorbed by the U.S.A., so during the Civil War the exportation considerably diminished. The copal trade was resumed later on but without regaining its original dimensions, and the average of the exportations during 1870, 1871 and 1872 did not reach 300 tons. According to a recent Consular Report (1907), the collection of copal in Angola is being neglected. The detailed description of red and white Angola is given further on.

*Detailed Description of Different Varieties of West African Copal.*

—The principal varieties distinguished by the names of the localities from which they are derived are *Sierra Leone, Angola, Benguela, Accra, Benin, Loango, Gaboon, Congo*. The young copals of Sierra Leone and Accra are the products of species of *Gibourtia*. Angola, Benguela, Congo, etc., copals are generally fossil resins.

*Sierra Leone Copal.*—The water-rubbed, and rolled, and rounded forms of Sierra Leone copal—the so-called *Pebble copal*—found between the rivers Pongas and Malaenzi, would seem to indicate that at some time or other the resin had been transported by running water from some considerable distance inland to the coast. The *young copal*, specific gravity 1.06, is found in bright nut-shaped pieces, sometimes in tears, with a strong aromatic odour; it melts at 195° C. *Pebble Copal (Sierra Leone)*, specific gravity 1.055, is found principally in the form of small pebbles in the neighbourhood of Cape Verde, not unlike amber, colourless or white to a bright yellow, transparent or translucent, sometimes but rarely partially covered with a fine-grained opaque whitish crust. The pebbles vary in size from that of a pea to a large-sized pigeon's egg. Larger pieces are occasionally but seldom met with. It is the hardest of the West African copals, ranking in this respect next to Zanzibar copal. It melts at a high temperature, and by dry distillation yields an essential oil so neutral that even concentrated potash solution is said not to attack it. According to Tschirsch, 45 per cent. is insoluble in alcohol-ether. The ethereal solution cedes 14 per cent. to caustic potash.

*Valuation of Sierra Leone Copal for Varnish-making.*—Gum copals, says Wilson Neil, are of three different sorts and qualities; the best is brought from Sierra Leone in Africa, and when imported is about the size of small potatoes, and is covered all over with a rough coat of dust or claylike substance. It is most commonly bought in that state by varnish-makers, gum dealers and druggists, who scrape it bit by bit with sharp penknives or razors; it is rather pared than cut quite free from dust; it is afterwards picked by hand into three different qualities. All the finest and palest is put by itself—this call "body gum"; pick out the next best, and placing it by itself call it "carriage gum". From the remainder pick out all pieces of wood,

stones, etc., leaving the third or worst quality which serves for gold size or Japan black.

*Accra Copal* occurs in shapeless pieces of about an inch in length by an inch in breadth, of a bone-like appearance, whitish in colour, according to Andès, but clear yellow, according to Tschirsch, and covered with a very fine whitish efflorescence which when removed shows a striated wavy appearance which serves to differentiate it from other resins. Sometimes it presents a uniform cloudy surface, especially in the case of those pieces of a pronounced bone-like form. In hardness it comes next to Angola. Its smell recalls that of camphor (Tschirsch); tasteless and inodorous (Andès). (See pp. 67-69.)

*Benin Copal* is found in irregular white, yellow or red pieces, covered with a thin yellow or red opaque crust, but does not exhibit facets after removal of the crust, often contains impurities, generally globular or tumour shaped, less often in plates. It is similar to Accra copal but softer. Fracture generally glassy. Less esteemed than Angola. In alcohol-ether 45 per cent. is insoluble. The ethereal solution cedes 25 per cent. to potash (Tschirsch).

*Loango Copal* (specific gravity 1.064, Stinghl), which is found in globular lumps or in stalactitic sticks sometimes 12 to 15 inches in length, and which must have been of an indefinite length originally, is much esteemed because of its hardness and homogeneity. The colour is white, yellow and red, and these colours may be again subdivided. There is, however, on the surface a thin reddish layer. The surface is covered with so thin an efflorescence, easy to rub off, that the surface is often quite smooth or covered with excrescences. The fracture is conchoidal with glistening surfaces and the scratch line shows no splinter. The red variety being the harder, the more transparent and the most uniform is the most esteemed. The smell is feeble and not very characteristic, terebinthinous. The powder when masticated does not adhere to the teeth. In alcohol-ether 37.5 per cent. is insoluble. The ethereal solution cedes 35 per cent. to potash.

*Gaboon Copal* (specific gravity 1.073, Stinghl) is found in rather large size, flattened or rounded pieces  $\frac{1}{2}$  to 3 inches in diameter. Its yellowish-red colour passes sometimes to white with blood-red streaks in it. Its surface is, in general, smooth white, with a very thin characteristic chalk-like crust and permeated by raised ledges. The fracture is conchoidal to splintering and of a vitreous lustre; when fresh, the scratch on new surfaces is smooth, on old surfaces splintering. Masticated, the powder adheres to the teeth (Tschirsch).

*Cameroon Copal* (specific gravity 1.08).—This copal, which comes from the Dutch settlements in West Africa, is in all probability derived from a variety of copiferous tree. It comes to market as fine, large, cloudy or semi-transparent, pale yellow or pale yellowish-red lumps with a bright or almost bright fracture. Smell feeble but characteristic like cedar wood. In alcohol-ether 42.5 per cent. is insoluble. The ether solution cedes 15 per cent. to potash. It is the finest of the West African copals. Hardness the same as rock salt.

In quality is about equal to Kauri. Another copal with nothing very particular to recommend it, covered with a whitish-grey crust, comes from the Dutch Togo provinces (see also pp. 67-69).

*Congo Copal.*—White Congo copal is derived, according to Gilg, from *Copaifera Demeussi* (Harms), but the *Cynometea Sessiflora* (Harms) of the Congo also secretes copal. Congo copal comes to market in the form of white to pale yellow to brownish-red highly irregular very angular pieces covered with a white to red thin crust. The fracture is conchoidal with a glassy lustre. The facetting of the surface is barely perceptible. The lumps, especially in the white varieties, are greatly permeated by plant débris. The good sorts are very hard, transparent, almost colourless, limped. They begin to melt at 140-150° C., liquefying at 220 or 230° C. and perfectly liquid at 240° C. The smell is feebly like copaiba balsam. In alcohol-ether 42·5 per cent. is insoluble, and the ethereal solution cedes 28 per cent. to caustic potash (Tschirsch). Puscher, in 1867, communicated to the Industrial Society of Nuremberg the result of his experiments on Congo copal. According to him the resin dissolves easily in cold absolute alcohol, ether, spirits of turpentine and even in ordinary alcohol, leaving a slight residue. One part of this copal, one part linseed, and two parts of spirits of turpentine yield a perfectly transparent oil varnish. But the resin experimented on by Puscher melted at a much lower temperature than that given above. It melted at 85-90° C. In any case very durable bright pale, almost colourless, varnishes are made from this resin in Belgium.

*Angola Copal* (specific gravity 1·065).—This kind is met with in several varieties which differ from each other as much in colour as in hardness. The coloured varieties are brighter, more transparent and homogeneous than the duller and paler kinds. It occurs as rounded or globular, rarely flattened pieces of about 1½ to 2 inches in diameter, and covered naturally with an earthy dirty white to brown crust to a greater extent than any other copal. The *yellow* variety is covered with a reddish efflorescence. It is transparent and hard, and distinguished for its facets, similar to those of Zanzibar copal. It is found in the three forms named above. The *red* variety, the most highly esteemed, is rounded, irregular, with a hard opaque red crust to a depth of almost one-fifth of the diameter. It is sometimes irregularly faceted, or studded with crevasses. This red variety is one of the hardest copals of the west coast of Africa and is highly appreciated in America, but less so in Europe, where it sells at £3 10s. to £4 the cwt. Ether-alcohol dissolves 45 per cent., and the ethereal solution cedes 50 per cent. to potash.

*White Angola*, which is not so much esteemed and is softer than the red, occurs in flattened pieces, or as small nuts with yellowish or blackish portions, and covered with a white efflorescence. It is said to be often three-fourths brown or blackish and to contain much plant débris. The lumps are seldom bright in the interior, more often milky-cloudy, and from scarcely transparent to non-transparent. The colour of the interior (when no impurities) is pale yellow seldom inclined to

reddish ; the lumps, moreover, coalesce. Two kinds of this resin come to market, one hard and one soft ; both are odourless and tasteless. The powder of the white copal adheres to the teeth when masticated. The surface is mostly smooth, and here and there on pure hard lumps very distinctly faceted.

*Benguela Copal.*—This copal comes to market as uneven lumps from the size of the fist to that of the head, often very greatly covered by protuberances, and containing crevice-shaped indentations extending inwards as far as one-third of the lump. This outward appearance is characteristic and possessed by no other copal. The small lumps have a surface with protuberances, cavities and shallow indentations, and all Benguela copal is covered with a white opaque crust. As to hardness this copal equals red Angola. Smell and taste are not very characteristic, although a characteristic aromatic smell is given off on fusion. Yellow Benguela is more highly esteemed than Angola copal and is much sought after in Britain and Holland. It is worth about 1s. a lb.

*Bastard Angola.*—This resin comes to market generally as roundish, seldom flat, more often globular pieces with several whitish bands, less often covered with a reddish crust ; often deeply notched ridges are to be observed. Washed, this copal is pale yellow, transparent and very strong, but very irregularly faceted and wrinkled. It has, therefore, a warty appearance. It is tasteless and inodorous, and recalls ordinary red Angola, which it equals in hardness.

Coffignier examined three African copals known commercially as "Pebble" (p. 64), "Cameroon" (pp. 65, 66) and "Accra" (p. 65) ; the specimens were derived from a German firm, but their exact origin was otherwise unknown. The solubility of these copals in different solvents was determined partly by extraction in a Soxhlet, partly by direct heating with the solvents.

TABLE XIII.—SOLUBILITY PER CENT. OF PEBBLE, CAMEROON AND ACCRA COPALS IN VARIOUS SOLVENTS.

|                                | Pebble. | Cameroon. | Accra. |
|--------------------------------|---------|-----------|--------|
| Alcohol . . . . .              | 57·4    | 66·7      | 47·8   |
| Wood spirit . . . . .          | 65·5    | 78·0      | 62·8   |
| Amyl alcohol . . . . .         | 8·5     | 19·2      | 4·1    |
| Ether . . . . .                | 42·6    | 55·8      | 44·0   |
| Chloroform . . . . .           | 56·6    | 66·6      | 66·0   |
| Benzene . . . . .              | 61·6    | 71·8      | 66·9   |
| Acetone . . . . .              | 49·5    | 60·5      | 45·8   |
| Turpentine . . . . .           | 79·6    | 78·6      | 79·7   |
| Benzaldehyde . . . . .         | 11·6    | 22·8      | 10·1   |
| Aniline . . . . .              | 5·7     | 8·4       | 2·5    |
| Amyl acetate . . . . .         | 10·0    | 12·0      | 7·4    |
| Carbon tetrachloride . . . . . | 69·9    | 73·7      | 80·3   |

Certain solvents, *e.g.*, aniline and amyl alcohol, give solutions that may be considered as complete when we take into account the impurities that are always present in copals ; these solutions, however, cannot be considered as varnishes. Coffignier prepared certain varnishes with all three copals and found the Cameroon varnish

satisfactory. All these three copals are soluble in strong sulphuric acid; the solution when poured into water gives a precipitate that has very little colour and amounts to 99 per cent. of the original in the case of the Cameroon. Coffignier thus describes the three resins:—

(1) *Pebble* (specific gravity 1·066) forms irregular pieces, flattened or rounded, of the appearance of rolled pebbles; some pieces are very white, others yellowish-red; it is very brittle and has a brilliant lustrous fracture; it fused at 110° C. and gave a saponification value of 117·8 and an acid value of 70·4 (see p. 64).

(2) *Cameroon* (specific gravity 1·052) forms irregular pieces, hard and difficult to break and of a straw or reddish colour. It softens at about 100° and melts at 150° C. Acid value, 159·7 (see pp. 64, 65).

(3) *Accra* (specific gravity 1·033) comes from Accra, on the Gold Coast, and is now fairly well known. It has the appearance of irregular masses, of a yellowish-white colour and glassy fracture; some pieces are milky. It softens at 75° and fuses at 120°. Acid value, 97·8; saponification value, 140 (see p. 64 and *infra*).

*Gold Coast Copals*.—Three samples of copal resin from Ashanti were (1907) recently forwarded to the Imperial Institute by the Superintendent of Agriculture for the West African Colonies and Protectorates. These have been examined chemically at the Imperial Institute, and submitted to experts for valuation, with the following results:—

*Ashanti Copal*.—Sample No. 1, labelled “Dead tree copal, Obassi, Ashanti,” consisted of a single cake of resin weighing about 3 lb. The cake was dark coloured externally but the bulk of the resin had a yellow colour, thin sections being almost colourless and quite transparent. The resin had a slight aromatic odour, but no taste; it exhibited a conchoidal fracture, and was readily powdered. Sample No. 2, labelled “Gum copal from Eikona, Ashanti, said to occur plentifully, but no demand for it in Kumassi,” weighed about 1½ lb., and consisted of two varieties of resin, which differed considerably in appearance. (a) was a clear, light yellow resin of similar character to sample No. 1 from Obassi; it was quite transparent and devoid of taste; (b) was translucent, of light buff colour, and possessed a slight odour; occasional white opalescent patches occurred throughout the lump. Both portions were free from enclosed foreign matter. Sample No. 3, labelled “Gum copal from Oboamang, Ashanti, said to occur in some quantity in the forests, but not saleable in Kumassi,” consisted of several lumps of resin, which together weighed about 1 lb. The lumps varied in appearance, the majority being made up of several masses of clear or cloudy yellow resin interspersed with thin layers of foreign matter. Some of the outer cavities of the lumps were partly filled with a resin of much brighter yellow colour than the general mass. One large lump included in this sample was much superior in quality to the remainder, being light yellow, translucent and free from enclosed foreign matter. The results obtained in the chemical examination of the three samples are in general



agreement with the figures previously recorded for West African copal. The samples were only partially soluble in alcohol, benzene, carbon disulphide, chloroform, ether or turpentine oil, but were completely dissolved by mixtures of benzene and alcohol, turpentine oil and alcohol, or benzene and ether.

The resins were submitted to brokers for commercial valuation, and the following quotations were obtained: No. 1, 60s. per cwt.; No. 2, 50s. per cwt.; No. 3, 30s. per cwt. Sample No. 1 was also sent to a firm of manufacturers, who valued it at a much lower price than the brokers, *viz.*, 25s. to 47s. 6d. per cwt. It was stated that consignments similar to these samples could be sold without difficulty, as there is a good demand for copals of this class.

*Dirty Condition of Gold Coast Copal Deliveries as compared with those from Congo.*—The manufacturers pointed out that moderate quantities of copal from the Gold Coast were formerly received in this country, but owing to the diminution of the supplies, varnish-makers turned their attention to other varieties of copal, which can be regularly obtained in large quantities. Accra copal, the name by which the Gold Coast resin is known in the market, has so far never been held in very high favour, in consequence, it is thought, of the unsatisfactory way in which it has been shipped. The resin is usually sent in the rough state, with a large quantity of dust and dirt mixed with it, no attempt being made to separate the different qualities. Its value is thus considerably diminished. On the other hand, Congo copals, which are now largely used, are more or less graded for colour and sometimes for size. In addition, the dust and dirt are carefully removed, and many of the consignments are roughly washed. As a result of this treatment some of the clean sorted Congo copals realise from £120 to £150 per ton. There appears to be no reason why Gold Coast copal, if carefully cleaned and graded before shipment, should not realise satisfactory prices in the market. In grading, the copal is separated according to size and colour. The highest prices are obtained for the pale, translucent resin in large and uniform pieces; the darker or cloudy pieces realise less, whilst the dust and chips fetch the lowest prices. The most important point is to secure uniformity in shipments, so that manufacturers can be sure that successive consignments of the resin, if treated in the same way, will yield a similar product. The copal would realise a higher price if it were "washed" before shipment. This is usually done by scraping off the outer covering of dirt, dipping the scraped resin into a dilute alkaline solution, then into clean water, and finally drying. Further information is required regarding the origin of Accra copal. Some of the resin is apparently found in a fossilised or semi-fossilised condition, but at least a portion of it is stated to be derived from living trees. Information is being obtained as to the botanical identity of the latter.

*Ogea Gum.*—A hard fossil resin, said to be of the nature of copal, was introduced to notice in 1883 by Captain, now Sir Alfred, Moloney,

from the Gold Coast. It is described as being the produce of a leguminous tree closely allied to *Daniella thurifera*; for lack of proper material, however, its species has not yet been determined. The gum is used by the natives for lighting fires and for illuminating purposes; powdered, it is also used as a body perfume by the women. It exudes from the trunk either from wounds or from holes caused by the boring of insects. The gum has not yet appeared in commerce.

#### KAURI.

At one time only the very hard copals were available for oil varnish-making, and when the first lots of Kauri were put upon the market they could not find purchasers, but when their value was recognised they rose so enormously in price that the best kinds of Kauri eventually fetched prices higher than even Zanzibar copal. In Great Britain Kauri was much appreciated, and was very extensively used, long before Continental varnish-makers had come to regard it with favour. Of late, varnish-makers on the Continent have used large quantities of Manilla copal, a resin of a similar botanical, but not geographical, origin as Kauri, but British varnish-makers prefer Kauri to Manilla. Clarke, in fact, regards Manilla as quite unsuitable for oil varnish-making. So far back as 1870 Vincent, in a lecture before the Society of Arts, drew attention to the good and bad qualities of Kauri oil varnish. He more especially pointed out that if it yielded a very glossy and durable varnish for indoor work, it was not so very suitable for out-of-door application, as it did not withstand the weather very well.

*Kauri* is only found on the northern island of New Zealand, confined to a very restricted locality, because the *Dammara Australis*, the yellow pine yielding it, is confined to between S. latitude  $34\frac{1}{2}^{\circ}$  and  $37\frac{1}{2}^{\circ}$ , and it never descends below  $38^{\circ}$  S. latitude. There are some deposits of fossil resin between  $38^{\circ}$  and  $39^{\circ}$  in the district of Waikato, where the tree has for ages ceased to grow owing to the climate becoming colder. A few clusters of Kauris are still to be seen in a forest forty miles to the south of Auckland; but it does not reproduce itself in that locality, and no young trees exist there. The district lying between Auckland and the North Cape was formerly the sole domain of the Kauri. It is there the richest deposits of fossil resin occur. As a general rule, Kauri prefers a clay soil on steep slopes and escarpments amidst tree ferns. The living tree produces resin. But, like copal, the fossil variety dug out of the ground is the most esteemed. The deposits are often somewhat deep down below the surface, occurring in single lumps or in nests. The most abundant deposits are on the site of ancient forests of Kauri, which have long since disappeared, in soil now absolutely denuded of all vegetation. The best copal is found in high-lying, dry ground. That found in marsh land is not so highly esteemed. Sometimes these deposits are isolated or disseminated;

again, considerable deposits are exposed by agricultural operations—ploughing, draining and excavations for embankments. Moreover, the fossil product is found in forests in which the Kauri has not grown for ages, but great difficulty is experienced in digging for it on account of the innumerable roots penetrating in all directions. The resin flows abundantly from incisions made on trees now growing. It is perfectly white, and so soft as to be used by the Maoris for chewing. It has none of the amber colour due to fossilisation in the soil protected from air and light. It is probable that, owing to the gradual disappearance of the Kauri forests, new deposits of resin will not be formed, and that the present deposits will most likely be exhausted in less than fifty years.

There are thus three main varieties of Kauri to be differentiated—fossil, bush, and recent. Bush copal is also found in the soil, but chiefly around the roots of the tree from which it was exuded. Kauri resin was known to the Maoris long before the European occupation; they used it chiefly to light or to urge their fires on in carrying out certain religious ceremonies. On the establishment in 1841 of the British Colonial Government in New Zealand, a Mr. Busby, a merchant residing at Karorarika, in the Bay of the Isles, was the first trader to deal in this resin. The first annual exports to Sydney—under 100 tons—sold at £5 to £6 per ton. Good qualities now fetch twice as much per cwt. In the beginning, Maoris alone were employed in Kauri digging, but for many years 2,000 to 2,400 Europeans were wholly occupied in this industry. These gum diggers, if the most picturesque, were not the most desirable of European colonists at the Antipodes. They were recruited from convicts, adventurers, ne'er-do-weels and escaped convicts from New Caledonia. Without fixed residence or domicile, they lived in tents or huts. They camped preferably on unsold Crown land, and were greatly feared by the natives. They worked on their account, at their own risk. Their equipment was simple—a sort of lance and a shovel. Nothing could be more curious than to see an old gum digger stooping to the ground, which he sounded with an iron rod of about half an inch in diameter in a wooden handle ending in a sort of cross. By practice he learned to distinguish between contact underground with hard resin from that with a stone or other substance. After a successful boring he digs round about in a circle to get at his find. Sometimes they worked in pairs, one boring, the other digging. These gum diggers may earn from twelve to sixteen shillings a day, but owing to their irregular habits and to unequal chances of success their average weekly earnings per man did not exceed twenty-eight shillings. When the gum digger was tired of boring and digging he carried the gum in a bag to his hut, cleaned it roughly, and when he thought he had enough he sold it to small dealers who sometimes assorted it on the spot. Much gum was for years collected by migratory Austrians on the hire system at a weekly wage, and with truck system abuses which eventually led to legislation under which no alien can engage

in gum digging. The gum is nowadays assorted by the wholesale dealer in Auckland, who employs an experienced staff for the purpose. After a second cleansing and assortment the resin is carefully packed in cases so as to avoid any pressure which would break the pieces. It is then ready for export. The débris and waste are also exported.

The lumps of Kauri vary greatly in size and may weigh as much as 15 to 18 lb. Fluckiger states he saw a lump of 120 lb. at the Paris Exhibition of 1878. It is generally of an amber or dark yellow colour, but the colour varies greatly, and may be whitish, yellowish, smoky-grey, light brown or dark brown, very hard, and its fracture is vitreous and brilliant. It is transparent and sometimes perfectly limpid, but the transparency of different parts of the same piece may be very unequal. Every piece of any size, in fact, shows streaky and cloudy parts. It has no smell in the natural state, but when rubbed it emits a pleasant terebinthinous odour. All Kauri copals are covered with an opaque weathered crust, which is chalky in the New Zealand resin, but on the New Caledonian Kauri is brownish or blackish, with a metallic lustre in places. There is often a gradual transition from the crust-structure to that of the inside of the mass. If it is sharply differentiated from the internal part; the contours of the latter are jagged or wavy. The specific gravity of the New Zealand Kauri is 1.109, that of the New Caledonian Kauri 1.115. The fresh fracture is conchoidal, with a greasy lustre. All Kauri copals have a strong, pleasant, balsamic odour, and an aromatic taste. When chewed, the powdered resin sticks to the teeth. The following are the chief brands of Kauri copal on the market: Kauri Copal pale, Kauri Copal brown, Kauri Copal dark, Kauri Bush Copal, Kauri Copal extra fine pale, Kauri Copal  $\frac{1}{2}$  scraped, Kauri Copal pale ex Sydney, Kauri Copal brown  $\frac{2}{3}$  scraped, Kauri Copal 25 per cent. distilled off, Kauri Copal white, recent Kauri Copal natural and fossil natural.

As is well known, Kauri copal fuses rather easily, so that it is not difficult to combine it with drying oils and turpentine. This makes it easier to work with than East Asia copal. It is, however, stated that the fusion of the chips is sometimes difficult. Oil varnishes made from Kauri can be rubbed up with body-colours without thickening or undergoing decomposition. According to Bottler, the fused resin swells up in alcohol, and for the most part dissolves in it to a clear solution. Ether dissolves the copal partly, but a mixture of alcohol and ether dissolves it almost entirely. Chloroform, acetone, benzole and wood spirit dissolve the copal only slightly, even after fusion. Kauri stands third in Bottler's scale of fusibility.

New Zealand Kauri has been the object of numerous researches. In 1843 Robert Thompson examined samples of this resin brought by Dr. Ernst Dieffenbach, naturalist of the New Zealand Co. The pale amber-coloured resin melts at a low temperature, emitting a terebinthinous odour. It is partially soluble in cold dilute alcohol; it is more soluble in boiling dilute alcohol. Sulphuric acid dissolves, the resin water precipitates it in flakes. When Kauri is boiled in

ordinary alcohol one part of the resin dissolves, and there remains a white resin which is insoluble in weak alcohol but which forms with absolute alcohol a fine transparent solution. According to Thompson the portion of resin soluble in dilute alcohol possesses all the properties of an acid. He called this acid *dammaric* and assigned it the chemical formulæ  $C_{40}H_{62}O_7$  and also  $C_{40}H_{60} < \frac{H_2}{O}$  from Rose's

radical  $C_{40}H_{60} < \frac{H_2}{H_2}$ , and the neutral white residual resin soluble in absolute alcohol and forming 43 per cent. of the total he termed *dammarane*. He assigned to the resin the elementary composition represented by the formula  $C_{40}H_{62}O_6$ . In 1847 Dulk (*Pharm. Centralblatt*) gave a more detailed analysis of the same resin; it melts at 165° F. leaving 3.9 per cent. of ash. It is almost insoluble in alcohol, potash, ammonia, but dissolves completely in sulphuric acid and in fatty oils. Kauri contains the following percentages of the following five different resins: 13.5 of dammaryl soluble in ether; 24.5 of resin  $\alpha$  soluble in the hot in dilute alcohol but not precipitated on cooling; 10.5 of resin  $\beta$  soluble in hot dilute alcohol but precipitated on cooling; 44.0 of resin  $\gamma$  of an acid nature dammarylic acid soluble in absolute alcohol; 7.5 of resin  $\epsilon$ , the residue after separating the foregoing.

Kauri yields distillation products. So far back as 1843 Thompson extracted from New Zealand Kauri a volatile oil which he called dammarol, containing carbon 82.2, hydrogen 11.1 per cent.

More recently, in 1881, Rennie, according to M. P. Muir, again took up the examination of this resin. He distilled the product in a rapid current of steam in a copper vessel. The distillation was continued until a semi-solid product appeared in the condenser; with 5.595 kilogrammes 750 cc. of oil were collected. The oil was separated from the water and fractionally distilled. After successive rectifications a colourless oil of density 0.863 at 18° C. was obtained, boiling between 157° and 158°, the odour and composition of which is that of terebene  $C_{10}H_{16}$ .

According to Wallach and Rheindorff, the dry distillation of Kauri gives a thick fluorescent oil, from which it is easy, by means of steam, to obtain a mobile oil. The yield of this is 22 per cent. of the weight of the copal, and it contains about 25 per cent. of pinene, much dipentene, a body similar to isoprene, and a substance containing oxygen.

Tschirsch and Mederstat examined recent Bush Kauri copal from New Zealand free from the outer weathered crust. The colour of the very irregular-shaped lump varied between amber yellow and brown. The fracture was conchoidal, lustrous; the smell intensely balsamic; the melting-point of the sample, dried over sulphuric acid, lay between 110° and 175° C. It was completely soluble in 80 per cent. chloral hydrate, alcohol, ether, acetic ether; it also dissolved partially in petroleum ether, chloroform, toluol, acetone and carbon tetrachloride. It was only slightly soluble in caustic soda and

caustic potash. Acid value, (a) direct, 103·6-106·4, (b) indirect, 106·4-112·0; saponification value, (a) cold, 112-117·6, (b) hot, 112-117·6. There is thus no real distinction between the acid value and the saponification value. By extraordinary slowly conducted dry distillation, the operation occupying eighteen days, no succinic acid was obtained. By repeated extraction of the copal with hot water a bitter principle was separated. Two kilogrammes of Kauri Bush copal were dissolved in ether and the ethereal solution was successively extracted by shaking with 1 per cent. solutions of (a) ammonium carbonate, (b) sodium carbonate, and (c) potassium hydrate. The ethereal solution contained after the three above extractions a body unaffected by potash and an essential oil which could be volatilised by steam. (1) The ammonium carbonate extract was neutralised by hydrochloric acid, and the resulting acid crystallised from ethyl-methyl alcohol. After twelve repeated crystallisations, a crystalline acid was obtained melting exactly at 192° C. This acid was termed Kaurinic. It dissolved in the usual resin solvents but very slightly in petroleum ether. The alcoholic solution reacted strongly acid and gave an optical rotation of +51·66°. The mean of four analyses gave C=71·95, H=9·25. Calculated for  $C_{10}H_{16}O_2$ , C=71·43, H=9·52 per cent. The molecular weight estimation gave, as a mean of six estimations, 170.  $C_{10}H_{16}O_2$  requires 168. Acid value, (a) direct, 330·4, (b) indirect, 333·2; saponification value, (a) cold, 331·8, (b) hot, 334·6. There is thus no true distinction between the acid and saponification values. Iodine value, 75·76. One gramme of the acid required 11·85 cc.  $n/2$  KHO=0·2310, K=23·10 per cent. K for the formation of the potassium salt.  $C_{10}H_{16}O_2$  requires for  $C_{10}H_{15}KO_2$  23·21 K. The acid is monobasic. One gramme acid absorbed 59·65 cc. iodine. One atom of iodine was added. The potassium salt was prepared by dissolving the acid in dilute KHO. Con. KHO separates it quantitatively and it may be crystallised from ethyl alcohol. It was thus got in needles. The salt contained 18·9 per cent. K.  $C_{10}H_{15}KO_2$  requires 18·93 K. The lead salt of the acid was prepared by precipitation with an alcoholic solution of lead acetate. The salt contained 38·1 per cent. Pb.  $(C_{10}H_{15}O_2)_2$ ; Pb requires 38·03 per cent. (2) The largest proportion of the resin acids dissolve in soda 40 to 50 per cent. of the resin. In dissolving the solution 146 shakings were necessary. Lead acetate resolves the extracted acid substance into two acids: (a) Kaurolic acid and (b) Kaurolic acid. The solutions of both acids react acid and are optically inactive. The acid precipitated by lead acetate intumesces at 75° C. and melts at 81-83° C. The acid not precipitated by lead acetate intumesces at 78° C. and melts between 85 and 87° C. Analysis gave (a) Kaurolic acid, mean of four analyses, C=73·41, H=10·14. Calculated for  $C_{12}H_{20}O_2$ , C=73·47, H=10·20; (b) Kaurolic acid, mean of four analyses, C=73·27, H=10·11 per cent. Acid value, (a) direct, 278·6-280, 277·2-280, (b) indirect 277·2-282·8, 277·2-282·8; saponification value, (a) cold, 278·6-280, 280-285·6, (b) hot, 280-282·8, 280-285·6. Kaurolic acid is a monobasic acid and adds one atom of iodine (64·43 per cent.).

(3) A 1 per cent. solution of caustic potash extracts 20-22 of the raw product; 116 shakings were given. The solution of the product thus obtained reacts neutral. It is resolved by lead acetate into two portions, one which gives a precipitate with lead acetate and one which gives no precipitate. The acid precipitated by lead acetate is termed Kaurinic acid. It dissolves in the usual solvents and in petroleum ether. It intumesces at 105° C. and melts between 128 and 130° C. Analysis gave, mean of four analyses, C=75.93, H=12.48. Calculated for  $C_{17}H_{34}O_2$ , C=75.56, H=12.59 per cent. It only gives an acid value and no saponification value, and forms a monobasic potassium salt. The portion not precipitated by lead acetate was termed Kauronic acid. It intumesces at 80° C. and melts at 86-89° C. The Kaureresene was not obtainable in a fit form for analysis; it constituted 12 per cent. of the resin and melted at 63° C. After the original ether extracts had been shaken up with the above three reagents, the ether was evaporated and the residue distilled at a steam heat. The distillate consisted of an essential oil of specific gravity 0.835 at 15.0 C. and boiling at 156-160°. The oil deposits a body in long fine needles crystallisable from dilute alcohol. It melts at 168° C. Analysis gave C=69.41, H=10.26. Found 69.23, H=10.26 per cent.

Bush copal (iodine value, mean of three analyses, 45.72) therefore consists of:—

|                                | Per cent. |
|--------------------------------|-----------|
| (1) Kaurinic acid . . . . .    | 1½        |
| (2) Kauronic acid . . . . .    | 40 to 50  |
| (3) Kaurinic acid . . . . .    | 20 to 22  |
| (4) Kaureresene . . . . .      | 12.2      |
| (5) Essential oil . . . . .    | 12.5      |
| (6) Bitter principle . . . . . | ½ to 1    |

New Caledonia possesses three species of *Dammara* which are actually important as sources of resin:—

1. *Dammara Lanceolata* (Lind.) (Fig. 10).—According to Pancher and Sebert this is a gigantic tree with a girth of 10 feet and height of 80 feet below the first branches. The cime is irregular, dense, the branches erect, forming an acute angle with the trunk. The branchlets are verticillate in fours, compressed flat. The bark is grey, smooth and exfoliated in wide slices. The leaves, 3 cm. by 7 cm., are opposite, sessile, long, lanceolated very slightly at the apex, lustrous on the upper surface with thick scarios edges; they are brittle with no midrib, the secondary veins barely visible, parallel or palmate, non-reticulated.

2. *Dammara Ovata* (Moore) (Fig. 11) is a tree generally of less height than the last, with persistent bark full of crevices. Its wide oval leaves are much shorter and thicker than those of *D. lanceolata*. The two species grow in the south of New Caledonia to a height varying between 800 and 4,000 feet in the slope of ravines in the humid gorges of the mountains; they frequent ferruginous soils rich in humus.

3. *Dammara Moorii* (Lindl.).—The Dicon of the natives, only grows in the north of the colony. It is a gigantic tree rising 80 to

120 feet with a straight trunk bare to a great part of its height with a girth of 5 feet. It is easily distinguished not only by its special habitat but also by its branches with blackish bark and glaucous leaves longer and narrower than those of *D. lanceolata*. They are  $13\frac{1}{2}$  cm. in length whilst their width rarely exceeds  $2\frac{1}{2}$  cm.

Of these three species the best known and the richest in resin is *D. lanceolata*. Formerly abundant this conifer tends more and more to disappear, for during the last thirty years it was destroyed in an alarming fashion. Formerly it constituted an immense forest in the neighbourhood of the Southern Bay, and important deposits of fossil resin attest its existence in that region. The names of Kauri



FIG. 10.—*Dammara Lanceolata*.

Bay, Kauri Woodyard, Kauri River recall how common these trees were in that district. But the deposits of fossil Kauri were pillaged and the Kauris felled. It is narrated that foreigners disembarked clandestinely and blew up with powder and dynamite everything which stood in the way of getting at the fossil product, and amongst these obstacles it is necessary to include the roots of living Kauris and the trees themselves. The result is that where a vast forest of precious conifers extended, barely 200 trees still subsist. But this was not all. The depredations which threatened the complete destruction of the Kauris assumed another guise. Liberated convicts became gum diggers, but as the occupation is laborious and unremunerative—the deposits of resin being less abundant than in New



Zealand—they bethought themselves of manufacturing this fossil resin straight ahead. They set about it in this way. Choosing the finest trees they dug away the soil from below the roots and made holes there about 3 feet in depth. They then incised the exposed roots deeply from below and carefully covered the cavities which became filled with a secretion of an abundant perfectly limpid resin. A month or two afterwards the pits were opened and the operators withdrew the blocks of resin having all the appearance of the fossil product. It is plain that the Kauri trees could not long stand drastic tapping of this nature. This barbarous method explains two points: the origin of fossil Kauri resin which flows from accidental wounds to the roots and not to the trunk, and the comparatively short time which the resinous exudation requires to become changed and acquire the physical and chemical properties of fossil Kauri. At the present time the working of the New Caledonian Kauris is done by adjudication and under Government surveillance. A check has thus been given to the vandalism of the gum diggers. Moreover, the

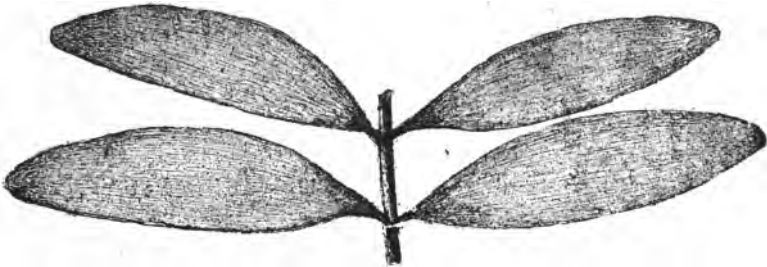

FIG. 11.—New Caledonian Kauri, *Dammara Ovata* (Moore). Part of a leaved branch.

Agricultural Department of the penitentiary administration has been engaged for several years in replanting the Kauri forests and has established nurseries with 60,000 plants. The propagation of these trees by seed is delicate. First of all, the seed to be sowed should be quite ripe; they should then be sowed as soon as possible, because they lose their germinative power very rapidly—a general failing of coniferæ, but more particularly with *Araucaria* and *Dammara*. The seed should be sowed in pots at the rate of a seed per pot. The seed is planted in soil rich in humus and in the ferruginous elements of which the *Dammara* are fond. The pots are interred in a moist soil in a fresh place, taking care that the water used to water the plants can get away freely. When the plants are 8 to 10 inches high they are transplanted from the first pots into larger ones, taking great care not to bare the roots, an exposure which coniferæ cannot stand. The plants should not be transplanted to the ground until they are about 20 inches high. The fact may here be recalled that the *Dammara* thrive best in ferruginous clay on the slopes where water can in no case remain stagnant. They grow extremely slowly.

Nevertheless, they are useful trees which find a place in the re-forestation of colonies with a temperate climate. There exudes from the trunk of these conifers a white resin which becomes darker in colour as it ages. At first fluid it flows down the bark and concretes in long tears which agglomerate together forming voluminous stalactites. New Caledonian *Dammara*, like those of New Zealand, formerly yielded an abundant now fossil resin, the extensive deposits of which in New Zealand have already been referred to. Needless to say, the fossil sort is the one most esteemed in commerce. It is however possible by judicious tapping to bleed the Kauris and thus extract the resin without any great damage to the trees.

If a cross section be made of a branch of *D. lanceolata*, for example, and if it be examined under the microscope, it will be seen that the resin-secreting vessels are localised in the bark. From 28 to 30 of these vessels have been counted in the cortical layer of a branch 3 millimetres in diameter. They are seen neither in the liber nor the pith. For these reasons of an anatomical nature, the process of tapping adopted in New Caledonia by the Agricultural Department of the penitentiary administration appears to profit by the best conditions. The trees should be 35-40 cm. in girth. Incisions are made cutting through the whole of the bark as far as the sap wood. Each incision is in the form of a niche that is a quarter of a sphere the section of which is horizontal. The contents of the upper segments of the secreting vessels flow into these niches. The very fluid resin soon accumulates and concretes therein instead of flowing over the surface of the bark or the ground, and in so doing becomes charged with impurities. Numerous incisions are made on each tree during the dry season. The fine *D. lanceolata* of the Bay of Prony and the central mountain range thus, treated yield annually 10 kilogrammes (22 lb.) of Kauri, worth 1 to 1½ francs the kilogramme (say 5d. to 7½d. the lb.). The more valuable fossil resin fetches 6 francs the kilogramme (say 2s. 2d. the lb.). The fine sorts are amber coloured, transparent and limpid and capable of being turned and sculptured like yellow amber. The fossil Kauri resin of New Caledonia dissolves completely in three-fourths of its weight of 90 per cent. alcohol. It is completely soluble in ether and almost also soluble in spirits of turpentine. These properties differentiate New Caledonia from New Zealand Kauri, and render it almost the analogue of the aromatic dammar of Guibourt of the Celebes. Aromatic dammar is in fact entirely soluble in alcohol and ether, but it is slightly soluble in spirits of turpentine. It has been attempted to distil Kauri in New Caledonia. The experiments made by the Agricultural Department of the penal administration have resulted in the extraction from the resin of an essential oil with a smell of turpentine. According to Jeanneny, 10 kilogrammes of resin yield 350 grammes of oil, say 3·5 per cent. This again differentiates it from New Zealand Kauri, which we have seen yields 13 per cent. of essential oil.

The Kauri resin is mainly exported to Great Britain and

America. The annual exports have constantly increased during the last fifty years. Only 355 tons were exported in 1875, whilst during 1883, 1884 and 1885 over 6,000 tons were annually exported. In 1885 there were 81,000 cwt., valued at £210,000, imported into Britain. The trade with America is rather important, the price of the resin being subject to the fluctuations of the New York market. In 1887 the lowest prices were £43 and £60 the ton. Kauri resin figured in the general table of exportations of Auckland for £250,000 sterling. The average value of the exports is about £280,000.



FIG. 12.—*Agathis Australis*.

*The New Zealand Kauri Gum Industry.*—The existence of the Kauri gum deposits has been of great commercial value to New Zealand, and from the first record of their exploitation to the end of 1905, 266,165 tons, valued at £12,920,531, had been produced. The quantities and their respective values found during the past six years were: 1900, 10,159 tons (£622,293); 1901, 7,541 tons (£446,114); 1902, 7,430 tons (£450,223); 1903, 9,357 tons (£631,102); 1904, 9,203 tons (£501,817); 1905, 10,883 tons (£614,444). These figures show that during the last few years the deposits have yielded prolifically, the total for 1905 being the largest during the six years, although values have fluctuated considerably, especially during the

latter three years, the value of £67 per ton in 1903 having descended to the low level of £52 per ton in 1905. The value of the gum exported during the past six years was £3,212,993, or about one-twenty-fifth of the total value of New Zealand home products. Nearly the whole of the product is bought by the United Kingdom and the United States.

The solubility of Kauri in alcohol is diminished after it has been deprived of its essential oil. On the other hand, this resin is more freely soluble in its own essential oil than in spirits of turpentine. Dr. Torné, chief medical officer in the French Navy, has utilised in surgery the perfect solubility of Kauri in its own essential oil. He has used this resinous solution advantageously in place of silicate of



FIG. 13.—*Dammara (Agathis) Australis*. Extremity of leaved branch ( $\frac{3}{4}$  natural size). Source of Kauri Gum.

potash to make the immovable apparatus used in the treatment of fractures. The easy way with which New Caledonian Kauri mixes with different vehicles gives it an important place amongst varnish resins. This fossil product like hard copal should be washed before being put on the market. Like copal Kauri should be carefully sorted according to colour. Packing for export requires the same care and precautions as for all resins.

In 1890 New Caledonia exported to foreign countries 2,800 kilogrammes (rather under 3 tons) of Kauri resin, a very minimum quantity compared with the New Zealand and Malay archipelago trade. In 1895 samples were sent to the United States, were much appreciated, and led to requests for information and offers to buy.

## MANILLA COPAL.

Livache divides Manilla copals into those with a slight Kauri character, and soft Manilla of a pale yellow colour, resembling the Indian dammar of French commerce. According to Guibourt, *Dammar puti* or *Dammar batu* is the product of *Dammara orientalis*. It burns without fusing, has a horny turbid look, and is not made sticky by spirit. Even when powdered it will not dissolve completely in alcohol or ether. It is almost insoluble in oil of turpentine, and generally it resembles amber closely. Halphen describes Manilla copal under the title of *Dammar aromatique* (which Guibourt calls *Celebes Dammar*) thus: This common resin appears destined to play a great part in varnish manufacture. It has a glassy conchoidal fracture like animé, scratches with a knife with difficulty, and has



FIG. 14.—*Dammara Alba*, the possible source of Manilla Copal.

no taste beyond a slight but peculiar aromatic after-taste when chewed. It is for the most part soluble in alcohol. The *Dammar aromatique* differs from Kauri and animé in being completely soluble in ether, and almost insoluble in oil of turpentine. Manilla copal (Wiesner) is a collective term for medium-hard resins coming from Sumatra, Java, Borneo, Celebes, the Philippines (especially Luzon) and the Moluccas (Amboyna, Ternata, Batjan, etc.). Their properties point to a common origin. They also come on the market under other names, such as Borneo, Singapore, Philippine and Indian copal.

Most authorities on resins give the *Vateria indica sive malabarica*, an Indian dipterocarpous tree, as the source of this resin. But *V. indica* indigenous to the Indian continent from Canara on the Malabar coast to Travancore in Madras yields Piney resin, not Manilla copal, which comes from the Sunda Islands, the Moluccas, the Philippines, etc.

The authentic samples of the resin of *V. indica* in the now defunct Indian Museum of London all came from Madras, Mysore, Travancore, or other places on the continent of India. A German authority's researches into the origin of the true dammar of the European market have also made him acquainted with the origin of Manilla copal. During his stay in Java and Sumatra he had ample opportunity of observing *Dammara australis* and its products, and was able to recognise at once that its resin did not correspond to dammar, as we understand the latter in Europe. It was much more like Kauri than anything else in appearance, hardness and odour.

The distribution of *Dammara orientalis* corresponds fully with that of the ports of shipment of Manilla copal. The tree is indigenous to the East Indian archipelago, especially the Sunda Islands, the Moluccas and the Philippines, and does not occur on the mainland. It grows in vast numbers, and is one of the most prolific resin producers known. European dammar does not come from it, but it is highly possible that it is the source of Manilla copal. The resin flows from the trunk of the tree in great masses, and is often carried away in great lumps by the rivers, and found in rocky masses on the banks, whence the Malay name *Dammar batu* (Miquel). This *Dammar batu* has been regarded as the dammar of the European markets, but it is quite different therefrom. It is Manilla copal. *Batu* in Malay means rock or stone. *All samples of the resin of Dammara orientalis distinguish themselves sharply from commercial dammar by retaining, even after long storage, a powerful balsamic smell, much like that of turpentine.* Even after many years this smell is very distinct when the resin is rubbed with the hand.

Wiesner has shown that the Asiatic copals are not fossil, and that they are still being produced in large quantities. Nevertheless, really soft masses of them do not come on the market, although enclosures of liquid in the lumps are not uncommon.

The weathered surface of the lumps, some of which may weigh as much as about 90 lb. (Andès), is always much duller than the fresh fracture, but such a weathered crust as is to be found on African fossil copals and on Kauri is not to be found on Manilla copal. The surface of milky turbid sorts becomes by coagulation several shades darker in time, but this dark superficial crust becomes white by rubbing, and a quite thin white or yellowish crust often covers the natural resin and possibly owes its origin to the prolonged action of air and running water. Manilla copal is somewhat low down in Bottler's scale of hardness and is classified with the medium hard copals. It scratches gypsum and is about equal in hardness to rock salt. Manilla copal varies greatly in colour, from grey, brown and green to almost black. The same lump is often variegated and striped and banded like agate or cat's-eye. By lying in the air the milkiness is dissipated but the resin becomes darker. The milky appearance is shown under the microscope to be due to a large number of minute spherical or ellipsoid cavities charged with a

brown solution of resin in essential oil. The gradual evaporation of the essential oil induces the darkening, and the walls of the cavities coalesce until the whole mass becomes homogeneous and appears under the microscope as a colourless body permeated with yellow and brown spots. In some parts pieces of Manilla may appear quite clear, but a whole natural piece is never or very rarely found so. The lowest melting-point of Manilla copal is about  $103^{\circ}$  C., the highest about  $120^{\circ}$  C. The melting-point and the solubility vary greatly. Soft Manilla copal melts readily but contains much water difficult to get rid off. Such copals can, it is said, after fusion be mixed with boiled oil but not with turpentine. The harder Manillas fuse fairly readily and can be mixed after fusion with both turpentine and boiled oil, but such varnishes do not readily mix with pigments. The following sorts are to be found on the market: M. C. hard extra white, M. C. yellowish-red spirit soluble, M. C. blond hard extra fine, M. C. hard brown, M. C. white yellowish-red, M. C. yellow extra fine. The Manilla copals, according to Weisner, dissolve nearly entirely in the cold and completely with the aid of heat. Ether alone or aided by camphor dissolves the greater portion of the resin. But chloroform and methyl alcohol dissolve but little of the resin. But such generalisations as to the solubility of Manilla require profound qualification. The soft Manillas, the so-called "spirit soluble," do dissolve fairly readily but are apt to leave a grey gelatinous residue. But it is a frequent occurrence with the harder Manilla copals when agitated with spirit for the crushed resin to coalesce and segregate into a slimy gelatinous stringy mass which no amount of coaxing can bring into solution. Besides, if solution were effected by mixed solvents, the moment the user attempted to thin the varnish, unless supplied by the vendor with the mixed solvent for the purpose, the whole of the resin would fall out of solution as a gelatinous, intractable india-rubber-like mass. The resin and solvent together aid solution if the resin be tractable, but is little or no aid to bringing intractable resins into solution. Exposure to the air is said to aid solution. Epichlorhydrin and dichlorhydrin are good solvents for Manilla, but they are far too dear; besides, they make the solution very acid, so that it cannot be used for metals. Manilla copal can very readily be distinguished from real dammar: there is no resemblance between the two. Manilla resembles Kauri, whilst real dammar resembles, until handled and put in the mouth and between the teeth, very fine pieces of clear and transparent gum-arabic. Who could confuse such widely different products? Besides, oil of turpentine completely dissolves true dammar. It is almost without action on Manilla copal. In 80 per cent. chloral hydrate dammar swells but dissolves very little even after digestion therein for months. Epichlorhydrin dissolves Kauri very completely when hot and always better than it does dammar. Manilla dissolves nearly entirely in epichlorhydrin.

Tschirsch and Koch examined a sample of resin from *Dammar*

*Orientalis* obtained from Traine and Hauffs, copal washers of Mainz. The sample was marked "M. C. spirit-soluble," white dull. It was in irregular-sized yellowish-red transparent lumps of the size of a walnut with a faint smell, covered with a powder; fracture conchoidal, glassy. It was capable of being readily pulverised. The taste was aromatic, and when masticated it sticks to the teeth. The melting-point of the sample, dried over sulphuric acid, lies about  $115^{\circ}$  C. The sample dissolved clear in 80 per cent. chloral hydrate solution (it cannot then be a product of a *Vateria*, as no *Vateria* resin dissolves in chloral hydrate) and in alcohol. It was quite soluble in acetone, partially soluble in acetic ether, chloroform, toluol, benzol, acetic acid, methyl alcohol, slightly soluble in carbon tetrachloride and quite insoluble in petroleum ether. It dissolves in a little ether, but additional ether begets cloudiness. Acid value: direct, 134.4, indirect, 170.8-173.6; saponification value: cold, 190.4, hot, 187.6-190.4; iodine value, 55.37. Destructive distillation, conducted very slowly (occupying about ten days), gave for 100 grammes of the sample 2.0 grammes of a watery fluid at  $110^{\circ}$  C., 18 grammes at  $160-170^{\circ}$  C. of a pale yellow light fluid with an acid reaction, due to formic and acetic acids, 30 grammes at  $210^{\circ}$  C. of a reddish-brown neutral oil, 40 grammes at  $210-220^{\circ}$  C. of a deep brown thick fluorescent neutral oil, and 5 grammes at  $250^{\circ}$  C. of a substance solidifying in the neck of the retort. By extracting the pulverised copal with hot water a bitter principle is dissolved which gives a precipitate with lead acetate, tannin and iron chloride. The ethereal solution of the sample was shaken in succession with (a) 1 per cent. ammonium carbonate, (b) 1 per cent. sodium carbonate, and (c) 1 per cent. potassium hydrate.

According to Mr. Ingham Clarke there are no fossil resins that require more care and experience in the buying and using than Manilla copals. Some are so exceedingly soft that practically they are but little better than common rosin; others are so hard that great difficulty is experienced in melting them, while they all have some tricky characteristic, peculiar to their particular variety, which causes trouble to manufacturers who melt them, even months after the varnishes are made. The fact of the matter is, that Manilla copal strings, and it can be stripped off the object on which it is applied at a certain stage of the drying of the varnish in long dangling cords in the same way as the soft first year's bark can be stripped or flayed off a young branch of, say, a pine-tree. This property of Manilla copal is so characteristic as to lead to its detection in any varnish into which it enters. Rosin counteracts this tendency, and the one cheap resin can thus be so far used to mitigate to a certain extent the defect of the other.

#### WEST INDIAN ANIMÉ COPAL.

West Indian or American animé, Demerara animé, is the product of a Leguminosa, the *Hymenaea L.*, a tree 80-100 feet high, known as the locust-tree of British Guiana. The leaves are alternate,



bifoliated, coriaceous, shiny leaflets, oval, lanceolated, unsymmetrical at the base, with transparent dots. The pleasantly perfumed flowers are in terminal corymbiform clusters. The calyx is campanulate, with four or five pubescent caducous segments. The corolla is white with almost equal petals. There are ten free stamens. The ovary is stipitate, the style filiform, and the stigmata obtuse. The indehiscent reniform, brownish, hard, rugose (as if shagreened on the surface) pod is 10 to 15 cm. long by 5 to 6 cm. broad and 2 cm. thick, contains 3 to 5 ovoid seeds with a very hard tegument embedded in a yellow farinaceous pulp. The tree grows in Guiana, Venezuela, Brazil, Mexico and the West Indies. The resin flows from its trunk, its branches, and even its fruit. It is probably the Jutaicaica, used as a varnish in Brazil. This resin is regarded in commerce as a semi-hard copal. It was formerly termed by the French *Animé tendre*, but this term should be abolished as confusing it with Manilla, etc. The best sort is found fossil, and is met with embedded in the soil where it has lain for a greater or less length of time. A magnificent specimen is in Mr. Ingham Clarke's collection weighing about 60 lb. It has flown from fissures or accidental wounds on the root. It occurs as hard, more or less bulky, rounded, spheroid or ovoid nodules, of a dirty whitish or greyish aspect, as they are always covered by a thin friable oxidised layer. On removing this surface layer, or on breaking the piece, the perfectly limpid, brilliant, vitreous resin appears. The substance softens by heat and melts between 180-200° C., and heated to 230° C. decomposes, yielding a liquid distillate—copal oil. The only data in regard to the resin exuded from the tree itself are those, now old, of Laurent and Paoli. The results of their analyses are given in Gerhardt's *Organic Chemistry*, iii., p. 667. According to Paoli the resin may be resolved into two, the one soluble in cold alcohol, the other only in boiling alcohol. According to Laurent the resin soluble in boiling alcohol is deposited on cooling as light, acicular flakes. But the fruit is often covered with a coat of resin secreted by resiniferous pockets in the pericarp. The pericarp extracted by ether yields (a) 0.262 per cent. of a crystalline body, (b) 3.643 of resin melting at 172° C. It is soluble in alcohol, ether and carbon disulphide. It is found that this green resin, extracted from the pericarp by appropriate vehicles, contains three distinct products of different elementary composition and further characterised by different solubility in alcohol, ether and chloroform.

Heckel and Schagdenhauffen, the authors of the above research on the pericarp resin, comparing their results with those of Laurent and Paoli, conclude that the courbaril pod yields a resin with a valerianic odour quite different from the soft American animé yielded by the stem and branches of the same tree. Cordemoy, having recently at his disposal a rather large quantity of absolutely authentic fossil courbaril resin from Guiana, tested its behaviour with a certain number of solvents. His results were very different from those of Laurent and Paoli. He, on the other hand, found that there were great analogies

between the resin issuing from the pod and that exuded by the tree. He gives the following properties as characteristic of this resin: It is completely soluble in cold absolute alcohol, only partially so in chloroform and ether. Previously ground and then treated with chloroform it rapidly softens, forming a stringy, pasty mass floating on the liquid and only dissolving slightly therein. The solution separated by filtration and evaporated on the water bath, leaves on the bottom of the capsule a limed amber-yellow transparent resin with ether; solution also is only partial; the solution after filtration yields on evaporation an almost colourless vitreously limpid resin. The residue from the ether extraction dried in the water bath and taken up with chloroform only partially dissolved. The fresh residue, dried in its turn, rapidly dissolved in absolute alcohol. The resin extracted by alcohol is amber yellow like that obtained by chloroform. Summing up: The action of these different vehicles show that courbaril resin consists of three distinct resins, one soluble in chloroform, a second in ether, a third in absolute alcohol, which, moreover, dissolves the two preceding and their remainder, and is in fact the best solvent for this product. The three constituent resins are amorphous. It seems, therefore, that Laurent and Paoli made a mistake by working on a non-authentic sample, as is very possible with exotic products, and that their analyses were made on some other resin than that of courbaril. Their results seem to be confused with those from some species of protium. If we now compare the resin extracted from the fruit and examined by Heckel and Schagdenhauffen with the results obtained by Cordemoy in his examination of courbaril resin, it will be seen that the former consists of three products, all three soluble in chloroform, two of them in ether, one only in absolute alcohol. The solubilities of the latter are quite different. The best solvent for the former is chloroform, for the latter absolute alcohol. American animé yields paler but less durable varnishes than hard copal; they may be used advantageously for indoor work. Cordemoy points out this varnish may be put to another if much more restricted use. Obtained in the pure state by any of the vehicles indicated, its solution in xylo may take the place of the classical Canada balsam in the mounting of microscopical preparations. These preparations, treated by colouring reagents of current use in vegetable micrography, are very well preserved in this liquid, and maintained a sharpness of definition which leaves nothing to be desired.

C. Coffignier (*Bull. Soc. Chim.*, 1906, 35, 1143-1150) gives the analysis of three samples of American copals and their solubility in various menstrua. The figures obtained are as follows:—

TABLE XIV.—CHEMICAL AND PHYSICAL CONSTANTS AND SOLUBILITY OF DEMERARA, COLUMBIAN AND BRAZILIAN COPALS.

|                                | Demerara. | Columbia.     | Brazil.   |
|--------------------------------|-----------|---------------|-----------|
| Sp. gr. at 19° C. . . . .      | 1·047     | 1·054         | 1·053     |
| Melting-point . . . . .        | 180° C.   | above 300° C. | 100° C.   |
| Acid value . . . . .           | 97·7      | 118·8         | 123·0     |
| Saponification value . . . . . | 102·4     | 155·7         | 133·3     |
| Solubility in—                 |           |               |           |
|                                | Per cent. | Per cent.     | Per cent. |
| Ethyl alcohol . . . . .        | 27·9      | 33·0          | 69·8      |
| Methyl alcohol . . . . .       | 22·6      | 40·0          | 50·0      |
| Amyl alcohol . . . . .         | 47·0      | 95·1          | 98·2      |
| Ether . . . . .                | 44·6      | 50·0          | 70·3      |
| Chloroform . . . . .           | 43·1      | 45·3          | 64·0      |
| Benzene . . . . .              | 29·1      | 39·2          | 59·5      |
| Acetone . . . . .              | 30·8      | 56·4          | 62·4      |
| Oil of turpentine . . . . .    | 7·5       | 31·3          | 51·8      |
| Benzaldehyde . . . . .         | 49·8      | 81·7          | 73·3      |
| Aniline . . . . .              | 26·1      | 97·8          | 91·7      |
| Amyl acetate . . . . .         | 62·9      | 94·0          | 96·6      |
| Carbon tetrachloride . . . . . | 24·5      | 30·4          | 55·1      |

These are, no doubt, soft copals, similar to the Demerara copal, the product of the locust-tree (*Hymenaea courbaril*). The Demerara copal evolves a distinct odour of valeric acid when it is powdered. It is easily distinguished from Madagascar copal by the difference of its solubility in aniline.

*Valuation of West Indian Animé for Varnish-making.*—The second sort of gum copal imported from South America is in appearance somewhat like the African but much larger, and to those who are not good judges appears far the best, although in reality not worth one-third the value of African, as after all the labour of scraping, picking, etc., it is in general so full of acid and sap that not above two-thirds of it is fusible, and perhaps in many instances not more than one-third, and some whole casks are imported not worth one farthing; however, by proper judgment and long experience there may at times be found passable samples which may serve for very cheap varnishes. The third sort of copal is never imported by itself but is found mixed amongst the gum animé. It is very large, pale, hard, transparent, and fuses well and fixes well and makes excellent varnish.

## CHAPTER V.

### RESINS—ASSORTING, CLEANING AND FUSING.

*Cleaning and Garbling Resins.*—The cleansing and preparation of resins—copals in particular—is a point of great importance, looking to the quality of the varnish into the composition of which the resins will subsequently enter. This preparation generally includes (1) sorting out of the lumps or pieces, according to their size; (2) washing; (3) sorting out according to quality; and (4) crushing.

*Copals.*—It is customary to separate these into five kinds, using sieves of previously determined dimensions. The meshes of the sieves in general are one square centimetre in section, then four meshes per square centimetre, and finally twenty-four meshes per square centimetre. They are thus obtained: (1) The large pieces sorted out by hand; (2) the pieces having more than 10 millimetres in diameter; (3) the pieces having more than 4 millimetres in diameter; (4) the pieces having more than 0.4 millimetres in diameter; (5) dust. Generally only the sorts 1, 2 and 3 are washed, because too great a loss would occur if it were attempted to wash the kind No. 4. Each batch washed consists of pieces of gum resin of the same size, because different sized pieces are unequally attacked by the cleansing agent. Finally, and more generally, only the hard copals are washed, particularly Angola, Benguela, Sierra Leone and Congo copals, and sometimes Manilla.

The washing lye, a weak solution of caustic soda or of carbonate of soda, attacks the outer crust of the resins so that it may be removed by scrubbing. The resins are steeped for an hour in a wooden vat filled with water to which one gallon of a 5 per cent. solution of caustic or carbonate of soda lye has been added for every twenty gallons of water, after which they are passed through a washer fitted with brushes revolving in an alkaline liquid of the same strength. The time depends on the size of the lumps and the variety of copal. It is best to remove all the persistent specks by hand, either with a brush or a sharp-pointed knife, than to unduly prolong the action of the alkaline lye. The process is finished by several washings in pure water and the washed pieces laid out to drain or centrifuged and dried upon cloths, taking care that they do not touch each other. They are afterwards completely dried

either in the air or in a warm room. After washing, the pieces are sorted out according to quality. The larger pieces are broken up into medium-sized ones with a hammer, and they are then sorted out according to their colour. The smaller kinds are sorted according to their outside colour. Besides colour, purity must be taken into account, and those pieces which contain extraneous matter, such as vegetable débris, should be put upon one side. The latter is very apt to char when the copal is being "run," and thus by darkening the colour these vegetable remains diminish the value of the varnish. Hard copals are sorted out in this way into two or

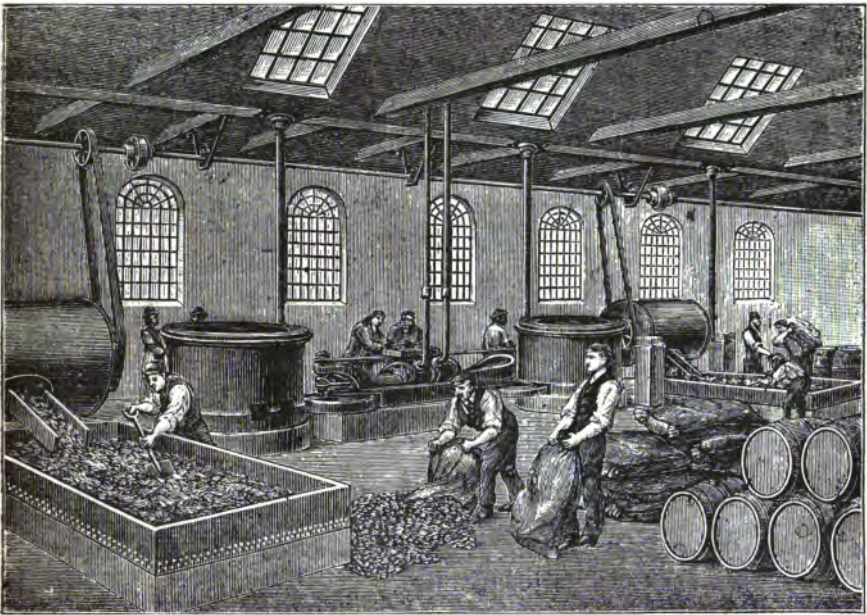

FIG. 15.—"Gum" Washing.

three qualities, and four, five, and even more qualities in the case of soft copals.

The lumps of which each lot is composed are now crushed or broken up, and this should be done methodically, because the size of the fragments is of great importance when the copal comes to be heated. The size varies with the hardness, and it is customary to break up the pieces into the following sizes, *viz.* :—

- $\frac{1}{2}$  cc. in bulk for East African (Zanzibar) copal.
- $\frac{3}{4}$  cc. in bulk for West African (Congo) copal.
- $1\frac{1}{2}$  cc. in bulk for soft copals (Manilla).

The crushing or grinding should be done in such a manner as to produce as little dust as possible, because the dust darkens when

heated. Even when but slightly heated, the dust agglutinates together and afterwards requires a higher temperature to dissolve it. When it is heated more strongly the particles of dust in contact with the sides of the vessel carbonise and colour the whole mass. For this reason breaking up should not be done with the hammer, because it pulverises, nor with an ordinary leverage cracker which produces powder and numerous splinters.

The most simple method consists in using a cracker analogous to that used for breaking loaf-sugar into lumps—one arm is fixed to the table and the other, provided with a long handle, is free; great leverage is thus obtained, and the lumps have not far to fall on to the table.

Machines have been made which will break  $2\frac{1}{2}$  to 3 tons a day, yielding a percentage of dust varying from 8 to 10 per cent., according to the kind of copal. They also grade the copal into different sizes. If the copals are not to be fused but simply treated by a solvent, they are not crushed but pulverised straight away. The powder produced in crushing is also reserved for treatment in the cold by solvents. The copal mill shown grinds by means of revolving

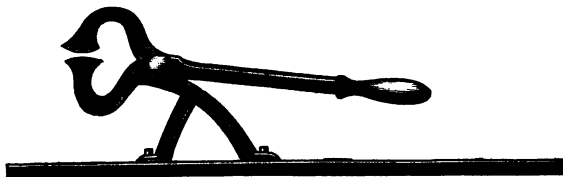

FIG. 16.—Gum "Cracker".

discs, with triangular teeth on their circumference; the distance between them is adjusted according to what size it is desired the pieces should have. As resins are brittle, smaller pieces are produced than that for which the mill is adjusted, also dust. The ground product must therefore be sifted and screened.

From the appearance of the large pieces, their colour and their origin, the manufacturer knows fairly well what he may expect from any given lot of copal in regard to its behaviour with different solvents. But in the case of small pieces, and often with soft copals, they cannot be broken up for examination as to colour, purity, etc. In that case a fair average sample is taken and melted at as low a temperature as possible, and the necessary trials are made upon the mass thus obtained to ascertain how the bulk will behave.

*Method of Crushing Varnish Resins on the Small Scale.*—After having procured the necessary gums and sorted them as before directed, procure a board about the size of a large tea-tray and fix on to it a back and two ends, leaving it open at front; procure also a piece of lead 8 inches long by 6 inches broad and 2 inches thick; place the lead on the wooden tray, fill one end of the tray with the assorted gum which requires breaking; procure likewise a small hammer with

the end reversing the proper face of the hammer steeled and ground quite sharp; sit down, and with the left hand drag to one side every piece of gum that does not require to be broken, but lay every piece above the size of a filbert on the piece of lead and, holding the gum flat and steady between the forefinger and thumb of the left hand, hit with the hammer in the right the piece of gum one steady stroke and cut it piece by piece into the size of common filberts. Recollect during the process of breaking gum to cut out all the black, dirty or watery pieces as they come to hand, and lay them aside to be used with similar sorts.

*Effect of Partial Dry Distillation on Solubility of Hard Resins.*—The harder the resin, provided it dissolves in an unaltered condition in the solvent, the harder and brighter is the varnish; but hard resins

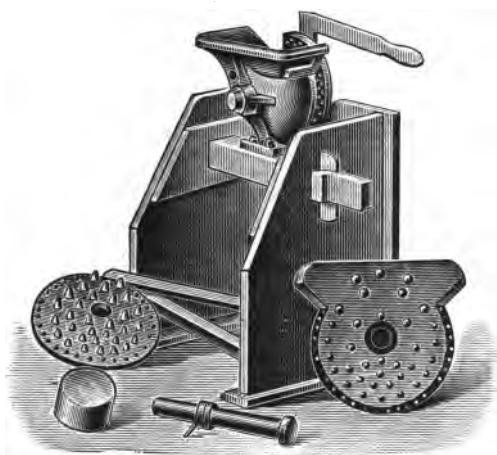

FIG. 17.—Varnish "Gum" Crusher.

(amber copal) are practically insoluble in the usual solvents, *e.g.*, methylated spirits, spirits of turpentine, linseed oil. Practical processes for dissolving hard resins in an unaltered condition without losing any of their properties, hardness, colour, etc., however desirable, are as yet unknown. By grinding them under water and then leaving them in the state of impalpable powder, for sometimes more than a year, Sochnee Bros. succeeded in dissolving them in 90 per cent. alcohol O.P. But this process is evidently unsuited for factories working continuously. The addition of soft resins does not increase the solubility of hard resins. Even if it did it would deteriorate the quality. Again, mixed solvents, *e.g.*, 1 lb. each of carbon disulphide, spirits of turpentine and benzol left in contact with 1 lb. of resin for several days in a closed vessel, have been tried, but on decanting the liquid it is rarely that complete solution is obtained. The best results are got by previously partially dry distilling the resin. Residual resins are thus obtained which dissolve completely in the usual sol-

vents. Riban's explanation is that the less a resin is polymerised the more soluble it is. The results of the dry distillation of resins led him to apply the preceding theory to the transformation of insoluble resins into soluble ones.

On the other hand, the changes effected in copal under the influence of heat were systematically studied by Schwarz, and his experiments, conducted with much care, are very interesting. Schwarz took a very fine specimen of raw copal, colourless, transparent and limpid, and dried for a long time over sulphuric acid, and placed it in ether where it swelled. By a series of experiments he found that 66 per cent. of the raw copal swelled and gelatinised without dissolving in ether. This copal, which he called *swollen copal*, and which on drying became converted into a horny mass, had always the same

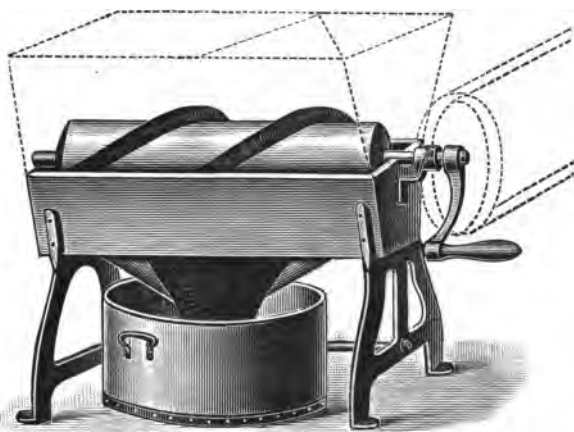

FIG. 18.—Varnish "Gum" Sifting Machine.

composition, swelling in solvents without dissolving. He then heated this swollen copal to fusion, and found that it now dissolved in the usual solvents. He called it *soluble copal*. On the other hand, raw copal was heated in the same way. He thus obtained a further product, *viz.*, *pyrocopal*, which dissolves in solvents, but the addition of alcohol to a solution, say in chloroform, precipitates a gelatinous product which he called *swollen pyrocopal*, whilst the product remaining in solution in spite of the addition of alcohol he termed *soluble pyrocopal*. Now the analysis of these different substances yielded the following results:—

TABLE XV.—SHOWING ANALYSES OF RAW, SWOLLEN AND SOLUBLE COPALS AND PYROCOPALS.

|                | RAW COPAL. |                                       | SWOLLEN COPAL. |                                       | SOLUBLE COPAL. |                                       |
|----------------|------------|---------------------------------------|----------------|---------------------------------------|----------------|---------------------------------------|
|                | Found.     | Calculated for<br>$C_{19}H_{30}O_2$ . | Found.         | Calculated for<br>$C_{28}H_{40}O_4$ . | Found.         | Calculated for<br>$C_{28}H_{38}O_4$ . |
| Carbon . . .   | 78.72      | 78.62                                 | 79.95          | 80.44                                 | 78.00          | 78.26                                 |
| Hydrogen . . . | 10.24      | 10.34                                 | 10.87          | 10.75                                 | 10.30          | 10.40                                 |
| Oxygen . . .   | 11.04      | 11.04                                 | 9.18           | 8.81                                  | 11.70          | 11.16                                 |



|                | PYROCOPAL. |                                       | SWOLLEN PYROCOPAL. |                                       | SOLUBLE PYROCOPAL. |                                       |
|----------------|------------|---------------------------------------|--------------------|---------------------------------------|--------------------|---------------------------------------|
|                | Found.     | Calculated for<br>$C_{19}H_{26}O_2$ . | Found.             | Calculated for<br>$C_{48}H_{54}O_3$ . | Found.             | Calculated for<br>$C_{36}H_{54}O_3$ . |
| Carbon . . .   | 83.63      | 83.82                                 | 83.01              | 83.23                                 | 81.02              | 80.89                                 |
| Hydrogen . . . | 10.36      | 10.29                                 | 10.52              | 10.69                                 | 10.37              | 10.01                                 |
| Oxygen . . .   | 6.01       | 5.83                                  | 6.47               | 6.08                                  | 8.61               | 9.10                                  |

Without attaching too much importance to the formula, it will be observed that the percentage of carbon is increased in every case by the action of heat. The change in composition arises at first from a loss in the elements of water, and finally at a higher temperature from a disengagement of hydrogen, carbonic oxide, carbonic acid, and

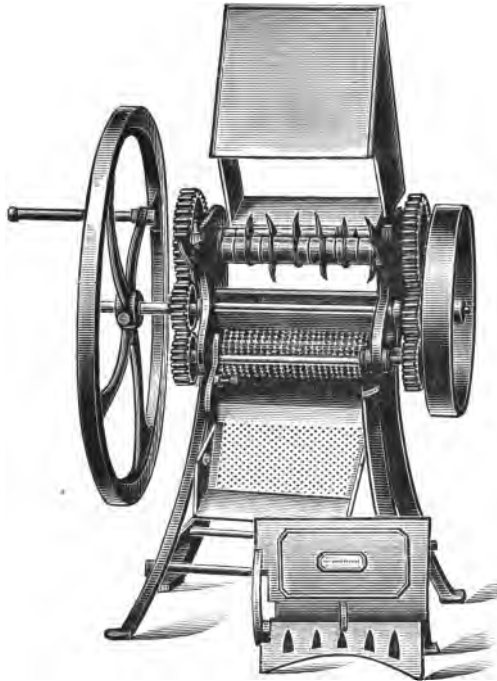

FIG. 19.—Varnish "Gum" Crusher (another form).

at last the volatilisation either of essential oils or the products of their decomposition. It is to the product which has been subjected to these changes that Riban's theory applies. If the heat applied be limited to the simple fusion of the hard resins, they do not dissolve in spirits of turpentine, neither in the hot nor in the cold. If the temperature be increased the quantity of soluble resin increases, but in order to effect complete solution the heat applied must be of such intensity and duration as to cause a partial decomposition of the resin, by which it loses about 25 per cent. of its weight. The greater the loss by distillation the more easily are the hard resins dissolved, but on the other hand, the darker in colour is the resultant varnish,

and the more unprofitable is the process from the manufacturing point of view. Moreover, it must not be forgotten that the resins alter more and more in proportion as the distilled product increases; they become soft and pitchy, and do not yield solid, durable varnishes, but varnishes which are dry, soft and tacky. The best process consists in working at as low a temperature as possible. Hard copal melts at 315-340° C., and distils about 360° C.; amber melts at 287° C. and distils at 320° C.; medium hard copal melts at 180° C. and distils at 230° C.

Of the many and varied ways of roasting and fusing copal the following is unique in its way, but more interesting in throwing a light on the nature of copal than it is capable of adoption in actual practice.

*Roasting Copal so as to Render it more Readily Soluble.*—Certain copals, says Schweizer, become soluble after an exposure of three or four days (*sic*) to a high temperature, 180° C. (356° F.). The process applies alike to small pieces and dust, but must be carried out in non-metallic vessels so as not to darken the resin. The most suitable vessels are large, very shallow trays of earthenware or porcelain, or enamelled iron in which there is no risk of the resin touching the metal. The plant required must be one in which a temperature of 180-200° C. (356-392° F.) can be maintained for any length of time. If the heat can be brought to 300° C. the plant will also in the same way roast amber with the same object in view. In construction the plant resembles an enameller's muffle furnace, consisting of a masonry or brickwork chamber with a thick earthenware floor underneath which is the coke fire. There is an aperture in the floor at the point farthest from the grate. Through this aperture the furnace gases enter the chamber and after following an almost circuitous path escape up the chimney. A damper near the outlet regulates the fire draught and the heat in the chamber. The chamber contains a car of thick iron plate on wheels, occupying almost the whole space so that the sides of the car are only a few inches from the walls, and the car is therefore continually surrounded by the hot furnace gases. This car, fitted with an air-tight door, rests on four wheels running on rails so that it can readily be pulled out of the chamber. Another door luted with clay inside closes the other end of the chamber to collect the volatile products. The pipe leading from the box can be screwed on to the end of a condensing worm. The interior of the case is fitted with strong wire shelves on which rest the vessels containing the resin. To economise space square shallow vessels are used, and the layer of copal in each is about 1 or 2 inches in depth. The layer must not be too deep as the copal dust has a tendency to cake and thus delay the process, but a deeper layer may be used if the copal dust be mixed with about its own weight of clean silver sand, which does not affect the copal whilst it keeps it porous. When the copal is dissolved the sand can be filtered off and used over again. To regulate the temperature of the box an electrical thermometer is fitted to the centre of it which rings a bell as soon as the heat has reached a

certain point. When the bell rings the damper must be quickly lowered to stop the heat rising further. It is a common thermometer with open top end through which a platinum wire almost fitting the bore is inserted. Another platinum wire in contact with the mercury is fused into the bulb. To use the thermometer the top wire is adjusted so that its lower end is opposite the degree not to be exceeded, say 200° C. (392° F.). One wire goes to the - pole the other to the + pole of a battery. Until the previously determined temperature is reached the circuit remains incomplete, but as soon as the mercury touches the top wire the circuit is complete. The bell rings and goes on ringing until the temperature falls so far that the mercury leaves such a gap between itself and the top wire as is sufficient to break the circuit. The car, filled with copal-charged trays and its doors luted, is run into the chamber. The chamber closed and luted, a good fire is lit, as it takes some time to heat up the chamber and the car. The fire is maintained until the bell rings, when the damper is nearly closed and the fire kept as high as may be without ringing the bell. The tube leads to a condensing worm where a small amount of distillate is collected never more than 2 to 2½ per cent. of the weight of the copal. It consists of pure water, and so long as that is so the heat has not been excessive or the distillate would have contained copal oil from the dry distillation of the resin. The insolubility of the copal might thus be attributed to its containing water. But experiments show that roasting acts on the copal otherwise than by merely drying it. By drying copal *in vacuo* over sulphuric acid after a few weeks the copal loses several per cent. in weight and the sulphuric acid has increased in weight correspondingly. The loss is due to the evaporation of the water from the copal and the gain to its absorption by the acid. Every trace of water is extracted from the resin, yet its solubility is not increased. The roasting causes a molecular change in the copal which increases its solubility.

*Distillation of Copal in the Roasting Furnace.*—The kiln and plant for roasting the copal can be used to partially distil the resin by heating it so that after the water comes over a yellowish oil floats upon the water. This oil consists of the dry distillation products of the resin. The fire is then regulated so that the oil distils over uniformly and the distillation is carried on until the requisite amount of oil has passed over. So that the iron box and the shelves in it may not be attacked by the copal fumes in such a way as to darken the copal oil itself, it is well to previously varnish the whole of the interior with the best thick amber varnish before the box is used for the first time. This permanently protects the iron from the fumes. As a somewhat high temperature is necessary to fuse and partially distil copal, and a still higher one for amber, say up to 400° C. for amber, the box must be made with care from boiler plate and riveted hot. But the advantages of such a process, if any, are only on paper.

*Rational Working.*—In subjecting copal or amber to partial dry distillation so as to render it soluble, care must be taken not to go

too far, otherwise a loss of resin will occur for which neither the corresponding amount of copal oil or amber oil will compensate. Different copals require different length of treatment in this respect. A larger proportion of oil must be distilled from hard copals than from soft copals before an easily soluble product is obtained.

It is necessary to cause the following resins to lose by heat the under-mentioned weights before they become soluble :—

TABLE XVI.—LOSS OF WEIGHT WHICH COPALS UNDERGO BY DESTRUCTIVE DISTILLATION BEFORE THEY BECOME SOLUBLE (LEPERT).

|                              | Per cent.    |
|------------------------------|--------------|
| Manilla, hard dust . . . . . | 11·7 to 13·3 |
| „ lumps . . . . .            | 14·6 „ 15·8  |
| „ . . . . .                  | 12·3 „ 16·5  |
| Angola, red, crude . . . . . | 21·6 „ 16·6  |
| „ washed . . . . .           | 16·6         |
| Sierra Leone . . . . .       | 17·2         |
| Zanzibar . . . . .           | 32·0         |
| Amber . . . . .              | 30·0         |

There is a limit which may be taken as common to all the sorts of copal. Most manufacturers consider that the loss of weight undergone by the copal should not exceed 25 per cent. As it is impossible to keep stopping the distillation to ascertain the loss the copal has undergone, some other means must be found of gauging the percentage lost. This is done by estimating the amount of oil in the distillate, and from this the condition of the copal in the still is inferred.

In conducting his experiments Violette employed a small glass retort to melt the copal, and heated it in a bath of molten tin at about 360° C., collecting the distilled products. The solubility was determined by keeping the resin and the solvent at 100° C. His results are given in the following table :—

TABLE XVII.—SOLUBILITY OF COPAL IN TURPS AS DESTRUCTIVE DISTILLATION PROCEEDS.

| Loss in weight by distillation.<br>Per cent. | Quantity of Oil resulting from the distillation. | Solubility of the heated Copal in Spirits of Turpentine. |
|--|--|--|
| 3·0  | 3·0  | Insoluble.   |
| 9·0  | 8·5  | „  |
| 10·5   | 10·2   | „  |
| 16·0   | 15·7   | „  |
| 20·0   | 19·0   | Slightly soluble.  |
| 22·0   | 21·3   | More easily soluble.                                     |
| 25·0   | 24·5   | Very easily soluble.                                     |
| 28·0   | 27·1   | „  |
| 30·0   | 29·0   | „  |
| 32·0   | 31·0   | „  |

If under ordinary conditions it is necessary to cause copal to lose 25 per cent. of its weight, Violette has, however, made the following interesting observation, which perhaps has not in actual practice received the attention it deserves. He has shown that copal, which has only lost about 10 per cent. of its weight and even less still, and which as we have seen is insoluble in ordinary spirits of turpentine, dissolves, on the other hand, very easily and completely in spirits of

turpentine which has been simply thickened by long exposure to light and air. It would appear to be easy by means of apparatus identical with those employed for the oxidation of drying oils to obtain such a product at a small cost, and the manufacture of copal varnishes would thus obtain lighter-coloured products, and at a less cost, in consequence of the smaller loss by distillation.

An examination of these figures shows that the yield of oil obtained is somewhat less than the loss of weight in the copal. The reason of this is that some of the products of the distillation consist of gases which escape into the atmosphere. The further the distillation is carried the greater the proportion of gaseous products. With a total loss of 25 per cent. (just the proper limit to make copal soluble) the loss in gas is only  $\frac{1}{2}$  per cent., while with a loss of 28 per cent. it is  $\frac{2}{10}$  per cent., and with one of 30 per cent. 1 per cent. We may now consider that we have made our copal sufficiently soluble when the weight of oil distilled over is one-quarter of that of the original resin. Beyond this limit it is useless to proceed, for thereby we duly diminish the yield of soluble product without securing any compensating advantage. To hit the point properly the same weight of copal or amber should always be taken for distillation, and the receiver should be of a corresponding size. This receiver must be graduated so that the amount of distillate in it will show at once how much of the resin has been decomposed. The best receiver is a tall glass cylinder graduated in the following way, assuming that 100 kilogrammes of copal are distilled at a time :—

Put exactly 800 grammes of water into the cylinder and mark the level of the water on the outside with a glazier's diamond. Then put in 800 grammes more and mark the new level in the same way, and proceed in the same way until 20 kilogrammes of water have been put into the receiver. Each division of the scale on the glass will then correspond with sufficient accuracy to 1 per cent. of the copal. The volatile oil produced by the distillation of the copal has a specific gravity of about 0·8, so that 1 per cent. of the 100 kilogrammes of copal, *viz.*, 1 kilogramme, corresponds to 800 grammes of water. For amber also, supposing a distillation of 100 kilogrammes at each batch, we proceed exactly in the same manner, but making the marks of the cylinder for 900 grammes of water instead of 800, as the specific gravity of the volatile oil in amber is 0·9.

*Fusion or Running Copal, etc., on the Larger Scale.*—Hard resins are decomposed by heating them either in open vessels or in plant provided with a condenser for the collection of the volatile products. The latter arrangement has the great drawback that the varnish-maker cannot follow the operation except by observing the quantity of condensed liquid. Now, the melting may be incomplete and the distilled liquid may come principally from the resin in contact with the most heated parts. Working with open vessels on the other hand, the quantity is in general smaller, and thus no difficulty is experienced in ascertaining when the whole is melted, but in the latter

process this point can only be accurately ascertained by weighing the receiver, which is but rarely done, the varnish-maker trusting more often to his experience.

In any case, preliminary laboratory experiments ought to be previously made upon the well-graded lots of resins which are to be converted into varnish. In the case of every new kind of resin a fair average sample should be taken of bulk and the amount of loss which it undergoes before a completely soluble product obtained is noted.

*Fusion in Open Vessels over a Naked Fire (Bartky's Method).*—According to Bartky, a cylindrical pot or pan may be used, having a diameter almost equal to its height, made of cast-iron, carefully enamelled and furnished with a tight-fitting lid, placed on a fire, and kept in position by a circular flange cast on to it about one-third of its height.

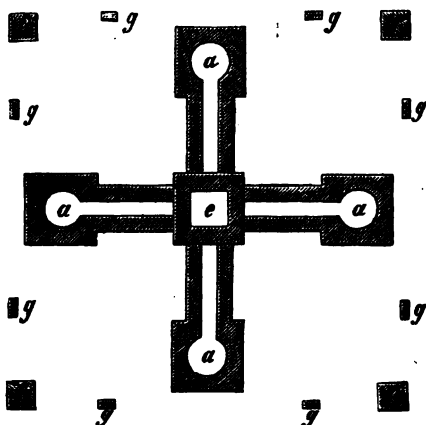

FIG. 20.—Ground Plan of Varnish Factory.  
a, furnace; e, chimney stalk; f, retaining walls of ventilators (see Fig. 21).

On the small scale, about five pounds of copal broken into pieces about the size of peas and freed from dust is fused. The *pieces* easily distil, whereas the *fine* copal is more refractory and yields dark varnishes. If the quantity of dust be considerable it is better to heat it separately. During the first five minutes the fire is carefully regulated at a moderate temperature, during the next ten it is more brisk, and it is afterwards maintained as much as possible at a temperature such that the melted copal does not froth up before half an hour has elapsed. The fire is now allowed to die down slightly, so that all the pieces of copal may be well melted; if this be not done certain pieces simply softened will be carried up by the froth of the melted pieces. As occasion may require the crust of the softened copal is broken by an iron rod, avoiding, however, any agitation of the mass beneath. When the whole mass

is melted the heat is increased in such a manner that the copal rises up two-thirds or three-fourths the height of the pan, then by lowering the fire the copal is allowed to fall down again to the bottom of the pot. Afterwards a stronger heat still is applied, avoiding, however, any overheat, but still sufficient that after two or three minutes the copal oil distilled begins to condense on the lid, which has been carefully adjusted on the pan, which is changed several times to prevent the copal oil from falling back into the pan. Finally, when abundant vapours begin to come off, the lid is taken away and a hood made to descend and surround the neck of the pan so as to carry the vapours outside, so that they neither spread through the room nor fall back into the pan.

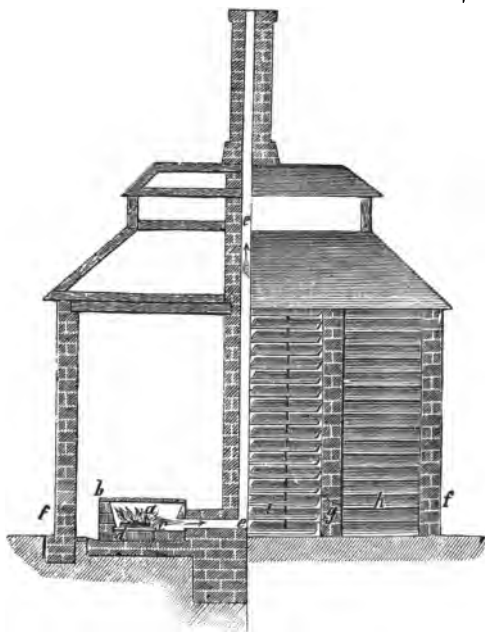

FIG. 21.—Varnish Factory Section and Elevation (see Fig. 20).

If it be desired to make pyro copal or pyro succin the pan is withdrawn from the fire when it is thought that a sufficient quantity has been distilled, and the whole is run into an iron basin which is covered, and allowed to cool.

According to Schwarz, who worked upon Zanzibar copal of first-class quality, the most suitable process consists in melting about 12 lb. at a time in a cylindrical copper vessel shaped like a large bottle with a flat bottom and capable of being closed by means of a tight-fitting lid. The mouth is fitted with a circular flange in the form of a gutter with a spout for running off the melted copal.

This vessel, being charged and fitted with its lid, is placed on

a simple brick furnace heated with wood charcoal, which has been carefully lighted throughout so that fusion may soon start with disengagement of abundant vapours. At this moment a movable flue is placed over the neck of the vessel which conducts the vapours to the outside. After fifteen to twenty minutes, and two or three agitations with an iron rod, the melted mass becomes clear and free from bubbles. It is then withdrawn from the fire, the cover is removed, and the vessel and contents allowed to cool a little, often at a gentle heat. The mass is then run into an iron basin; at any rate, as will be seen afterwards, it is not used immediately for varnish-making.

*Furnaces.*—The gum melting pots are placed upon either fixed or movable furnaces.

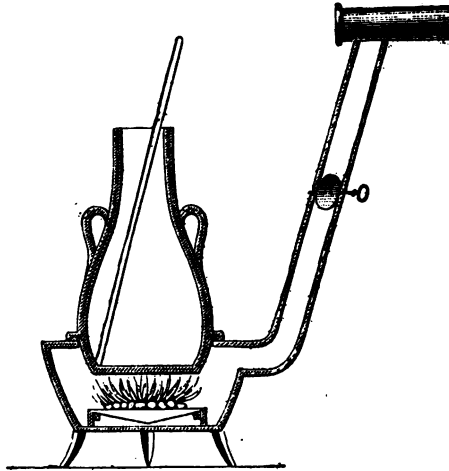

FIG. 22.—Movable Furnace.

The latter consist simply of a grate placed inside a sheet-iron covering supported on a tripod, with a pipe to carry away the smoke. They have the advantage of being placed anywhere, but they have the inconvenience of allowing great part of the heat to pass away by the flue, and thus cause an extravagant use of fuel. They are used, however, in small factories where the work is done in the open air. Coke or wood charcoal is the fuel generally used.

On the large scale, with continuous working, the furnaces are fixed and made of brick, and are arranged in a special building. Such furnaces preserve the same heat for a long time, and either coal or coke can be used as fuel. They, however, are inconvenient for the fusion of certain copals which froth much, especially Sierra Leone, which is profitable to work in spite of this deficiency on account of its relatively low price and good quality. In such cases the pan is placed in a basculed truck, by which it can be easily removed from the fire if the gum threatens to prime over.



*Gum Pots.*—The form given to these is very variable; when they bulge out they can be placed directly over the opening in the furnace, but it is preferable to furnish them with an iron ring, which enables them to rest solidly on the plate of the furnace, and which, measuring at least 2 inches in width, has the further advantage of cutting off all communication with the fire, and consequently diminishing the risk of fire.

*Cylindrical* pots are met with a diameter equal to about  $\frac{1}{3}$  of the height, made of cast-iron, carefully enamelled, and furnished with tight-fitting lids. But the weight is too great. They are therefore made of iron plate or copper. As the heat-conducting power of these materials is very great, the extent of the part of the pot

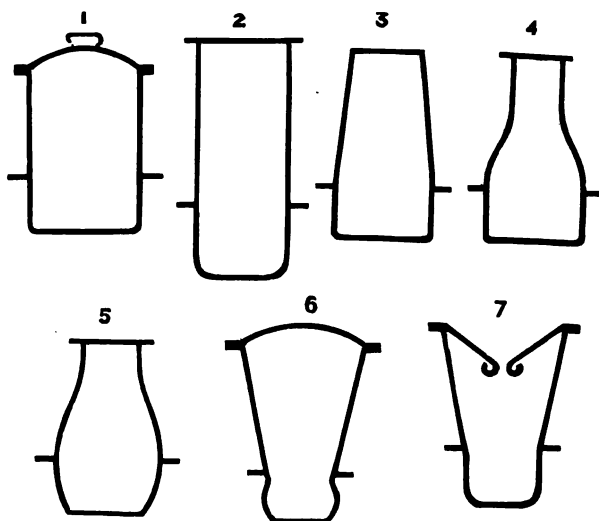

FIG. 23.—Various Shapes of Gum Pots (Livache).

which is directly heated is restricted, whilst at the same time the height is increased so as to prevent the copal suddenly rising and priming over.

Copper pots can only be used for varnishes the colour of which will not be affected by verdigris, which forms and colours the varnish, but copper has the advantage of being capable of being used in thin sheets, which impart lightness; further, they last a long time, and, as copper is a good conductor of heat, resins melt in such vessels very rapidly and evenly. For the manufacture of pale bright varnishes, pots made of wrought-iron and covered with a hard and resistant white enamel should be used.

Though the wrought-iron has the disadvantage of burning rapidly, and especially over a coal fire, on the other hand, it of itself imparts no colour to the varnish.

*Conical* pots have also been used, principally with the view of avoiding, as far as possible, the lowering of the interior temperature. To prevent the copal as it rises from plugging the restricted part of the pot, *bottle-shaped* pots have been designed. But this form has the disadvantage of allowing the disengaged vapours to condense too suddenly and fall back into the pot.

The expanded form obviates this inconvenience and prevents the copal from rising so rapidly and tumultuously, but each time the lid is opened, either for the purpose of stirring the mass or to

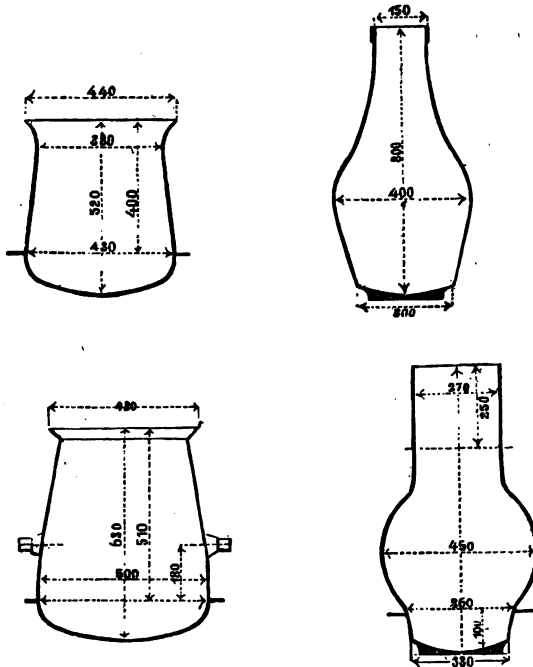

FIG. 24.—Designs of Gum Melting Pots after Andès. (The measurements are in millimetres.)

allow the vapours to escape, the interior temperature is lowered too soon and too suddenly.

A similarly shaped pot, provided with a lid in the form of an *inverted* cone, has lately come into vogue. The summit of the cone is sufficiently open to allow the passage of a stirring rod and the stirring of the resin. This shaped lid can—if need be—be used as a funnel in factories where varnish is made on the large and continuous scale. It may be objected that the distilled liquids condense on the surface of the lid and return to the centre of the pot, but as the lid is only on the pot during the time the distillation is not brisk, it is easy to adjust around the edge of the orifice an

annular gutter which retains the products first distilled and which condense readily, thus hindering them from falling back into the pot. We have incidentally spoken of the material which is used in the manufacture of gum melting pots. (a) *Enamelled iron pots*.—These have the disadvantage of cracking easily and conducting heat badly; further, the enamel is rapidly attacked and is soon partially eaten away. They may, moreover, be overheated. For these reasons only small quantities of copal can be fused in vessels constructed of this material, and even these often become darkened, and the value of the varnish depreciated. (b) *Copper pots*.—Thanks to the high conductivity for heat of copper, larger quantities of resin can be fused at a time and much more quickly without fearing any discoloration from the charring of the resin on contact with the hot sides. But, on the other hand, there is formed, as we have said, a coloration due to the formation of copper salts. There is

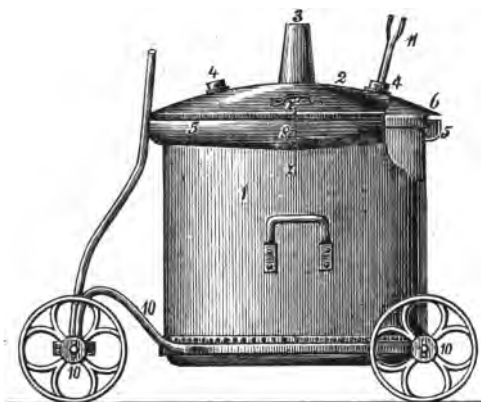

FIG. 25.—Varnish Kettle on Truck (Crockett).

observed a dull red cloudiness in copal fused in a copper pot, and this dulness is due to the presence of copper compounds formed by the action of the products of distillation on the neck and the lid of the pot. These green-coloured compounds fall back into the melted resin, and in consequence of a reducing action yield the ruby-red colour of copper. (c) *Silvered pots*.—In order to do away with this inconvenience, which diminishes appreciably the value of the varnish, Schwarz silvered the inside of the copper pots. He took a pot which had been in use, cleaned it well with acid, and silvered it with a mixture of nitrate of silver, cyanide of potassium and carbonate of lime. He found that under such conditions the melted copal was not coloured, only becoming very slightly dull red. With copper lined with silver the result was still better. (d) *Nickeled or galvanised copper pots*.—These might be used. Galvanised iron has been employed, it is said, with very good results. (e) *Wrought-iron pots*.—These are riveted and coated with an enamel. Copper pots are made of one

piece, at least as far as the bottom is concerned, which is then solidly adjusted and riveted to the top part; the latter is often made of sheet copper a little thinner than the lower part. The lower part of the pan should have no sharp angles, but should be slightly rounded, rather egg-shaped, so that it can be easily cleaned, without, however, affecting its stability when it stands on the ground. Many varnish-makers only clean their pots but very rarely, which is done with a little spirits of turpentine. By cleaning the pot after each operation there is no risk of leaving charred residues, or residues which may be easily charred, which would colour the gums afterwards fused in it. It would, therefore, appear to be advantageous to clean the pots carefully, and, if it be feared that the copper thus cleansed would colour the gum, the inside may be given a coat of oil varnish, which will diminish this risk.

Generally 25 lb. are operated on at a time in a copper still, silvered inside and built in masonry up to the capitulum. When it is not thought necessary to silver the inside, it is advisable to cover it with a coat of oil varnish. The coloration of the varnish with copper compounds is thus avoided, and this coating ought to be renewed each time that the alembic is cleaned.

A disengagement tube conducts into a chimney the fumes which escape condensation, but these are but very weak if the operation be well managed, and it is precisely by the quantity of products condensed that it is ascertained how far the distillation has been pushed. The condensed liquid, which on an average has a density of '800 for copal and of '900 for amber, is received in a vessel graduated according to the following data for 100 lb. of copal:—

|                                      |                 |
|--------------------------------------|-----------------|
| 10 per cent. of distilled products = | 8 lb. of water. |
| 11 " " " "                           | = 8.8 "         |
| 12 " " " "                           | = 9.6 "         |
| 13 " " " "                           | = 10.4 "        |

That is to say, that each one-hundredth part corresponds to '8 lb. of copal, and to '9 lb. of amber.

*Size.*—The depth of the pots should not be too great, it being necessary to reach the bottom with the hand when cleaning them. For easy working the dimensions generally are 2 feet to 2 feet 6 inches in height, with a capacity of from 4 to 5 gallons, and a weight of from 22 to 26 lb. In fact the size of the pot is proportional to the amount of gum to be fused in one operation. In America the cylindrical copper kettle taking 100 lb. of resin at a time is 36 inches wide and 36 inches in diameter all the way up and down, weighs when new about 130 lb. The riveted bottom wears out first. The rivet hole strip is then cut off and a new bottom put on, thus decreasing the depth until the whole pot is too thin and unsafe, when it is sold for old copper, weighing then about 80 lb.

*Condensation and Recovery of "Varnish Fumes" (Copal Oil).*—The processes suggested are numerous. Some, as will be seen, are obsolete. Others, if "up to date," are impracticable for several

reasons. Many appear to be mere whimsical drawings of the book draughtsman. But the ideas of book draughtsmen, if they behave well on paper, too often fail in actual practice.

1. *Tingry's Method Described.*—In a book published in 1816 under the title of *The Painter and Varnisher's Guide*, by Mr. P. F. Tingry, there appears the following article. It will be interesting to the trade to compare the past with present methods of manufacture. Tingry wrought by downward displacement of fused resin and fumes.

"The furnace, a section of which is represented in Fig. 26, may be entirely constructed of burnt clay, three large apertures being made in the lower chamber A, which supplies the place of an ash-hole in the common furnaces. The upper part of these apertures is arched; and the pillars or solid parts between them should be as narrow as possible, in order to enable the artist with facility to extract the liquefied matter, and even to mix it with the drying oil, if this kind of varnish be required.

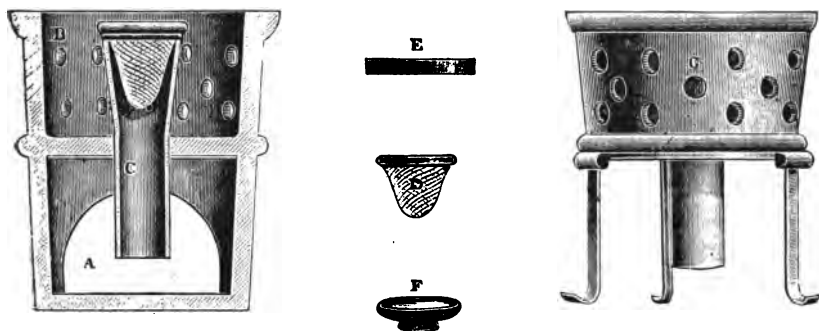

FIG. 26.—Tingry's Varnish-making Plant.

"The upper part B, or fireplace of the furnace, is separated from the lower part A by a bottom or plate, which answers the same purpose as a grate in the common furnaces. This plate has in the middle a circular aperture, the diameter of which corresponds to that of tube C, which it is designed to receive, and which extends a considerable way below it. This plate may either form one piece with the furnace, or may be movable. In the latter case, it is supported by three projections, or by a circular ledge, which projects inwards. In my furnace this partition is composed of an iron plate covered with a coating of potters' clay an inch in thickness. This precaution is indispensably necessary to prevent the heat from penetrating to the lower division A.

"The sides of the fireplace B are pierced with holes an inch in diameter, and distant from each other about 3 inches. These apertures admit air sufficient to maintain the heat at the degree proper for this kind of operation. The following are the proportions of the three parts of this furnace, which served me for my experiments, and

in which I liquefied six ounces of copal in the space of ten minutes, without altering its colour in a sensible manner:—

|  | Inches. |
|--|---------|
| Total height of the furnace . . . . .  | 17½     |
| Height of the lower chamber A, including the bottom, which was<br>an inch in thickness . . . . . | 11      |
| Height of the upper chamber B, or of the fireplace . . . . .                                     | 5½      |
| Diameter taken at the upper interior edge of the fireplace B . . . . .                           | 9½      |
| Diameter of the same taken at the bottom or partition . . . . .                                  | 7       |

“This part decreases in diameter 2½ inches tapering towards the lower part of furnace A. The tube C is conical at the upper extremity and cylindrical towards the bottom, it is 9½ inches in length, 4½ in diameter at the top and 2½ towards the middle. Both ends of it are open. The tube C is placed in the aperture formed in the middle of the partition in such a manner as to rise 3 or 4 inches into the fireplace. The place where it is joined to the partition is luted with clay to prevent the ashes or small coal from falling down. When this arrangement is made, the net D made of brass wire worked very open is placed in the tube. It has the shape of a funnel, the upper edge of which is made fast to a ring of the same diameter as the upper part of the tube C. The decrease in the diameter of the tube C conduces to the stability of this net, and the conical form of the latter prevents it from coming into contact with the lateral parts of the tube which is a matter of great importance to preserve the copal from too great alteration by the heat. The copal is placed on this metallic filter in pieces not larger than a small nut, and the whole is closed up with the iron plate or cover E, an inch in thickness, taking care to lute the joining with clay to prevent all communication with the exterior air. A shallow dish or capsule F filled with water is placed under the bottom of the tube C in such a manner that the tube is immersed in the water two or three times. The fireplace B being filled with burning coals so as to rise above the iron cover of the tube, the first impression of the heat on the copal is announced by a kind of crackling, the consequence of its dilatation which makes it split into small pieces. This noise is a sign of beginning liquefaction which indeed takes place soon after. A small iron pallet knife terminating in an elbow is introduced under the tube and moved in such a manner as to cause the liquefied part of the copal to fall down into the water and to bring it under the solid form towards the edge of the capsule. When the operation is finished the copal is spread out on dry linen cloths or on unsized paper to dry, it is then piled up and exposed to a gentle heat to deprive it of all its humidity. When the copal is falling down there is separated a very small portion of oil which remains fluid after the operation. It floats on the water as well as the copal, and gives to the latter a greasy appearance. But when the tube is of sufficient length there will be no necessity for immersing the end of it in the water, or even for receiving the matter in the water; but, in this case a kind of smoke will escape, which may be offensive to the artist.

The essential point is to regulate the fire in such a manner as not to alter the colour of the copal. If a very thick smoke issues through the lower aperture of the tube when red hot, and when the drops which fall into the water rise into bladders and burst, there is reason to conclude that the fire is too violent.

“I have succeeded in composing varnish with fat oil, in the same operation, by substituting drying oil in a state of ebullition for the water, and keeping it in that state by means of a mass of very hot iron, which served it as a supporter. The mixture of the liquefied matter is facilitated by means of a spatula, with a knee at the extremity, and the boiling oil of turpentine is afterwards added. The inconvenience of placing a volatile and highly inflammable oil under the apparatus may be readily conceived.

“I shall always insist more on the separate liquefaction of copal than on the possibility of completing the mixture of it with a drying oil, to form a varnish of the fifth genus. This new means enables the artist to compose a very durable and nearly colourless varnish, superior to copal varnish composed with drying oil, as the composition of the latter requires processes which alter the essential qualities of the substances that form the basis of it.

“For operations on a larger scale, the dimensions of the furnace may be changed; but in this case it will be proper to put the fire-place, properly so-called, on a kind of iron tripod, as represented at G, Fig. 26, in order that the workman may be more at his ease. I must, however, always insist on the advantage of employing not more than six ounces in one operation.

“The valuable advantages resulting from this new method will be perceived when a trial has been made of the varnish composed with oil of turpentine and copal melted by it. Copal thus prepared has properties different from, and more extensive than, those communicated to it by the common method; and it has not that dark brown colour which it acquires by too high a temperature and too long exposure to heat. In a word, it is impossible to prepare fat copal varnish possessing but little colour, but by making use of oil as little coloured as possible, such as that of poppy prepared in leaden vessels, according to Watin's method.

“In like manner also this copal, simply modified, may increase the solidity of spirituous varnish in a more direct manner than when it is employed without any preliminary preparation. A second liquefaction would perhaps give it the property of being soluble in spirit in greater quantity; but there would be reason to apprehend that the alteration in its principles, carried too far, would give it no superiority over those resins which are most soluble in that liquid.”

2. *Andres' Method.*—Andres used a condensing plant which on account of its simplicity may be of interest to manufacturers. It consists (Fig. 27) of a sheet-iron cylinder C well-riveted together, which terminates in the form of a cone, and which rests on a sheet-iron cylinder O acting as a furnace. In the annular central space a

second cylinder J of copper of less diameter is placed, the lower part of which, likewise conical, is pierced with small holes. Armatures maintain this interior cylinder in such a position as to leave a free space of  $\frac{2}{5}$  to  $\frac{3}{5}$  of an inch between the copper cylinder and the sheet-iron cylinder. The copal is placed in this copper cylinder J. After having shut the mouth of the cylinder with a well-luted lid D and brought the temperature to the melting-point of copal, the latter melts and runs away in drops, whilst at the same time a portion of the products of distillation condense in the conical part. The melted copal and the condensed products are received in a suitable vessel K which in the case of oil varnish may already contain the necessary

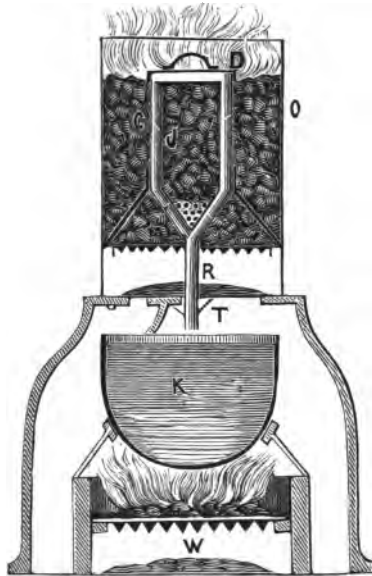

FIG. 27.—Andres' Varnish-making Plant.

quantity of linseed oil heated by the furnace W to a suitable temperature. When one operation is finished it is not customary to clean the copper cylinder because the slight coating of resin which remains on the metal prevents it from being attacked by succeeding fusions, but, on the other hand, the resin in contact with this coating becomes coloured, as it is easily charred.

But by this process the distillation of copal cannot be conducted with the requisite precision, and it is preferable on the large scale to use a proper distilling plant fitted with an internal agitator, and communicating with a condenser (Fig. 28). The gum resin may be heated over the naked fire, or, what is better, by means of a bath of molten lead or a sand bath. The still is suitably connected at the bottom with a wide pipe, so as to enable it to be emptied. This



pipe should be so arranged as to be sufficiently warm to prevent the copal from solidifying in it, and, on the other, so that the receiver may be completely emptied after each operation.

3. There are many modifications of the above process. Worstall and Hackathorn's consist in submitting varnish resins to the action of heat, such heat being applied in a degree such as to reduce such gum or resin to a state of fluidity; automatically removing same from the source of heat as fast as it becomes sufficiently fluid to flow freely; condensing the vapours of the gum or resin formed during such heating; discharging such fluid gum or resin into heated oil, and incorporating the distillate formed by condensation of such vapours into the mixture of oil and gum or resin.

4. This is a clumsy adaptation of superheated steam to Andres' and Tingry's plant for fusing resins by fire heat. It is claimed for this laborious process that the fusion of resins by superheated steam

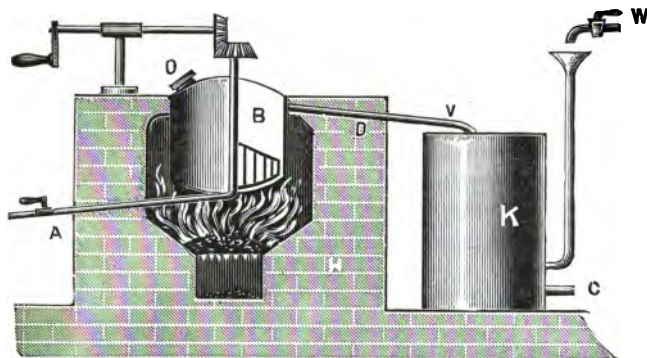

FIG. 28.—Distilling Plant and Condenser for Fusing Copals. A, tap for running off fused copal; B, melting pot with mechanical agitator; D, pipe leading to condensing worm (V); K, condenser; W, water tap; C, exit of copal oil; H, masonry of furnace.

has the great advantage that by its aid all over-heating of the resin may be avoided, and that as soon as the desired result is attained the resin can be forthwith removed from the further action of heat (Fig. 30). The still is an oval cylinder of strong copper plate the inside of which is covered over before use with the best quality of amber varnish. There are two outlet pipes, D and K; D carries the fumes to a condenser; K, in which a wire sieve is adjusted, is used to run off the fused resin. The elevated end of the cylinder has a well-fitted lid which is luted on when the plant is in use. The cylinder C is enclosed within another cylinder C<sup>1</sup> so that there are a few inches of free space between them. C<sup>1</sup> is of iron and is coated with asbestos to avoid loss of heat by radiation. The superheated steam enters the steam jacket through W and makes its exit through W<sup>1</sup>, which also forms an escape for the condensed water. The cylindrical plant is adjusted on sloping standards so that the fused resin can readily run

off through K. When the inner cylinder is charged and the plant ready for working, the superheated steam is run in through W until the first drops of the distillate come over and fused begins to flow from P. The contents of the still are now at the temperature at which dry distillation begins, and the steam is regulated so that distillation goes on with uniform regularity. When the distillation is finished the steam is turned off and the whole plant allowed to get quite cool before it is opened. Such a still can take 22 to 33 lb. at a charge. In order to work on a larger scale it is advisable not to procure a larger still but to have several (comparatively) smaller ones so that no delay entailing stoppage of work need occur during the time the large stills are cooling. If six stills are started in succession the first is usually cool enough to be recharged and started again with a fresh charge by the time the sixth is got to work. The work can thus be arranged in a cycle and go on without intermission, only one of the

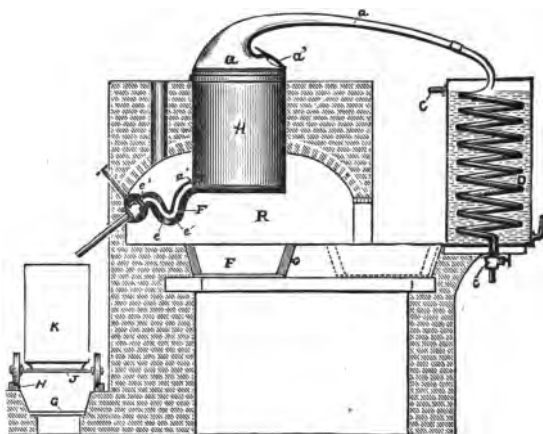

FIG. 29.—Worstall and Hackathorn's Varnish-making Plant.

stills being out of use at any one time, so a very appreciable amount of steam is saved. But plant of this nature would treble the staff of present varnish factories. The following is a far more practicable scheme and has at least the merit of a business-like and labour-saving look about it.

5. *Lehmann's Process for Running Copal by Superheated Steam.*—The plant for "running" copal and amber for varnish manufacture by superheated steam is based upon the same principles as that adopted for the boiling of linseed oil by superheated steam (vol. i., p. 47, Fig. 17 and context). Here again the superheater is placed outside the melting-room. The copal is melted in a closed copper cylinder, the bottom part of the cylinder forming the actual fusing compartment. It is surrounded by an iron jacket in which superheated steam circulates. The heat in the fusion space is shown by a pyrometer. The upper part of the copper cylinder is sufficiently

capacious to allow for the intumescence and consequent ascension of the copal. It is closed by a still-head, which can be removed when required. In this head are two apertures for charging the cylinder, which also serve as peep-holes for watching the progress of the fusion and for the taking of samples from time to time. From the still-head the fumes are led through a cooled pipe to a cooler where they condense. The product of the condensation copal oil is collected. The uncondensable gaseous portion of the fumes are led below the grate of the superheater and burnt on its furnace hearth. Beneath the melting vessel is the mixing vessel in which the oil required for dissolving the copal is heated from 248 to 302° F. by the waste steam from the melting vessel. When the whole of the copal is fused it is run down into the mixing vessel and thoroughly incorporated with the hot oil. The addition of turpentine is effected in another room after the mass has cooled sufficiently. In well-equipped factories the mixed solu-

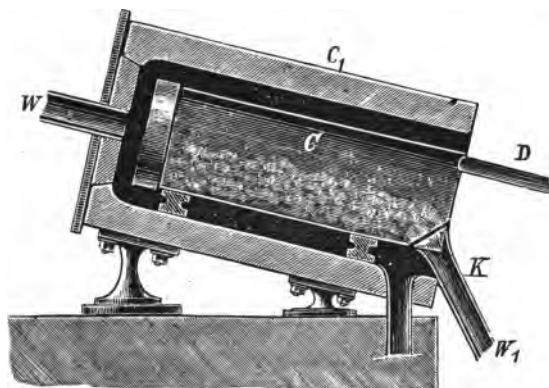

Fig. 30.—Schweizer's Superheated Steam Plant for Fusing Resins.

tion of oil and resin whilst still warm is pumped to the receiving tanks in the room where it is mixed with turpentine. After discharging the fusing cylinder a fresh charge of copal is immediately introduced and another mixing vessel charged with the right amount of oil and the sequel of operations started afresh. The cylinder is cleaned by soda lye.

M. Holtzwich, of Dresden, has proposed the use of superheated air circulating in closed vessels. The gaseous products which escape are passed through a condenser, and their physical appearance, as well as their quantity, indicate the moment when the operation should be stopped. The hot air as it leaves the apparatus might find an application in the oxidation of linseed oil for use in the manufacture of oil varnishes. But superheated air has no latent heat, it is therefore uneconomical.

*Buildings and Appliances used by Wilson Neil in the Manufacture of Varnish.*—Every person intending to manufacture varnish on a

profitable scale ought to procure suitable premises some distance out of town and sufficiently large for the scale of business intended. The building or shed wherein varnish is made ought to be quite detached from any other buildings whatever to avoid accidents by fire. For general purposes a building about 18 feet by 16 feet is sufficiently large for manufacturing 4,000 gallons and upwards annually if there are other convenient buildings for the purpose of holding the utensils and warehousing the necessary stock. On the fixtures and utensils for manufacturing varnish on a scale of the above extent we shall give the most plain and ample directions, point out the least expensive method, and afterwards leave every future operator to judge for himself of the number, size, form and quality of the fixtures

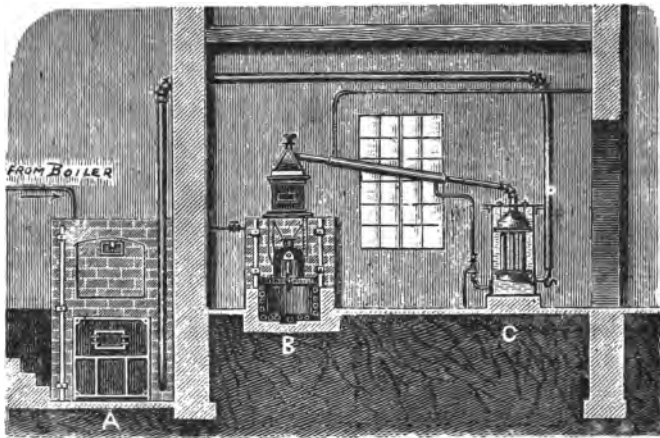

FIG. 31.—Fireproof Varnish-making by Superheated Steam and Fume Consuming Plant.

A, superheater burning uncondensed fumes; B, gum-melting still, the fused resin running into the hot oil in vessel beneath heated by steam coil; C, condenser with overhead pipe leading uncondensed fumes to superheater.

and utensils which he may require according to his intentions and circumstances.

1. *Buildings*.—Procure a building or erect one 18 feet long by 16 feet wide, the back wall 18 feet long and 18 feet high, the front 18 feet long and 9 feet high, with a doorway in the centre 4 feet wide with folding doors made to lift off from the hinges; let the roof slope to the front; fix also in each end wall a frame and door 4 feet wide and made to lift from off the hinges also, so that when necessary there may be a free draft through the premises. Let three skylights be made each 4 feet long by 3 feet broad and fixed in the roof, not directly over the furnaces but on one side, so as to throw light on the furnaces. Next have three frames exactly the size of the frames of the skylights, well grooved and battened with broad

flaps to open on the outside, hung at the top with hinges and capable of being raised by a spring lever and cord inside as occasion may require. The skylights and flaps must be well secured by lead flushings to prevent wet getting in, which might be attended with serious consequences.

2. *Set Pot Furnace* (Figs. 34, 35).—Supposing the roofs and doors all complete in the left-hand corner, against the back wall dig out a foundation 4 feet by 4 feet and 2 feet below the intended level of the floor, level the mould of the foundation, lay a course of brick and mortar all over, taking care that where the ashpit is to be the bricks are good and well laid. Mark out the circumference of the pot mouth upon the ground with 9 inches space all round between the walls and the circumference of the pot. If the pot be 30 inches diameter at

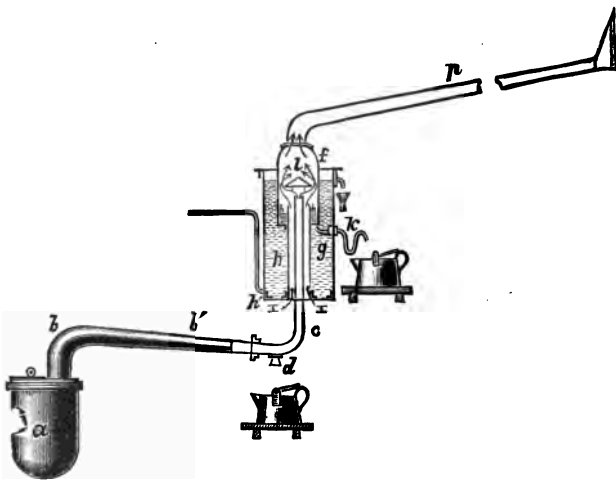

FIG. 32.

FIG. 32.—Plant for Fusing Copal and Condensing the Fumes as Copal Oil.  
*a*, resin still with safety valve; *b*, *b'*, *c*, still head bent twice at right angles and capped by cone, *l*; *f*, condenser; *h'*, cold water entrance with exit; *p*, reflux pipe.

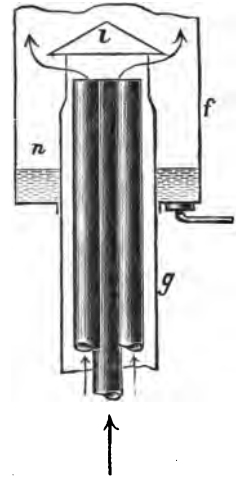

FIG. 33.

FIG. 33.—Section of Condenser.

the mouth, begin the ashpit and raise it four course of bricks high and 9 inches thick all round the ashpit, carefully filling up and treading in a solid foundation of earth, clay or rubbish, level with the ashpit, then lay on a piece of flat iron across the back of the ashpit and another strong piece in front 2 feet 2 inches from the back for the wrought-iron bars to lie on, which bars are to be  $1\frac{1}{2}$  inches broad at top and 2 inches broad and flat at the ends, so that when laid close there will be half an inch space between the bars. The bars to be 2 feet in length. The ashpit being 16 inches wide requires seven bars. When the bars are laid on then set the door frame and door, let the door be 1 foot wide by 9 inches high. Then build the fireplace over the bars three courses high with good sound Welsh or Stourbridge bricks, levelling and enlarging the fireplace on

each side as it rises up, leaving a flue 8 inches broad by 6 inches high slanting upwards to the right. Upon the third course of bricks lay another course of bricks with their inner and upper edges chipped off, so that the pot can be placed on them in the centre, where it is to be well secured by carrying up the remaining work with common bricks forming and carrying up the circular brick work, also bringing the flue round in a spiral form leaving it 5 inches wide and 7 inches high, taking care not to carry the flue too high up the pot sides, for if too high it will be in danger of being overheated sometime when the pot is not near full and thereby setting fire to the contents. The last or finishing coat of bricks ought to be laid in composition, with the inner ends under the flange of the pot mouth and with the outer end a little raised upwards. This pot being complete, call it the set pot (Figs. 34, 35); it is used for the purpose of boiling oil, gold size, Japan and Brunswick black.

3. *Boiling Pot Furnace*.—Dig out a foundation facing the front door against the back wall 4 ft. square and 2 ft. deep, lay one course of brick and mortar as before, build up an ashpit exactly as before, only leave a distance of 1 foot between the back end of the ashpit and the

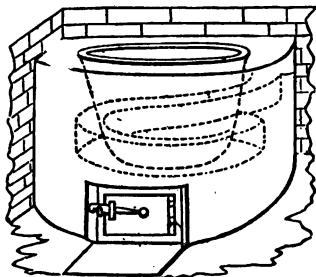

FIG. 34.—Wilson Neil's Set Pot and Furnace for Boiling Oil, Gold Size, Japan and Brunswick Black.

wall. When the pit is raised four bricks high lay on seven bars as before, placing the frame and door in front, then build a circular fireplace of 21 inches in diameter four bricks high formed with the halves or square ends of Welsh or Stourbridge bricks well laid and close set, float the surface of the top course well and have ready the cast-iron plate, dimensions 35 inches by 35 inches, 1 inch thick with a circular hole 17 inches diameter in the centre of the plate. A flue to be left at the back of the brickwork 8 inches wide by 6 inches high into the chimney shaft. Finish the ashpit outside the furnace door with a grating to fit, then it will be complete.

4. *Gum Furnace* (Fig. 36).—Against the back wall in the right-hand corner dig out a foundation 3 feet by 3 and 2 feet deep, lay a course of brick and mortar, mark out and erect an ashpit, the back of which is to be 16 inches by 28 inches in length, raise it five bricks high, carrying up the other part of the brickwork at the same time 30 inches long by 37 inches broad in front; then level all round and tread in solid, lay a

piece of flat iron at the back and two pieces in front to receive and rest the bars (seven in number) the same thickness as the others, only 13 inches extreme length, including  $1\frac{1}{2}$  at each end made flat to the breadth of 2 inches; 9 inches clear of the brickwork lay the bars and raise a circular fireplace 9 inches diameter inside without any door or frame in front only leaving the ashpit open. Carry up 4-inch brickwork between the fireplace and the front with Welsh or Stourbridge brick ends, set in loam round the fireplace; they must be laid close and solid, the outer ends of them well wedged. Above the third course leave a flue at the back 8 inches wide and 6 inches high to communicate with the chimney shaft. On the third course above the bars lay two more courses of brick rather levelling or widening the furnace at the top. Have ready a plate cast on purpose  $\frac{3}{4}$  of an inch thick, 30 inches long from back to front, and 30 inches wide, with a circular hole of 11 inches diameter, not in the centre of the plate but only 6 inches from the front end. Finish the perpendicular brickwork square with the edges of the plate, lay a movable grating over the ashpit in front and it is complete. All furnaces require to have slow fires in them for a day in order to dry them slowly and prevent their cracking.

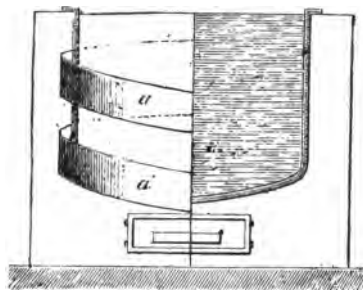

FIG. 35.—Wilson Neil's Set Pot (Section, after Andes).

5. *Gum Pot*.—Procure a copper gum pot (*a, b*, Fig. 36) to fit into the last furnace; the dimensions are 2 feet 9 inches high from top to bottom,  $9\frac{1}{2}$  inches diameter across the bottom outside. The bottom is hammered out of a solid block of copper and fashioned all of one piece exactly like a hat without the brim. The upper part of the pot (*b*) is made of sheet copper of a cylindrical form 10 inches diameter at top and 2 feet 2 inches high, about  $\frac{3}{8}$  of an inch thick, the lower part of the cylinder is then riveted to the bottom with copper rivets, the heads of which are inside and project through the lappings of the copper, flattened on both sides. Previous to riveting on the bottom a flange of copper of about  $\frac{3}{8}$  of an inch thick is fixed on to the bottom part under the large rivets. It is fixed horizontally round the pot. Also previous to riveting on the bottom put on the iron hoop (*d*)  $1\frac{1}{2}$  inches in breadth, to which is welded an iron handle made 1 inch broad by 1 inch thick, gradually increasing to 2 inches in breadth but decreasing in thickness. The length from pot to handle end 2 feet 8 inches.

6. *Boiling Pot*.—Procure a copper pot to fit boiling pot furnace (p. 114), the bottom to be beat out of the solid as the gum pot and of the following dimensions. Diameter across the bottom outside 20 inches, height of bottom 7 inches, the cylindrical or body part of the pot to be 2 feet 10 inches in depth and joined to the bottom part with strong copper rivets and made to project through at least  $\frac{3}{4}$  of an inch and to be well hammered inside and out, for as there is no flange the rivets must be large and strong to support the weight of the pot and its contents while boiling on the furnace plate. It ought to fit the plate neatly, yet so easily as to lift off freely. Seven inches below the mouth of the pot fix on two strong iron handles, one on each side, riveted through. Each end with two strong rivets, the space for the handle to be 7 inches and  $1\frac{1}{2}$  inches diameter, and to project 4 inches from the pot sides.

7. *Sundry Utensils*.—Two copper ladles made to hold 2 quarts each, with the bowl part beat out of the solid copper and riveted to a rod of the same metal  $3\frac{1}{2}$  feet long and  $\frac{3}{4}$  of an inch in diameter, and finished with a turned hardwood handle 7 inches long riveted at the

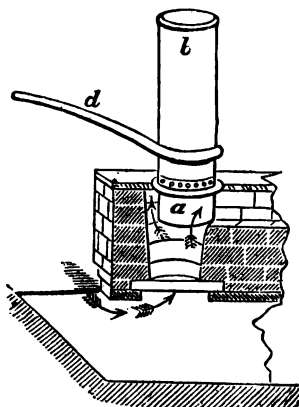

FIG. 36.—Wilson Neil's Gum Pot (general view).

end. Two good ladles for the iron set pot made of sheet copper or sheet iron (cast-iron being too heavy) with good ash handles. For a pot of 40 gallons or upwards, the ladle to hold 3 quarts. Handle 5 feet long, tapering towards the hand. Two copper stirrers made from three-quarter diameter copper rods  $3\frac{1}{2}$  feet long, beat flat at the one end to  $1\frac{1}{2}$  inches in breadth, 8 inches up the rod, to be finished with ferruled hands 7 inches in length. One large, strong, well-made copper funnel with lapped seams for straining boiling varnish or oil (tin or soldered ones would melt). One copper oil jack which will contain 2 gallons for pouring in hot or boiling oil, with a large, strong, pitcher-fashioned handle and spout in front. One brass or copper sieve containing sixty meshes to the inch for straining the first varnish. One brass sieve containing forty



meshes to the inch, 9 inches diameter, for straining gold size, turpentine, varnish, boiled oil. One brass sieve containing forty meshes to the inch, and 9 inches diameter, for straining Japan and Brunswick black. One saddle, which is a sheet of plate iron or tin 12 inches broad and turned  $1\frac{1}{2}$  inches at each side; it is to lie from the edge of No. 1 pot on the edge of the funnel to prevent the spilling of the varnish during the time of taking it out. One tin pouring pot to hold 3 gallons made exactly like a garden watering-pot only smaller at the spout and without any rose; this is never to be used for any purpose except for pouring oil of turpentine into the varnish (Figs. 37 and 43). One 3-gallon tin jack made with a strong handle at back and a large broad spout in front, used for receiving the washings when poured out from the gum pot. A small broom termed a swish, made from the waste cuttings of cane tied on a small handle like a hearth broom, the head 5 inches long and 5 inches round with handle 3 feet; its use is for washing out the gum pot each time it is used, to be always kept clean and left in oil of turpentine. One iron trevet, made with a circular top 14 inches diameter with four small cross bars, the three feet of the trevet 12 inches high; it is used for setting the gum pot upon with its bottom upwards for a minute between each running.

## CHAPTER VI.

### OIL VARNISH-MAKING: GENERAL INSTRUCTIONS.

VARNISHES in which a resin is dissolved in a volatile solvent, which on evaporation leaves a coating of resin pure and simple as in the case of spirit varnishes, are not adapted for outdoor work, nor for application to any object subject to wear and tear. They certainly yield brilliant but not durable coatings. They have in fact but very feeble capacity to resist heat and moisture and the vicissitudes of the weather. Moreover, spirit varnish coatings are soluble in fresh spirit varnish, especially in a thin spirit varnish. As they consist after drying of the unchanged, more or less brittle, resin, their inability to stand rough usage or even ordinary wear and tear, will be readily appreciated. It is therefore necessary to introduce into the varnish an element which in virtue of its elasticity, impermeability and general insolubility, when dried, will impart the necessary resistance and durability, whilst at the same time it is so transparent that it does not attenuate but in the smallest possible degree the brilliancy of the varnish. The only substance which fulfils these conditions is the oxidation product of drying oils—*linoxin*. The varnishes into which drying oils like linseed oil enter are called oil varnishes. The ultimate air oxidation product of linseed oil does not dissolve either in linseed oil or in spirits of turpentine or in methylated spirits even when strongly heated in these vehicles or solvents. These vehicles have scarcely any more solvent action on thoroughly dried oxidised linseed oil than they have upon tanned leather. It is therefore a great benefit to be able to apply a second coat, or a third, or even more coatings, without the last coating in each case affecting the previous one in any way whatever. This constitutes one of the great virtues of linseed oil, which is not appreciated by any manner of means to the extent which it deserves, and constitutes a desideratum in any substitute for linseed oil. Those who run after cheap substitutes for linseed oil in the words of the proverb "go further and fare worse". They sacrifice the great boon of impermeability and insolubility to cheapness, with the inevitable result. Pure linseed oil is the only substance at present known which acts in this way in a manner approaching perfection. As linseed oil and methylated spirits are not miscible, the latter does not enter into the composition

of oil varnishes, and spirits of turpentine, preferably American or French, has to be used instead. One or other of these essential oils therefore is used to dilute or thin down the solution of resin in linseed oil which would otherwise be too viscous to be easily spread by the brush on any given surface. On the evaporation of the spirits of turpentine from any given oil varnish, there is left behind a homogeneous layer of the dissolved mixture of resin in linseed oil, previously dissolved in the spirits of turpentine to form the varnish. The air has effected a partial analysis of the varnish, the volatile constituent has been evaporated and diffused into the surrounding air, but not necessarily as spirits of turpentine. Spirits of turpentine oxidises in bulk in a liquid state; how much more readily must it oxidise when diffused through the air in the state of vapour? The effect of the oxidation of linseed oil on the superincumbent atmosphere during the oxidation of the linseed oil in paint has been discussed in vol. i., pp. 1, 2. The remarks made concerning the drastic diminution of the oxygen in the air by the drying of linseed oil in paint, apply with redoubled force in the case of oil varnish. Not only is the air depleted of oxygen by the drying of the linseed oil in the varnish but this great attenuation of the oxygen is greatly accentuated, when the air is not only robbed of the oxygen necessary to oxidise the oil but also of that required to oxidise the vaporised spirits of turpentine, which is none the less oxidised, even if the oxidised product be not readily tangible.<sup>1</sup> What is tangible is oxidised, in fact a greater or less amount of oxidised or resinified spirits of turpentine is always left behind, and contributes to a certain extent to the tackiness of the varnish before and after final drying. The proportion of oxidised or resinified spirits of turpentine will depend so far on the nature and age of the spirits of turpentine used in making the varnish, *i.e.*, on the extent to which the spirit of turpentine was resinified before being used as a varnish solvent. Non-resinified spirits of turpentine cedes nothing to caustic soda, it does not even colour the alkaline solution thereof. The function of the linseed oil is to impart impermeability, elasticity and durability, the function of the spirits of turpentine is principally as a thinner, *i.e.*, as a simultaneous diluent, solvent, and volatile vehicle. Some say it acts as an oxidising agent and thus assists in the drying of the varnish; but a well-made oil varnish should dry equally well whether spirits of turpentine, benzol or rectified petroleum spirit be the volatile diluent used. Ingredients which will not form a quick drying varnish with petroleum spirit or "white" spirit will certainly not do so with spirits of turpentine.

The use of a protective coating with linseed oil as a basis was indicated by the monk Theophilus so far back as the twelfth century.<sup>2</sup>

<sup>1</sup> The white crystal-like substances deposited on water laid for the purpose in a room newly painted with white lead paint do not consist of white lead but of a camphoraceous body produced by the oxidation of the turps used in the paint.

<sup>2</sup> "Pieces of copper coin struck in the reign of Trajan and dug up from ancient ruins are covered, as Count Caylus remarks, with a kind of resinous varnish similar to that

But for a long time oil varnishes were only made in small quantities by each tradesman, in accordance with recipes transmitted from father to son and according to the exigencies of his own personal work. The first varnish factory was established in England in 1790, in France and Germany between 1820 and 1830, and in Austria in 1843. The composition of oil varnish is simple, since it only contains resin, drying oil and a volatile solvent. But there are many different qualities of oil varnish, which vary with the quality and relative proportion of the different ingredients and the manufacture.

Oil varnish could not possibly have been a secret to the Greek artists. Appelles' varnish resembled it. Do artists, chemists and connoisseurs know of any liquid substance or mixture fit to produce these effects besides the varnishes? If not, as seems to be the case, Appelles and the Greeks were undoubtedly acquainted with oil varnishes, a fact which cannot be questioned and which might be strongly urged on behalf of their knowledge of oil colours.

The qualities desired in a varnish are: (1) colour. This should be as pale as possible so as not to appreciably alter the tone or tint of any object to which it may be applied or that of any colouring matters which may be added to the varnish; (2) consistency or body so as to be easily applied; (3) drying properties; (4) brilliancy; and (5) resistance.

1. *Colour.*—The colour of the varnish will be paler the greater the amount of care that has been taken in the selection and cleansing of the resins and in the selection and preparation of the oil made from well-matured pure linseed, and in the refining and bleaching of such oil, and careful as well as prolonged tanking of the same, and the greater the amount of attention with which the exact temperature necessary for the fusion of the resins in the most appropriate vessels as regards size and shape has been regulated. Lead driers tend to darken varnish. But pale varnishes are not always appropriate. Dark-coloured varnishes accentuate the beauty of dark wood, and to enhance this effect still further dyes are often dissolved in varnish to still further accentuate the colour of the wood so that one imagines he is looking through coloured glass on to a smooth polished opaque matrix of the same colour. But lead driers have a marked action on delicate colours, especially vegetable colours.

2. *Consistency.*—The consistency of a varnish depends on the relative proportion of the three ingredients, oil, resin and volatile solvent, and the extent to which and the manner in which the mixture of oil and fused resin has been "boiled" before the incorporation of the spirits of turpentine or other solvent.

which would result from a mixture of oil and black pitch" (*Tingry's Varnishes*, Preface). "Linseed, walnut and poppy-seed oil were known to Theophilus and probably all of them to the Greek painters as drying oils fit to be used in painting. Linseed oil could not have remained long unknown to the Egyptians. Great cultivators of flax, skilful in the arts and in medicine, they could not have overlooked the production of an oil from the linseed nor have been ignorant of its peculiar properties" (*Hendry's Theophilus*, p. 94).

3. *Drying Properties.*—These depend on the quality of the resin and the drying oil and the nature and amount of the driers used and the extent to which and the manner in which the mixture or solution of oil and fused resin has been boiled prior to the incorporation of the spirits of turpentine or other solvent. Quick drying depends also on the rapidity and thoroughness with which the volatile solvent evaporates oil. The more care taken in the boiling of the mixture of oil and resin the better will the varnish dry. Some resins do not dry so well as others for very obvious reasons, and some pitches, *e.g.*, blast furnace pitch, stearine pitch, require drastic treatment with energetic driers before they can be made into quick-drying varnish.

4. *Brilliance and lustre* depend on the nature of the resin. The greater the ratio of resin to oil the greater is the brilliance and lustre of the varnish. As a matter of fact the brilliance of a varnish is a property dependent on its index of refraction. As the index of refraction of a resin is greater than that of linseed oil, the more resin there is in a varnish the more lustrous it is. Hence the reason why spirit varnishes after drying are more lustrous than oil varnishes. Each unit per cent. of oil in the dried coating of an oil varnish diminishes its lustre *pro rata*. On the other hand, even if it increases the lustre proportionately, each unit per cent. of resin in varnish after a certain amount diminishes its durability *pro rata*. A compromise has therefore to be made according to the object in view in designing a varnish for any given purpose. Where brilliance is a desideratum the resin must not be less than  $\frac{1}{3}$  to  $\frac{1}{2}$  by weight of the dried coat. But where brilliance leaves off durability is only beginning, and varnishes in which the resin only forms  $\frac{1}{3}$  of the dried coat are used where great elasticity is demanded. In the case of a piano varnish, for instance, durability is to a certain extent sacrificed to lustre, and the percentage of resin to oil preponderates in such a varnish. The harder the resin the greater the brilliance. A Manilla varnish made with the same number of gallons of linseed per 100 lb. of Manilla is less lustrous than one made in the same ratio of oil to resin from Zanzibar copal. It is asserted that the index of refraction of a varnish is greater than that calculated from its composition, but this may be due to a turpentine residuum left out of the calculation. Be this as it may, the skill and care with which a varnish are made are factors which cannot be lost sight of in any investigation into the cause of the brilliance of varnish.

5. *Durability and resistance* will vary with the proportion of linseed oil and the elasticity of its oxidation product. Varnishes should embody the brilliance of the resins and the elasticity of the drying oils. Varnish from Zanzibar copal may last as many years as that from low grade resins may do weeks. The latter soon lose their brilliance, become lack lustrous and finally dull, and then after the formation of fine cracks assume a whitish appearance and finally are resolved into small pulverulent scales.

*Choice of Raw Materials* : (1) *Resins*.—The resins employed ought to be carefully selected, as indicated in the preceding part, whilst treating of the raw materials employed in the manufacture of varnish. Hard copals and amber have to be submitted to a high temperature before they dissolve. They are generally rendered soluble in oil during the process of varnish-making; sometimes, however, the process is so modified that resins which have sometime previously been heated to the requisite extent (pyrosuccin, pyrocopal) may be used. The colour and brilliancy of the varnish will depend upon the amount of care exercised not only in the selection of the resins, but their previous treatment and the skill exercised in running them.

(2) *Linseed oil*.—Linseed oil is the drying oil generally used. Its quality is of prime importance, for upon that depends the drying properties, elasticity, and the resistance and durability of the varnish. High-class varnishes can only be made from pure and perfectly refined oil. It ought to be "aged" for at least a year, no matter whether raw oil, or manganese or lead-boiled oil be used. Every varnish-maker in buying linseed oil should do so according to sample. He should test the tendency of the sample to "spawn," and the same tendency of a sample drawn from each cask constituting the delivery. Oil not up to sample should be refused delivery. The oil before being used for varnish-making ought previously to have absorbed a certain quantity of oxygen, so as to render it more drying. The temperature at which the oil decomposes ought to be taken into account, for at the high temperature at which copal melts, certain oils darken very rapidly. The driers with which the oil has been boiled ought also to be considered. Manganese compounds are less hurtful than those of lead, because the linoxate of manganese is less brittle than linoxate of lead; further, there is less manganese absorbed by a manganese-boiled oil than there is of lead by a litharge-boiled oil. Many manufacturers, chiefly in England, prefer to use only oil which has been boiled for a prolonged time without any addition of drier (Stand Oil) and which has afterwards been stored for a long time; such an oil is pale in colour, is not altered by sulphur compounds, and durable varnishes are made from it even with soft copals.

*The Choice of Linseed Oil for Varnish-making*.—The choice of linseed oil (says Wilson Neil) is of peculiar consequence to the varnish-maker, as upon its quality, to a great extent, depends the beauty and durability of the varnish. Oil expressed from green, unripe seed always abounds with watery, pulpy, acidulous particles. The quality of oil may be determined in the following manner. Fill a phial with oil, and hold it up to the light; if bad it will appear opaque, turbid and thick; its taste is acid and bitter upon the tongue, and its smells rancid and strong; this ought to be rejected. Oil from fine, full-grown, ripe seed when viewed in a phial will appear limpid, pale and brilliant; it is mellow and sweet to the taste, has very little smell, is specifically lighter than impure oil, and

when clarified dries quickly and firmly and does not materially change the colour of the varnish when made but appears limpid and brilliant.

*Directions for Clarifying Oil for Varnish (Wilson Neil).—*Procure a copper pan made like a common washing copper which will contain from 50 to 80 gallons as occasion may require. When wanted set it on the boiling furnace (p. 114), and fill it up with linseed oil within 3 inches of the brim. Kindle a fire in the furnace underneath and manage the fire so that the oil shall gradually but slowly increase in heat for the first two hours, then increase the heat to a gentle simmer, and if there is any scum on the surface, skim it off with a copper ladle, putting the skimmings away. Let the oil boil gently for three hours longer, then introduce by a little at a time one-quarter of an ounce of the best calcined magnesia for every gallon of oil, stirring the oil from the bottom. When the magnesia is all in let the oil boil rather smartly for one hour, it will then be sufficient. Lay a cover over the oil to keep out the dust while the fire is drawn and extinguished by water, then uncover the oil and leave it till next morning, and then while it is yet hot ladle it into the carrying jack, or let it out through the pipe and cock; carry it away and deposit in either a tin or leaden cistern, for wooden vessels will not hold it. Let it remain to settle for at least three months. The magnesia will absorb all the acid and mucilage from the oil, leaving the oil clear, transparent and fit for use. Recollect when the oil is taken out not to disturb the bottoms, which are only fit for black paint. The clarification can nowadays be very well carried out in a lead-lined tank fitted with a steam coil supplied with high pressure steam.

*Directions for Making Varnish on the Small Scale.—*First procure a gum-pot (Fig. 36), or smaller if required, then a three-footed iron trevet with a circular top, the feet 16 inches in length and made to stand wider at the bottom than top, which is to be made so as the pot will fit easily into it. Place the trevet in a hollow in a field, yard, garden or outhouse where there can be no danger from fire; raise a temporary fireplace round the trevet with loose bricks after the same manner that plumbers make their furnaces, then make up a good fire with either coke, coal or wood charcoal, which is far preferable; let the fire burn to a good strong heat, set on the gum-pot with 3 lb. gum copal. Observe that if the fire surround the gum-pot any higher inside than the gum it is in great danger of taking fire. As soon as the gum begins to fuse and steam put in the copper stirrer, and keep cutting, dividing and stirring the gum to assist its fusion, and if it feels lumpy and not fluid and rises to the middle of the pot, lift it from the fire and set it on the ash-bed, and keep stirring until it goes down (meantime let the fire be kept briskly up); then set on the gum-pot again and keep stirring until the gum appears fluid like oil, which is to be known by lifting up the stirrer so far as to see the blade. Observe that if the gum does not appear quite fluid as oil, carry it out whenever it rises to the middle of the pot and stir it down again (keep up a brisk fire).

Put on the pot and keep stirring until the gum rises above the blade of the stirrer ; call out to the assistant " be ready " ; he is then, with both hands, to lay hold of the copper pouring jack, charged with clarified oil (see p. 123), and lean the spout about  $1\frac{1}{2}$  inches over the edge of the gum-pot ; let him keep himself firm, steady and collected, and not flinch, spill or pour the oil which would perhaps set all on fire. Observe, when the gum rises within 5 inches of the pot mouth and call " pour " ; the assistant is then to pour the oil very slowly until towards the last, the maker stirring during the pouring. If the fire at this time is strong and regular, in about eight or ten minutes the gum and oil will concentrate and become quite clear. This is to be tested by taking a piece of broken window-glass in the left hand, and with the right lifting up the stirrer and dropping a portion of the varnish on it ; if it appears clear and transparent, the oil and gum are become concentrated or joined together. It is now to be further boiled until it will string between the finger and thumb. This is known by once every minute dropping a portion on the glass, and taking a little between the forefinger and thumb ; if it is boiled enough it will stick strong and string out into fine filaments, like bird lime ; but when not boiled enough it is soft, thick and greasy, without being stringy. The moment it is boiled enough carry it from the fire to the ash-bed, where it must remain from fifteen to twenty minutes, or until it is cold enough to be mixed. Have at hand a sufficient quantity of oil of turpentine to fill the pouring pot ; begin to pour out with a small stream, gradually increasing it, and if the varnish rises rapidly in the pot keep stirring it constantly at the surface to break the bubbles, taking care not to let the stirrer touch the bottom of the pot, for, if it should, the oil of turpentine would be in part converted into vapour and the varnish would run over the pot in a moment ; therefore, during the mixing keep constantly stirring as well as pouring in at the same time. Have also a copper ladle at hand, and if it should rise so far as to be unmanageable, let the assistant take the ladle and cool it down with it, lifting up one ladleful after another and letting it fall into the pot. As soon as the varnish is mixed, put in the varnish sieve No. 1 in the copper funnel, placed in the carrying tin, and strain the varnish immediately. Empty it into open-mouthed jars, tins or cisterns ; there let it remain to settle, and the longer it remains the better it will become. Recollect when it is taken out not to disturb or raise up the bottoms.

*Precautions to be Observed in Making Varnish.*—Previous to beginning to make varnish take care that the making-house is completely cleared of every unnecessary article. Have every necessary article perfectly clean and in good order. If the weather is fine, at a convenient distance outside sift some dry ashes through a fine sieve to form an ash-bed ; make it a little larger than the bottom of the boiling pot,  $1\frac{1}{2}$  inch deep, and smooth and level on the surface, on which set the boiling pot every time it is necessary to bring it out. About 4 feet from the ash-bed erect a circle of loose



bricks, four courses high ; lay them so that when the gum-pot is set within it will rest securely by its flange with the bottom about 6 inches from the ground. Upon this brick stand set the pot each time there is occasion to carry it out and stir it down ; 4 feet from the stand set the iron trevet for turning up the gum-pot each time after it is washed out, as by so doing it will always be kept clean and cool gradually, for by cooling very rapidly copper oxidises very quickly. Near the trevet set the large wide tin jack, ready to receive the washings, also the swish broom each time the pot is washed out. Have also at hand one copper ladle and a tin bottle with 3 gallons of oil of turpentine for washing with when wanted. Supposing everything so far ready, if both the boiling pot and gum-pot are to be used at the same time, let the assistant lay the fire ready, set on the boiling pot with 8 gallons of oil, kindle the fire, then lay the fire in the gum furnace ; have as many 8 lb. bags of gum, all ready weighed up, as will be wanted ; put one 8 lb. into the pot (in three minutes if the fire is brisk), the gum will begin to fuse and give out its gas, steam and acid. Stir and divide the gum and attend to the rising of it as before directed : 8 lb. of copal takes in general from sixteen to twenty minutes in fusing from the beginning till it gets clear like oil, but the time very much depends on the heat of the fire and the attention of the operator. During the first twelve minutes while the gum is fusing the assistant must look to the oil and bring it to a smart simmer, for it ought to be neither too hot nor yet too cold, but in appearance beginning to boil, which he is strictly to observe, and when ready call out "bear a hand" ; then immediately each lay hold of one handle of the boiling pot, lift it right up so as to clear the plate, carry it out and place it on the ash-bed, the maker instantly returning to the gum-pot, while the assistant puts three copper ladlefuls of oil into the copper pouring jack, bringing it in and placing it on the iron plate at the back of the gum-pot to keep hot until wanted. When the maker finds the gum is nearly all completely fused, and that it will in a few minutes be ready for the oil, let him call out "ready oil" ; the assistant is then to lift up the oil jack with both hands, one under the bottom and the other on the handle ; lay the spout over the edge of the pot, and wait until the maker calls out "oil" ; the assistant is then to pour in the oil as before directed and the boiling to be continued until the oil and gum become concentrated and the mixture looks clear on the glass ; the gum-pot is then to be set on the brick stand until the assistant puts three more ladlefuls of hot oil into the pouring jack and three more into a spare tin for the third run of gum. There will remain in the boiling pot still  $3\frac{1}{2}$  gallons of oil. Let the maker put his right hand down the handle of the gum-pot near to the side, with his left hand near the end of the handle, and with a firm grip lift the gum-pot and deliberately lay the edge of the gum-pot over the edge of the boiling pot, and gently raise up the bottom of the gum-pot until all its contents run into the boiling pot. Let the gum-pot be held with its bottom turned upwards for a minute right over

the boiling pot. Observe that whenever the maker is beginning to pour, the assistant stands ready with a thick piece of old carpet without holes and sufficiently large to cover the mouth of the boiling pot, should it catch fire during the pouring, which will sometimes happen if the gum-pot is very hot. Should the gum-pot fire it has only to be kept bottom upwards and it will go out of itself; but if the boiling pot should catch fire during the pouring, let the assistant throw the piece of carpet quickly over the blazing pot, holding it down all round the edges; in a few minutes it will be smothered. The moment the maker has emptied the gum-pot throw into it half a gallon of turpentine and with the swish immediately wash it from top to bottom, and instantly empty it into the flat tin jack. Wipe the pot dry and put in 8 lb. more gum and set it upon the furnace; proceed with this run exactly as with the last; there will then be 8 gallons of oil and 24 lb. of gum in the boiling pot under which keep up a brisk strong fire until a scum or froth rises and covers all the surface of its contents, when it will begin to rise rapidly. Observe, when it rises near the rivets of the handles carry it from the fire and set it on the ash-bed, stir it down again, and scatter in the driers by a little at a time; keep stirring, and if the frothy head goes down, put it upon the furnace and introduce gradually the remainder of the driers, always carrying out the pot when the froth rises near the rivets. In general if the fire be good all the time a pot requires to boil from the time of the last gum being poured in is about three and a half hours, but time is no criterion for a beginner to judge by, as it may vary according to the weather, the quality of the oil, the quality of the gum, the driers or the heat of the fire, etc.; therefore, about the third of the boiling try it on a bit of glass, and keep boiling until it feels strong and stringy between the fingers; it is then boiled sufficiently. Carry it on the ash-bed and stir it down until it is cold enough to mix, which will depend much on the weather, varying from half an hour in dry frosty weather to one hour in warm summer weather. Previous to beginning to mix have a sufficient quantity of turpentine ready, fill the pot and pour in, stirring all the time at the top or surface as before directed, until there are 15 gallons or five tins of oil of turpentine introduced, which will leave it quite thick enough if the gum is good and has been well run, but if the gum was of a weak quality and has not been well fused, there ought to be no more than 12 gallons of turpentine mixed, and even that may be too much. Therefore, when 12 gallons of turpentine have been introduced, have a flat saucer at hand and pour into it a portion of the varnish, and in two or three minutes it will show whether it is too thick; if not sufficiently thin add a little more turpentine, and strain it off quickly. As soon as the whole is stored away, pour in the turpentine washings, with which the gum-pots have been washed, into the boiling pot, and with the swish quickly wash down all the varnish from the pot sides; afterwards with a large piece of woollen rag dipped in pumice powder, wash and polish every part of the inside of the boiling pot, perform-

ing the same operation on the ladle and stirrers ; rinse them with the turpentine washing, and at last rinse them all together in clean turpentine, which also put to the washings; wipe dry with a clean soft rag the pot, ladle, stirrer and funnels, and lay the sieve so as to be completely covered with turpentine which will always keep it from gumming up. The foregoing directions concerning running the gum and pouring in the oil and also boiling off and mixing, are, with very little difference, to be observed in the making of all sorts of copal varnishes, except the differences of the quantity of oil, gum, etc., which will be found under the various descriptions by name which will be hereafter described.

*Experiment to Show that Varnish Improves by Heat.*—Wilson Neil continues : “ Very recently I had a brick erection (2 feet high by 4 feet wide) built all round the warehouse with an air furnace at one end, whereby the heat and smoke were conveyed inside a large flue in the brick work from one end to the other where it joined into a chimney shaft. The brick erection was covered with foot tiles laid in composition, and over the foot tiles was laid a bed 1 inch thick, of fine sand sifted. Upon this sand were set the varnish cisterns 4 feet by 3 and 3 feet deep made of inch and quarter boards and lined with lead. When these cisterns were filled up each held 150 gallons, and a regular fire was kept up in the furnace every other day. During the time the fire was kept the varnish in the cisterns expanded to such a degree that it rose 2 inches in the cistern nearest the furnace. During the time of its expansion it gave out a sickly smell of gas, turpentine and moist air ; but as soon as the furnace begins to cool gradually the acid moisture and driers descend to the bottom of the cisterns, while the varnish on the surface attracts fresh oxygen from the air of the warehouse ; so that by alternately heating and cooling the varnish in this manner for four months it acquired all the properties and qualities equal to varnish which has been kept without heat for twelve months.” Wilson Neil repeatedly tried the experiment and always found it to answer.

*Copal or Oil Varnishes require Age before they are Used.*—Wilson Neil adds : “ I have frequently filled up several cisterns of varnish each containing 150 gallons. When they have stood one month I have varnished a panel with varnish from the surface of each, when I have found every one of the panels dry firm in regular time and have no appearance of pinholes whatever.” “ Again, I have taken out 50 gallons of varnish from each cistern. I then, out of cisterns which had 100 gallons left in each, varnished a panel. I found all these dry in the same time as the first, but every panel was either more or less sleepy or steamy, and appeared as if a fine mist had carried off the glossiness. After taking out about 40 gallons more from each cistern there were only 60 gallons left in each. I then varnished a panel from each cistern ; none of them dried so soon by two hours, and every panel was opaque and full of pinholes. I repeated the same experiment from different cisterns of varnish many times at

various periods from the varnish being made, from one month's age to twelve, and have invariably found that the varnish within 15 inches of the surface is more perfect and sooner ready for use than that beneath it, and that the varnish towards the bottom of all cisterns requires time and the action of warm weather to cause the moisture acid and driers to settle before the varnish is fit to use. All body varnishes are intended, and ought, to have  $1\frac{1}{2}$  lb. of gum to each gallon of varnish, when the varnish is strained off and cold; but as the thinning up or quantity of turpentine required to bring it to its proper consistency depends very much on the degree of boiling it has undergone, therefore, when the gum and oil have not been strongly boiled, it requires less turpentine to thin it up; whereas, when the gum and oil are very strongly boiled together a pot of 20 gallons will require perhaps 3 gallons above the regular proportionate quantity; and if mixing the turpentine is commenced too soon, and the pot not sufficiently cool, there will frequently be above a gallon and a half of turpentine lost by evaporation. All carriage, wainscot, mahogany, etc., varnish ought to have one full pound of gum for each gallon when strained and cold; and should one pot require more than its proportion of turpentine, the following pot can easily be left not quite so strong boiled, then it will require less turpentine to thin it up. Gold sizes, whether pale or dark, ought to have full half a pound of gum to each gallon when it is finished, and best black Japan to have half a pound of good gum or upwards besides the quantity of asphaltum. The foregoing proportions I have found to answer best in general, but recollect if the gum either be of such inferior quality that it will not properly fuse, or if it should, through inexperience or neglect, not be properly fused, however good the quality the produce will be both inferior and deficient, and I am perfectly convinced from forty years' experience that the greatest and most essential part belonging to the business of varnish-making consists in the management and regulation of the fire in the gum furnace, so that the gum from the beginning of its softening in the gum-pot, and during the whole time of its fusion, shall be so managed according to the nature and quality of that particular sort, particularly in increasing the heat, that it shall carry up and out of the pot all or as much gas and acid as is possible, which is most difficult for an inexperienced person to understand, and indeed very few think about it. Every varnish-maker during the time his furnaces are at work ought always to have his assistant at hand whether he is wanted or not, and when anything is to be done quickly, such as lifting a pot from the fire, pouring or anything that requires two persons, never do anything in a hurry or flutter, but always be cool, collected and firm; and to ensure against accidents be prepared to meet them deliberately. A nervous or timorous person is unfit either for a maker or assistant, and the greatest number of accidents occur either through hurry, fear or drunkenness.

*Solvents.*—The spirits of turpentine used as a solvent is the

ordinary spirit ; when the varnish is applied on a surface the spirit never evaporates completely, and the portion remaining oxidises and resinifies ; being softer than the resins used, this residue imparts elasticity and durability to the coating.

Certain manufacturers prefer American spirit to French ; the chief reason is that English varnishes, which are of excellent quality, are made with American spirits, and as the latter possesses a peculiar essence of lemon smell, this smell has become recognised as an indication of superior quality varnish. Since the first edition of this work appeared American spirits of turpentine from many causes has more than trebled in price. All the same the British varnish-maker must have it, because what the odour, flavour and aroma of a pedigree apple, pear, or grape is to the proprietor of an orchard or vineyard in a district where it is indigenous or acclimatised, so is the odour and aroma of American spirits of turpentine to the British varnish-maker. But it is not the aroma alone that is concerned. American turpentine, in virtue of its lower boiling-point, its lower vapour tension, is in every way more suited for varnish-making than either Russian turpentine or the wood turpentine distilled by steam from the wood in the U.S.A.

*Old Tanked Spirits of Turpentine.*—Spirits of turpentine left in an open lead tank until it thickens imparts energetic drying properties to the varnish made from it. Whether this is due to the turpentine oxidising to rosin acids, these attacking the lead and the lead dissolving therein as rosinate, is doubtful. Possibly it may in this state act by its affinity for oxygen as a carrier of oxygen to the oil. "Blown" spirits of turpentine possibly has all the advantages of that thickened by age and exposure.

*The Choice of Essential Oil or Spirits of Turpentine* (Wilson Neil).—That which is used for mixing varnish ought to be procured and chosen as pure, strong, and free from acid as possible. Some turpentine being drawn from green trees abounds with a pyroligneous acid which rises and comes over with the spirit in distillation ; it is strong and bitter to the taste, and appears milky, particularly towards the bottom, after standing to settle. Therefore the longer turpentine is kept before it is used the purer and freer it will be from acid at the top of the cistern, as all its impurities will fall to the bottom and will be found unfit for any purpose in making varnish.

*Turpentine Substitutes.*—Attempts are made to replace spirits of turpentine by gasolene, benzol, petroleum ether, petroleum spirit and coal-tar naphtha, and by mixtures of these different solvents, etc., but except in certain particular instances their bad smell and their peculiar toxic effects, and last, but not least, their low flashpoint, entailing the danger of fire and explosion, have caused the use of the more volatile of these solvents or mixtures thereof<sup>1</sup> to be greatly

<sup>1</sup> Moreover, as each of the constituents of a mixture of different solvents may evaporate more or less quickly than the others, unequal drying results, with all its attendant evils.

abandoned, especially for inside work, whether on the interior of buildings on land or ships at sea or in dock.

It was left for the London County Council to put the Petroleum Acts in force against the makers of quick drying compositions into which gasoline entered, and that although the late Lord Abel had some ten or twelve years previously occupied the greater part of a long lecture with an account of the explosions caused by them. The scheduling of these low flash products is now regarded as a praiseworthy step, and the London County Council is to be congratulated on its action, the more so as the Employers Liability Act renders the dangerous use of such low flash material a risky job for the employer of labour. Properly used under their own name some such solvents have, however, many advantages, notably petroleum spirit, solvent naphtha and such-like, which dry quicker and are less tacky than spirits of turpentine, which seems to hug both resin and oil as long as it possibly can and only leaves them very unwillingly. These products have therefore a rational use, and it will be a pity if conformity to the letter instead of the spirit of the Petroleum Acts renders more drastic legislation necessary.

*Amber and Copal Oils.*—The deep brown oils produced along with succinic acid by the dry distillation of amber or copal have a density between 0·8 and 0·9 at 15° C. They are miscible with all the usual varnish solvents employed in the manufacture of oil varnishes, and may, it is claimed, be used to dissolve the softer copals without previous fusion. All that is necessary is to heat the finely-ground copal with the oil with constant agitation. But the harder copals do not yield a clear solution when treated in this manner unless they have been previously fused. Moreover, these “tacky” oils have a disagreeable smell which still further restricts their use in this direction. (They may, however, be refined as described on p. 19.)

*On the Choice of Driers used in Varnish-making.*—The driers hitherto used in the making of varnishes have been used without care or judgment in the most injurious manner, it being the common practice to introduce great quantities of red lead, common litharge, sugar of lead and foreign white copperas, raw Turkey umber, etc., without either considering the proper quality or quantity which have had the most injurious effects on the delicate colours upon which varnishes so made (or rather so spoiled) have been applied (Wilson Neil). Sugar of lead when bought for the purpose of adding to varnish as a drier ought to be that which has been made from white lead, and not that which has been made from litharge, that from white lead being the finest, and in its particles purer and transparent. All sugar of lead contains about 14·2 per cent. of the water of crystallisation, so that to use it in that state is very injurious to the varnish, as its water prevents that complete union of the particles of gum, oil and lead, which ought to combine instantly and form a whole; therefore, it is necessary to bruise the sugar of lead into powder, and lay it upon cartridge paper over a warm drying stove and

keep turning it and moving it about to prevent its running into a mass until it gradually dries ; it will then feel quite fine and soft, resembling hair powder ; afterwards sift it through a forty mesh sieve ; it is then fit for driers. Keep it closed up in a dry stone jar, until used, otherwise it will absorb moisture from the air.

*White Copperas or Sulphate of Zinc.*—The foreign article of this name, chiefly imported from Germany, is that which is generally used as a “drier” for varnishes, and in its undried state is more objectionable than the sugar of lead, because it discolours the varnish. Nearly all samples of commercial sulphate of zinc contains free acid. Such acid chars both the oil and gum in the varnish at a high temperature and injures the oil by affecting both its elasticity and durability. Another objection to its use in this state is that it requires the varnish to be kept for many months to settle, and if the varnish is not made very thin it will never get clear of the zinc near the bottom of the cistern. It is, therefore, necessary to bruise and dry it exactly as before directed for the sugar of lead. Sift and keep it from the air until the time it is wanted for use. This is the strongest and most effective drier when carefully dried and sifted, because varnish is then entirely freed from its watery particles whether from the oil gum or turpentine if a sufficient quantity is used. Such is its astringent and absorbent quality that if even water were mixed with the varnish the copperas would seize upon and carry it down to the bottom.

*Litharge* is to be chosen as free from earthy matter as possible, that which is from the richest and softest lead is the best and is termed “wind blown” or W.B. ; it is in large broad flakes or scales, appears very bright, skins and feels soft between the finger and thumb when rubbed, whereas the bad quality is distinguishable by an opaque, dull or earthy appearance and feels hard and gritty to the touch ; this ought always to be rejected, for it is easy to conceive the injury a mixture of impure lead and iron and impure earthy matters would occasion if introduced into varnish (see vol. i., pp. 84, 85).

*Red lead*, like litharge, ought to be chosen as free from earthy and extraneous matter as possible. A great quantity of red lead is said to be adulterated with earths, ochres, etc., therefore procure that which is most pure ; it is known from its strong, clear, bright colour, by its weight, or, if worth while, it may be easily analysed (see vol. i., pp. 85, 86). The best red lead is a strong and efficient drier when it can be used with safety.

*Turkey umber* has been and is still used by many as a drier. “I (Wilson Neil) like many others used it for years, but from experience found it contained nothing of a particularly drying quality, being (*sic*) only a mixture of clay, iron, vitriol, zinc, etc. I found it prevented everything from settling into which it was introduced for a length of time, and I therefore discontinued it. Its best quality is that of an absorbent. UMBER acts erratically owing to its variable manganese content.”

Varnishes are occasionally sold as guaranteed free from "rosin". No such varnish can be so warranted which contains a *rosinate* drier (vol. i., pp. 87-91). The mere fact that it is sold to the varnish-maker as a lead *resinate* does not alter the fact that a varnish made from it contains rosin. The real resinates have been made as follows:—

For the preparation of metallic resinates the chief resins used are rosin, white and red Angola copals, and yellow Benguela copal, and their acids are combined with lead manganese or zinc. The finely-powdered resins are heated with alcohol and soda lye, and the resulting solutions precipitated with acetate of lead or sulphate of zinc or of manganese. The precipitates are carefully washed and dried at low temperatures—30-40° C. As the yellowish-white manganese resinate oxidises rapidly in the air, and turns brown, it must be protected from atmospheric oxygen as much as possible.

In a first experiment hot pressed linseed oil was heated to 150° C., and the metallic resinate was then added gradually with constant stirring. In a second a temperature of 165° C. was used, and in a third 180° C., and in each case the temperature was maintained during the process. In other experiments the metallic resinates were treated with rectified turpentine of specific gravity 0.86, and boiling-point 160° C., and a temperature of 100° to 120° C. was employed. The solution obtained was mixed with linseed oil at 15-20° C., and then the whole was heated to 80-90° C. The results of these experiments are now given. A, B, C, D, E, F are rosinate from common rosin.

A. *Manganese Rosinate Boiled Oil*.—Two per cent. of the rosinate was used, and dissolved completely in linseed oil at 150° C. The solution was clear and of a light reddish-brown colour. When painted on wood or glass it gave a shining, transparent film on drying. The time of drying hard was twenty-eight hours on wood, thirty hours on glass at the ordinary temperature of the laboratory in the beginning of October, but in a warm room (18-20° C.) the time fell to twenty hours on wood and to twenty-four hours on glass.

B. *Lead Rosinate Boiled Oil*.—The solution was made as above, and was of a pale brownish-yellow and quite clear. It gave the same film on glass or wood as A, but dried more slowly, the corresponding time being: On glass, thirty hours and forty hours; on wood, twenty-four hours and thirty hours.

C. *Zinc Rosinate Boiled Oil*.—The solution, made as above, was clear, and its colour was brownish-yellow. The same films resulted as in the first two cases, and the drying times were: On glass, thirty-two hours; on wood, twenty-eight hours—both in the warm room.

D. *Manganese Rosinate Boiled Oil*.—Turpentine was used this time. The rosinate was first treated with the turpentine, and dissolved partially to a light brown liquid. This was then warmed with linseed oil, and gave a clear, pale, brownish-yellow varnish, which dried in all respects exactly like A.

E. *Lead Rosinate Boiled Oil*.—This was prepared exactly like D and the rosinate was, like the last, not completely soluble in the



turpentine. The film was exactly like that of D, but dried somewhat more slowly.

F. *Zinc Rosinate Boiled Oil*.—This was made like D, but the product was worthless.

G. *Boiled Oil from the Manganese Resinate of White Angola Copal*.—Two per cent. of the resinate was made use of, and did not dissolve quite completely in linseed oil, even at 180° C. The resulting varnish was yellow, and became clear after short standing. The films got with it were shining transparent, and firmly adhesive. The times in the warm room were twenty-two hours for wood and twenty-four hours for glass.

H. *Boiled Oil from the Lead Resinate of White Angola Copal*.—Two per cent. of the pure white resinate was used, and dissolved completely in linseed oil at 165°, but not at 150°. After a short period of standing the varnish was clear and yellow. The films resembled those of G, but were more brilliant and dried somewhat more slowly.

I. *Boiled Oil from the Manganese Resinate of Yellow Benguela Copal*.—The same quantity of resinate was used as above. It did not dissolve well at 160° C., but at 180° solution was practically complete without any frothing. The resulting varnish was pale yellow, and became clear after forty-eight hours' standing. The films were like those given by the Angola copal, but dried rather more slowly.

J. *Boiled Oil from the Lead Resinate of Yellow Benguela Copal*.—The 2 per cent. of resinate did not dissolve till a temperature of 180° C. was reached, and not without frothing. The yellow varnish cleared in forty-eight hours. The films were somewhat more brilliant than those of I, and took about three hours longer to dry.

K. *Boiled Oil from the Lead Resinate of Red Angola Copal*.—The same proportion of resinate as usual was employed, and dissolved in linseed oil at 165° without leaving much residue. The solution was yellow, and cleared in forty-eight hours. The films were brilliant and adhesive, and the drying time—in the warm room—was twenty-two hours for wood and twenty-four hours for glass.

It will be observed that all the preceding varnishes are made without turpentine. That body was used for all that now follow.

1. *Boiled Oil from the Lead Resinate of White Angola Copal*.—The resinate did not dissolve entirely in turpentine, even at 120°. The clear solution was poured off and warmed with linseed oil to 90°. A very clear pale yellow varnish resulted, which gave splendid brilliant films. The drying times—warm room—were twenty-four hours for wood and thirty hours for glass.

2. *Boiled Oil from the Manganese Resinate of White Angola Copal*.—The resinate did not entirely dissolve in the turpentine. The brownish-yellow solution, when heated to 90° with linseed oil, cleared in twenty-four hours and was a yellow. The films were just like those of No. 1, but took about two hours longer to dry.

3. *Boiled Oil from the Lead Resinate of Yellow Benguela Copal.*—The resinate was partly insoluble in turpentine. The solution, heated with linseed oil to 90° C., cleared in forty-eight hours and was pale yellow. The films were like the preceding, and dried in the same times as No. 1.

4. *Boiled Oil from the Manganese Resinate of Yellow Benguela Copal.*—The resinate began to dissolve in the turpentine at 50°, and at 120° was mostly dissolved. The solution was heated with linseed oil to 90°, and cleared in forty-eight hours and was of a light brownish yellow. The films were like those of No. 3, but dried about two hours sooner.

5. *Boiled Oil from the Lead Resinate of Red Angola Copal.*—The solubility of this resinate in turpentine is the same as that of the latter. The turpentine solution was heated to 90° C. and cleared in forty-eight hours. The solution gave films which resembled those of No. 1.

The boiled oils A and B made with cold pressed oil were the most pale, but whether the oil be pressed cold or hot does not affect the drying or the character of the films. The oil itself dried in seventy-two hours on wood. When poppy oil was mixed with the linseed oil the brilliancy of the films was enhanced, but they dried more slowly. The drying of the metallic resinate boiled oils is quicker if they are kept for about a month at ordinary temperatures without being used. In the case of the boiled oils B and I the difference thus produced was two to three hours. It was also found that 1½ per cent. of resinate answered fully as well as 2 per cent. These experiments show that the metallic resinate boiled oils are best made without turpentine. The labour is slight and the time short, and as solution is more perfect than with turpentine the yield of varnish is greater. The use of turpentine entails more waste and requires greater care and takes longer. The insolubility in turpentine is, however, lessened if ozonised turpentine is used. With regard to drying power the metallic resinates seem fully equal to ordinary boiled oil. Comparison was made between five boiled oils made in this respect: (a) A manganese borate boiled oil dried hard on wood in forty-eight hours; (b) a so-called ozonised linseed oil took forty-six hours to dry; (c) an ordinary boiled oil with litharge took seventy-two hours; (d) a double-boiled manganese boiled oil took thirty hours on glass; (e) a colourless photographic copal varnish took twenty-eight hours on glass.

*Additional Hints.*—1. The quality of a varnish depends principally upon the hardness of the resins used, but a difficulty is met with in the very beginning. The hard resins do not dissolve directly and at once in the solvents used, and they in particular refuse to dissolve in boiled oil or spirits of turpentine. It has been pointed out, when describing the properties of the raw materials used, that it was necessary to render these hard resins soluble by previously heating them to a rather high temperature. It is therefore necessary to modify

the manufacturing process according to the manner in which the resins used behave when treated with different solvents.

2. *Varnishes made from Resins which do not Dissolve Directly : Amber and Copal Varnishes. Addition of Oil to Melted Resin.*—The process most generally used consists in melting the resin in a copper vessel on the naked fire, and then to afterwards add first the oil and then the spirits of turpentine in suitable proportions. Without going into detail in regard to the fusion of the resins, which has already been dealt with at some length (p. 97 *et seq.*), it must be borne in mind that the pot ought to have a capacity double that occupied by the resin used, so that there may be no risk of the material priming over, especially when it contains much water. If some authorities claim that it is better to work with small quantities at a time, say 3 to 5 lb. at the most, so as to obtain as pale products as possible, which cannot be done when 25 to 35 lb. or even 100 lb. are "run" each time, the time occupied in working with small quantities being more than compensated for by the paler product, yet others assert more *pro rata* charring must perforce occur with small than with large quantities owing to, they allege, greater *pro rata* heating surface contact.

Finally, copper pots must be used, because it is necessary to heat to 300° C., and at this high temperature copper has more resistance than iron. When the fumes cease, and when the resin is about fluid, the varnish-maker "sounds" the varnish with his spatula, which should be made of iron, because wooder spatulas, besides darkening the varnish by charring, contain moisture and give rise to boiling or frothing, which may mask the fluidity. When the resin is completely melted and fluid it runs from the spatula in drops like water. The resin if not completely fluid on the addition of oil yields a turbid viscous mass, or the spirits of turpentine separates the resin in a viscous lumpy aggregation. When treating certain copals containing or liberating much moisture it is better to let the resin remain on the fire for two or three minutes longer, after it has been melted, so as to drive off all trace of water, etc., otherwise, although a clear product would be obtained on the addition of linseed oil, it would become turbid on the addition of spirits of turpentine.

3. *Varnishes, the Resins of which Dissolve Directly in the Solvent without Previous Fusion.*—The manufacture of varnish becomes very simple if the resin dissolves directly in oil. Solution is effected on the water bath and afterwards adding the spirits of turpentine. The resin ought to be ground as finely as possible and beaten up with a little cold oil; this mixture is added to the bulk of the already heated oil, the whole is stirred continually and the heating continued until complete solution is effected. If the resin does not dissolve easily in oil, shellac, sandarac, etc., or if it is desired to accomplish solution more rapidly, an intermediate solvent may be used. Again substances like india-rubber and gutta-percha may be dissolved in an appropriate solvent such as benzol, spirits of turpentine, ether,

etc., and the resultant solution added to the oil or to an oil varnish made from a hard resin, *provided such solution remains permanently dissolved therein.* This addition may be done hot or cold according to circumstances, and the whole may afterwards be thinned down with spirits of turpentine. This process may, it is said, be employed with certain hard copals. When it is desired to make varnish from

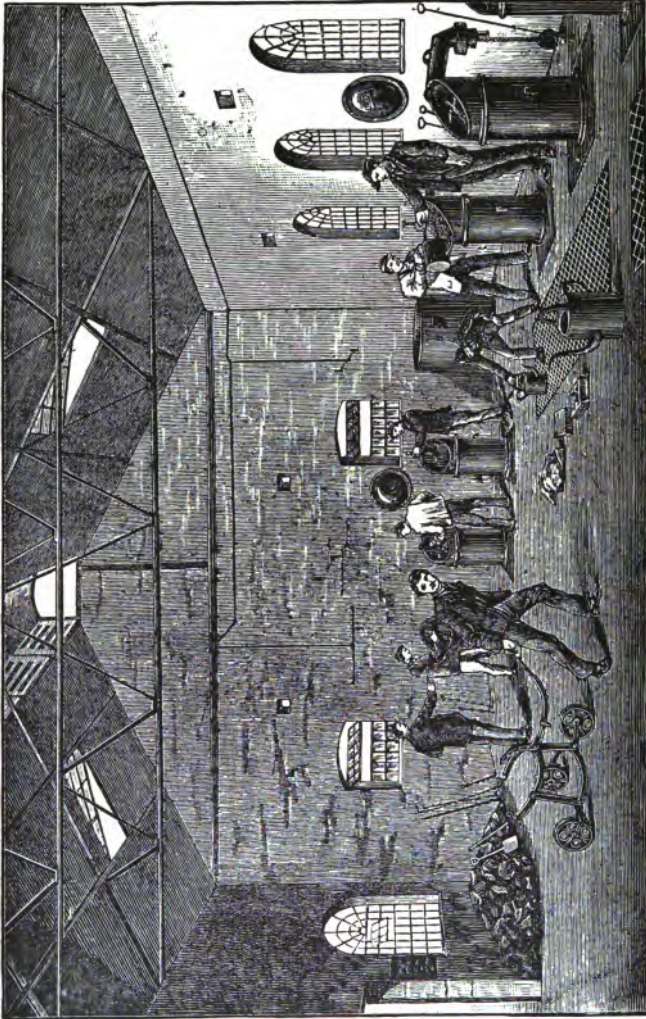

FIG. 37.—An English Copal Varnish Factory.

a mixture of hard resins and resins directly soluble, these latter may be added to the copal or amber in the melting pot and the whole poured into hot linseed oil, thinning down afterwards with spirits of

turpentine. Finally, certain difficultly soluble resins may be coaxed to dissolve by adding to them certain resins which dissolve easily. This is the case, for example, with Kauri to which *dammar* has been added. We may recall the direct addition of liquid driers to linseed oil.

4. *Incorporation of Linseed Oil.*—The raw oil is heated separately, and added to the fluid resin, whilst stirring constantly. Some manufacturers allow this mixture to cool, mostly in the case of oil, which has been previously boiled with driers, but in general it is preferable to heat it for some time, so as to bring it to the proper consistency or body. To prevent fire the temperature should not exceed 300° C. (572° F.). The process is often modified by running a certain number of potfuls of the mixture of fluid resin dissolved in oil into a large pan which is heated to and kept about 140° C., 284° F., until the oil has become sufficiently thick, and



FIG. 38.—A Continental Copal Varnish Factory.

formed an elastic substance which imparts such suppleness and flexibility to the varnish that the expense and the increased length of the process are more than compensated.

5. *Stringing.*—The heating should be continued until the varnish, when spotted on a glass plate, yields a bright transparent product possessing the greatest possible consistency and capable of being drawn into long elastic threads which do not break easily. Each drop falling on the glass plate should form a decided arch. This result is obtained by prolonging the heating process in proportion to the thinness of the mixture at the beginning, the more oil it contains the longer the process.

6. *Incorporation of Spirits of Turpentine.*—Whether working with a single pot or with a pan into which several potfuls have been emptied, the mixture is allowed to cool to 160° to 170° C., that is

to about the boiling-point of spirits of turpentine, and the solvent, *i.e.*, spirits of turpentine, is slowly added, preferably from a jug with a long neck or spout, in a small stream and in small quantities at a time. About  $\frac{1}{10}$  part of the solvent is added in the beginning and half that quantity each time afterwards, sampling after each addition. So long as the liquid maintains a certain viscosity on cooling and thickens rapidly, the addition of spirits of turpentine is continued. But when the consistency diminishes greatly on the addition of a small quantity of spirits, the limit has been reached and no more must be added, otherwise the quality of the varnish will be injured. Often the spirits of turpentine or other thinner must be added in a continuous stream and without intermission, as in the interval the mixture may chill and all the resin be thrown out of solution. It is well to work with warm but not too hot turpentine when dealing with certain tricky resins and pitches like bone pitch.

7. *Filtration and Clarification.*—Varnishes after manufacture and before being used ought to be filtered and clarified to separate the smallest impurities which would seriously depreciate its value by preventing it from drying with a uniform surface. The loss entailed by these operations may amount to 1 or 2 per cent. according to the quality of the resins used. Filtration is effected by running the hot varnish through coarse linen or fine tulle. There is no advantage in using metallic sieves; they are dear, are easily pierced, and can only be cleaned with difficulty.

Clarification is effected by prolonged storing of the varnish in a warehouse kept at a moderate temperature and preferably in semi-darkness during a period of not less than eight days. Under these conditions all impurities, even those of extreme tenuity, are deposited. In England, high-class varnishes are allowed to deposit for several months. The clarified varnish is decanted and the residue is filtered through hot filtering plant. If the cooled varnish after standing appears to be too thick, it must not be diluted by the simple addition of spirits of turpentine, but be thinned by adding spirits of turpentine well mixed in the hot state with a certain quantity of the cold varnish. If, on the contrary, the varnish be too thin, it is reheated to drive off the excess of solvent or a thicker varnish is added to it.

8. *The Mechanical Filtering of Varnish.*—Schweizer's filter consists of the cylinders I, II, III, IV, about 8 inches high, of strong sheet copper varnished internally with amber varnish. They are screwed up together by their flanges by aid of the clamps as shown so as to form one single air-tight chamber. A funnel is fastened to IV with an outlet tube, and I, the top cylinder, has a funnel-shaped lid, the apex of which connects by means of a pipe with the copper cylinder V from which the liquid is fed into the filter, the flow through the pipe being regulated by the tap H. The liquid to be filtered enters V through the funnel F. Air can be pumped into V through the

pipe L, the funnel F being shut off by the tap. A somewhat tightly woven cloth is stretched between I and II, and these are then clamped together. III is now clamped on and then IV. A plate of cellulose about  $\frac{1}{4}$  of an inch thick is interposed between two cloths between IV and the funnel C. As soon as the cylinders are all fixed up and everything arranged the tap H is opened and the liquid to be filtered fed into the filtration apparatus. As the liquid to be filtered has to pass through the three tightly woven cloths stretched between the cylinders, the roughest of the impurities collect on the top cloth and only particles of a finer grist on those beneath, whilst only an almost clear solution reaches the layer of cellulose. When the filtration becomes sluggish L is put in connection with a pressure pump and pressure applied if need be up to 5 or 6 atmospheres. But so long as the liquid runs regularly the pressure is not increased. On



FIG. 39.—Schweizer's Varnish Filter.

undoing the clamps and dismantling the apparatus the cloths are found to be covered by a resinous slime of undissolved resin from which they are freed by steeping them in the solvent. The cellulose plate is treated in the same way when its pores eventually become clogged by a very fine deposit. No oil varnish filter, however, will work in cold weather which is not steam jacketed or capable of being heated somehow. Although at first sight Schweizer's filter appears designed to work satisfactorily it must perforce fail on this account

alone, and a pressure pump is not likely to act as anticipated. Clarification by aging and deposition is not likely to be superseded in the oil varnish trade, and it would be folly to anticipate the deposition on aging by prior filtration. Those who think otherwise, however, might find the mechanical filters used in sugar works available for this purpose (see *Technology of Sugar*, Scott, Greenwood & Son).



## CHAPTER VII.

### COPAL OIL VARNISH.

OIL varnishes made from hard copal have a remarkable lustre, very great transparency, and are distinguished for their elasticity. They are specially adapted for prized articles decorated with fine delicate oil colours; upon white polished surfaces they look like glass. The beautiful hard copals of the east and west coast of Africa yield very bright pale varnishes because they contain very little foreign organic matter to blacken on fusion. The oil varnishes from the semi-hard copals are more brilliant than the preceding, a fact due to their melting-point being lower; they are generally but slightly coloured except in the case of certain Asiatic copals, which contain a notable proportion of foreign organic matters which carbonise on fusion; they are less durable and resistant. A good copal varnish ought to be thick, of a bright golden yellow colour; it ought to spread easily and without striæ, and to dry completely in six or seven hours. In treating of the manufacture of oil varnishes in general, different processes for making copal varnish have been described, and it is therefore unnecessary to refer further to them here except to indicate very special processes, such as that due to Andres, for the manufacture of a colourless varnish.

*Andres' Colourless Copal (Oil) Varnish.*—Andres pulverises Indian copal very finely and dries in an air bath at 120° C. for several hours. To this powder there is then added its own weight of ground glass or very dry quartzose sand. Enough chloroform or petroleum ether is poured on the still hot mixture to cover it, and the whole allowed to stand in a well-closed flask for twelve hours. In contact with the chloroform the copal swells greatly, and becomes more apt to dissolve in other solvents. The contents of the flask are then run into a pan T closed by a lid A provided with an agitator, heated on the water bath K and furnished with a delivery tube B, connected with a serpentine condenser C. The necessary quantity of spirits of turpentine is added and the water bath gently heated, so that the vapours of chloroform condensed in the serpentine C fall back into the pan. After heating for half an hour to one hour the solution of the copal is sufficiently advanced, and the petroleum ether or chloroform is distilled off. They are recovered without loss in a pure state, as spirits of turpentine does not volatilise at this tem-

perature. Heat is continued from thirty to forty minutes to cause the turpentine to boil and dissolve the copal. On the other hand, raw linseed oil as pale as possible is heated on the water bath to 100° C., and rendered drying by borate of manganese. The previous solution of copal in spirits of turpentine, cooled to 60° to 70° C., is ladled into the oil, stirring after each addition. The heat is withdrawn, agitation is kept up for twenty minutes, and then the varnish is run into large flasks. It is very pale and bright, and soon clarifies completely. This varnish is colourless when dry, for the oil when well made bleaches completely as it oxidises. Moreover, there is no tendency to pinhole, etc., but it takes about twenty-four hours to dry.

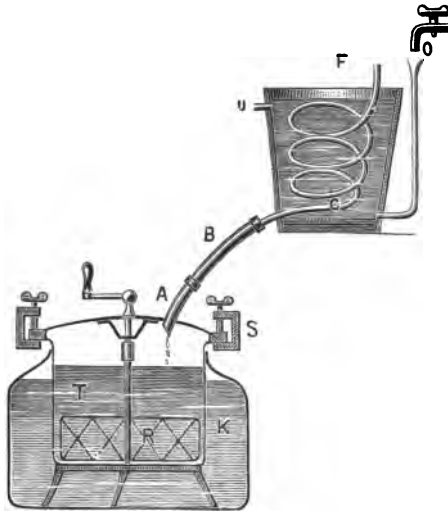

FIG. 40.—Andres' Process for making Pale Copal Oil Varnishes.

*Violette's Process.*—Very pale and very durable varnishes from hard fused copals may be made by Violette's process by replacing the boiling process by simply heating by means of a steam coil in which water at 100° C. circulates the mixture of oil and spirits of turpentine into which the copal dips by means of an arrangement described on pp. 145, 146 when treating of dissolving resins in closed vessels. The temperature of the process may vary between 190° C. and 140° C. according to the quantities operated upon. If the temperature be too high there is considerable loss of spirits of turpentine by volatilisation, but on the other hand, if the temperature be too low the incorporation is effected badly or not at all. The essence is generally heated so as to avoid too sudden cooling of the mixture, and in this case the mixture of resin and oil may be brought to a lower temperature than when the spirits of turpentine is added in the cold, thus greatly diminishing the disengagement of vapour on

the addition of the latter. With ordinary good working the loss of spirits of turpentine is about 5 per cent., but it may rise as high as 10 per cent. if the temperature be too high.

*Addition of Resin to the Oil.*—This process, due to Tingry and Andres, requires the adoption of special plant (Figs. 26 to 31), the working of which has already been described in the chapter devoted to the influence of heat upon the solubility of resin. The melted resin falls drop by drop into a vessel (K, Figs. 27 and 29) containing the oil, heated to a suitable temperature; solution takes place as soon as it drops into the hot oil, producing a homogeneous product. But the process presents many difficulties, the principal one being the risk of fire from the inflammation of the vapours.

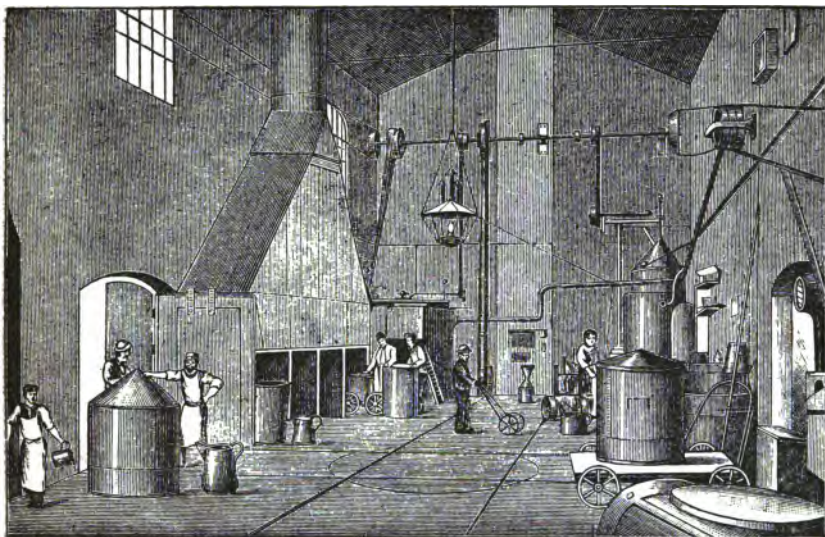

FIG. 41.—Mixing Room of an English Oil Varnish Factory.

*Mixed Process.*—The manufacture of oil varnish in certain English factories is based upon the two previously described processes. Nine parts by weight of oil are heated in a pan almost to boiling, and  $\frac{2}{3}$  of it are taken out and put into flagons, each containing  $\frac{1}{3}$ . These flagons are placed on the plate of the furnace and kept at a good heat. On the other hand, 1 part of copal is fused in the gum-pot in the ordinary manner, and when the copal is completely melted and runs like limpid oil the contents of one of these flagons of oil is added, *i.e.*,  $\frac{1}{3}$  of the total oil. When the mixture is complete the whole is run into the boiling pan which contains the rest of the hot oil, kept at a sufficiently high temperature. The melting pot is cleaned with a brush or a cloth rag previously dipped in spirits of turpentine, and 1 part of copal is again melted in it, and at the proper moment the

contents of one of the two remaining flagons of oil added, the mixture is run into the boiling pot, which has already received the mixture resulting from the first fusion. The same operation is gone through with another part of copal, to which is added the contents of the third flagon of oil. Working in this way, after having first mixed the oil with the resin and then added the resultant mixture to the oil in the boiling pot, there will in the end be in the latter 3 parts of copal and 9 parts of oil, which is placed over a good fire and maintained at a rather high temperature, taking care, however, to remove the boiling pot from the fire if at any time it threatens to boil over. The driers are now added in successive small quantities, with continuous stirring. The time necessary to bring the three successive

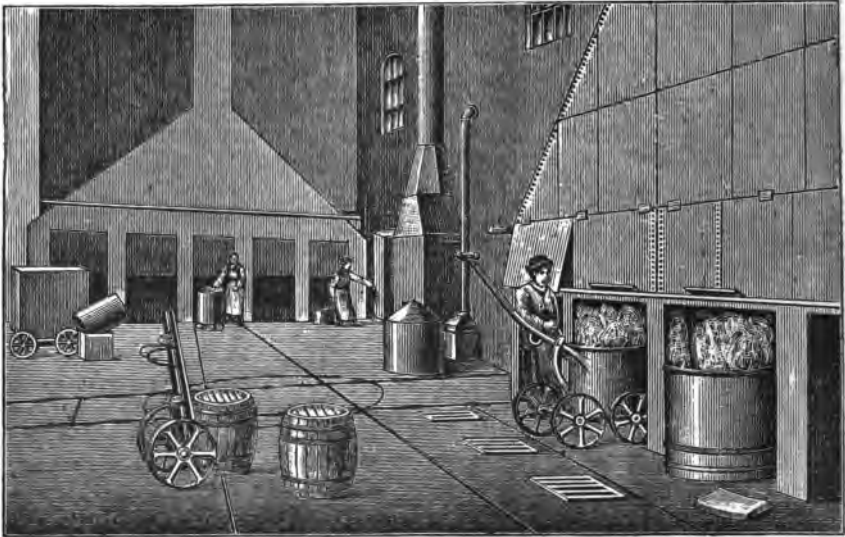

FIG. 42.—Another Mixing Room of an English Oil Varnish Factory.

“runs” to the desired condition varies from three and a half to four hours, when a sample is taken and placed on a glass plate. It ought to give a clear, homogeneous, transparent mass, which strings into elongated filaments when pressed between the finger and thumb, and these afterwards extended away from each other. If it does not string the boiling must be continued. The pot and contents are withdrawn from the fire, and when sufficiently cool a sufficiency of spirits of turpentine is added, the quantity varying from 13 to 17 parts, according to the hardness of the copal and the success which has attended the fusion. The operation finished, the boiling pan is emptied and cleaned as before with the spirits of turpentine which had already served to clean the melting pot.

This process, which would appear to give very good results, is

applicable to large quantities, certain factories working in the melting pot a mixture of oil and copal of about 70 lb. in weight. Further, sometimes the contents of ten of these pots are mixed in the boiling pot, which is mounted on a movable truck and placed on a furnace. Seven hundred lb. of oil and copal are thus boiled at one operation; manganese driers are used to the exclusion of lead;  $\frac{1}{4}$  lb. of borate of manganese is used for every 100 lb. of oil. The whole is boiled for half an hour. Figs. 37, 41, 42 and 43 will give some idea of modern English methods. The fumes ascend through the hood and pass along the conduit to the chimney shaft.

*Hot Solution in Closed Vessels of the Previously Fused Resin.*—Attempts have been made to get better results by dissolving the previously fused resin in a hermetically sealed vessel at the lowest

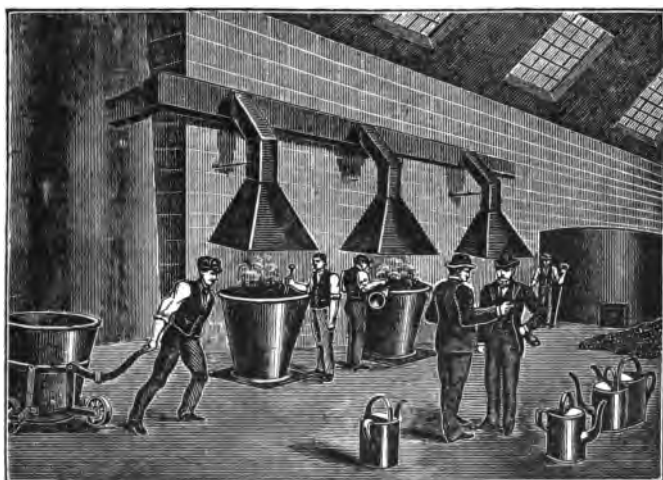

FIG. 43.—Manufacture of Super Black Japan in an English Varnish Factory.

possible temperature to avoid loss of raw material and risk of fire. Bartky breaks up the previously fused resin and heats it with the oil, at first to  $80^{\circ}$  and then to  $150^{\circ}$  C. The pan is then covered with a lid which hermetically seals it. Through the lid there passes an agitator, which is kept in motion for about an hour, the temperature is allowed to cool down to  $100^{\circ}$  C., the agitation being still kept up; it is then reheated to  $130^{\circ}$  C., then allowed to fall to  $110^{\circ}$  C., and by an opening inserted in the lid the necessary quantity of spirits of turpentine is introduced.

The pans shown in this treatise (Figs. 17 and 18, vol. i.) with safety valves are suitable for this class of work. The apparatus shown in Fig. 44 designed to work in conjunction with Fig. 30 might also be used. Superheated steam enters the jacket C' through D and escapes as condensed water at W. O is the charging manhole for

solids, L the charging funnel for liquids. The agitator is driven by the bevelled cog-wheel gearing K. The finished varnish is run off by the pipe and tap to the left; but an apparatus for working with superheated steam should be fitted with a safety valve, as in Bartky's apparatus which consists of a copper receiver placed inside a wrought-iron boiler, leaving an annular space of about 10 inches through which superheated steam circulates. The cylinder and the boiler are provided with safety valves and manholes, and a mechanical agitator for stirring the resins, which are afterwards run off through a tube at the bottom. The condensed steam is run off through a tap.

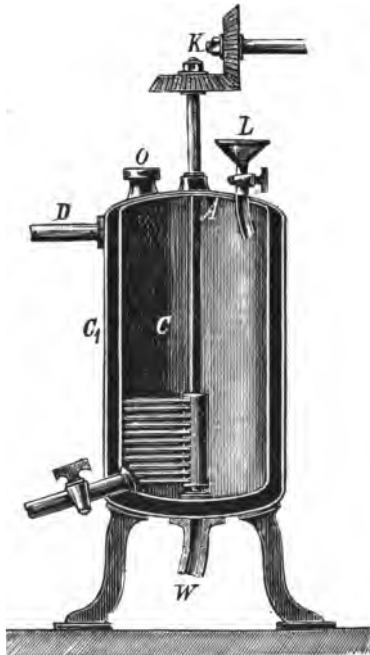

FIG. 44.—Closed Pan for making Oil Varnish by dissolving previously fused Resin in Linseed Oil by Superheated Steam.

*Andres' Process.*—Andres works somewhat similarly, *viz.*, by solution in a closed vessel but at a lower temperature. The boiler F which he uses is placed in a water bath K, and is furnished with a lid D which dips into a hollow flange or circular gutter affixed to the circumference R; by filling this hollow with oil the boiler is hermetically sealed, except so far as to allow of the escape of vapour. About two-thirds from the bottom is a ring shelf C, upon which rests a metal box with a perforated bottom in which the previously fused resin is placed.

The boiler F being filled with oil and the water bath K started there is added to the oil  $\frac{1}{2}$  of the copal to be used to which its own weight

of oil of copal, oil produced during the fusion of the resin, has been added. The remainder of the copal is then placed in the interior receptacle and the necessary quantity of spirits of turpentine added, taking care that the copal is immersed for about 4 or 5 inches.

The lid being placed on the boiler, all that has to be done is to heat the whole at 100° C. (212° F.) for three or four hours to effect complete solution. The contents are run off through a pipe A in the bottom, taking care to place a cloth in front of the orifice so as to secure easy filtration of the hot varnish.

The principal advantages claimed by Andres for this method are economy in fuel and working expenses, as the work is done without stirring. Moreover, there is no risk of fire, no loss of spirits of turpentine, and finally, there is obtained a very pale varnish due to the low temperature at which the process has been conducted by heating all the ingredients together in closed vessels.

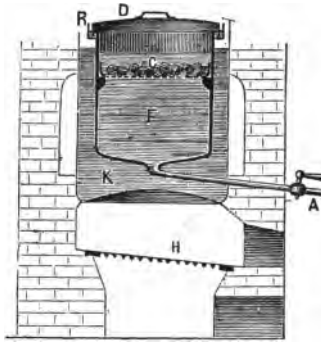

FIG. 45.—Andres' Apparatus for dissolving previously fused Resins in a mixture of Linseed Oil and Turps.

*Solution in the Cold of the Previously Fused Resin.*—Attempts have been made to simplify the operation of varnish-making by using previously fused resins and dissolving them directly in the cold in a mixture of oil and spirits of turpentine. The resin may be dissolved in the ordinary manner or in a closed vessel.

Solution in the cold sometimes yields a turbid varnish, but this is simply due to the presence of water which may be allowed to escape before sealing the vessel, or may be driven off by heating the varnish to 100° C. This cold process ought to attract the attention of manufacturers. It is easily wrought and there is no loss of spirits of turpentine. Besides, if previously fused resins be bought all risk of fire is done away with, and the process has the further advantage of producing very pale quick-drying varnishes with great fluidity if an oil the drying properties of which have been stimulated by being subjected to one of the cold processes previously described. In particular, if we employ an oil treated in the cold with precipitated lead and a salt of manganese, the proportion of spirits of turpentine may be largely diminished, this oil having preserved its original fluidity even

whilst acquiring intense dry powers, and the varnish into which it enters after drying will have great elasticity.

*Simultaneous Solution of Raw Resin Oil and Solvent in Closed Vessels (under Pressure).*—So far back as 1846 Schutzenberger suggested the heating of the three ingredients (solvent, unchanged resin and oil) in a closed vessel. The operation lasted two hours.

In 1856 Violette took the matter up and claimed that perfectly pale varnishes could be obtained by this method and without loss of raw material. Although this process does not appear to be adopted in actual practice, it is as well to bear it in mind, because it is probable that owing to the great improvements and developments which have been effected upon plant working under pressure, it may be generally adopted in the near future. Certain methods of solution have also been tried based upon an observation of Violette, *viz.*, that amber and copal which melt at 350 to 400° C. melt without loss in weight at 100° C. in closed vessels, in consequence of a new grouping of molecules. Experiments made with finely pulverised resins in hermetically sealed apparatus have afforded interesting results, but up to now this mode of working has not been adopted on the large scale. Moreover, foolhardy and inexperienced persons run great risk in working or experimenting with plant of this description.

*Fusion of Resins in Closed Vessels.*—When solution is effected in closed vessels the product is not darkened in any way, and there is no loss if a suitable temperature be used. *Violette has claimed that hard resins, like copal and amber, after fusion in closed vessels have the property of dissolving either in the hot or in the cold in the usual solvents, and particularly in spirits of turpentine and oil.* Violette wrought with silver-plated copper tubes capable of being hermetically sealed. In this tube, which measured about 20 inches in length, 2½ inches in width, and about ⅜ of an inch thick, he heated about 2¼ lb. of resin.

With regard to colour, the temperature varies according to the resin used. Calcutta copal melts below 315° C., the hardest copals at 350° C., and certain ambers at 400° C. The tube should be made in such a manner that when opened the small quantity of gas disengaged during the melting may escape without danger. *No inexperienced person should attempt to work with sealed tubes. The risk is great, and explosions, not only during the time they are being heated, but also on opening them, are much to be feared.*<sup>1</sup>

*Smith's Experiments on Fusing Resins under Pressure.*—Smith claims to have succeeded in running copal in glass vessels under a

<sup>1</sup> The author has known university graduates doing research work to heat mixtures of highly volatile fluids in sealed tubes in an oil bath which consisted of a soldered tin pan! To work in that way is to court inevitable disaster, and such procedure on the part of those whose training ought to teach them better is lamentable. The moral is, however, not to put any one, whether a graduate or not, on to research work before he has at least learned the melting-point of common solder, and that oil can be heated to a much higher temperature than water before it "boils"; in other words, that "boiling" oil melts common solder while boiling water does not.



pressure of 2 atmospheres in such a way that the resin was rendered soluble in turpentine and linseed oil without loss, and gave thereby a usable varnish. He, however, gave no credit neither to Schutzenberger nor to Violette, but seems to claim novelty for his ideas as he patented them. One hundred grammes of Kauri copal was powdered, and in their air-dried state dissolved under 2 atmospheres pressure in 200 grammes of linseed oil. The solution required the large amount of 530 grammes of oil of turpentine to give it the necessary thinness for the brush. This amount of oil of turpentine is roughly double what would have been wanted if the copal had been run in an open vessel. But as will be pointed out by-and-by, copal dissolved in linseed oil by heating in a closed tube is precipitated by

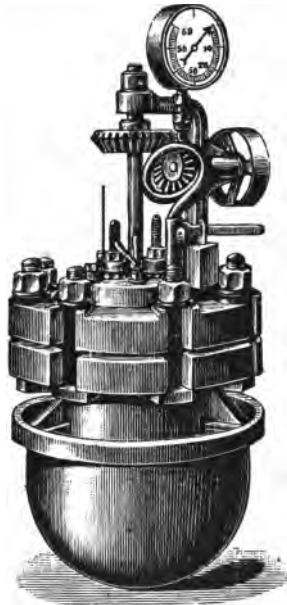

FIG. 46.—Autoclave for dissolving Resins under Pressure (Dietrich).

a little oil of turpentine, so that the large excess used by Smith was possibly required to redissolve it. It is probable that the varnish loses in quality what it gains in quantity. In order to test Smith's results in a practical manner, copal was placed in small pieces by itself in a beaker (to prevent it coming in contact with iron), and the beaker was placed in a small cast-iron digester intended for 100 atmospheres pressure and tested by water pressure up to 300 atmospheres. It was found impossible to get a pressure above 25 atmospheres on account of leakage of gas. At that pressure the temperature was 250° C. All the experiments showed that the copals assumed a balsamic consistency. Manilla copal, for example, after long exposure to a pressure of 15 atmospheres at 205° C., was a thick, brown syrupy mass in the beaker. Outside the beaker there was a lighter oil. The mass

dissolved in turpentine and linseed oil but gave no usable varnish. Rosin heated to 180° C. under 13 atmospheres pressure gave a balsamic mass smelling strongly of rosin oil. Zanzibar copal heated under 14 atmospheres pressure evolved quantities of gas which streamed on to the digester, and formed a balsamic mass which could be made into a clear varnish with turpentine, linseed oil, and siccativ. This varnish dried after a fashion, but was very inferior. Former researches have shown that Zanzibar copal hermetically sealed in glass is not fused even at 300° C., and the experiments under notice show that the longer heating given at a lower temperature causes much decomposition of the copal. Kauri chips were heated to 200° C., under 22 atmospheres pressure. A colourless combustible gas of curious odour escaped, and the residue was a dark brown oil of disagreeable smell. This was a mixture of various bodies and had a specific gravity of 1.0025 at 19½° C. It dissolved in chloroform, acetone, oil of turpentine, oil of camphor, benzole, and carbon-bisulphide, and partly in alcohol and amyl alcohol.

*Lippert's Researches on Fusing Copals under Pressure.*—The fusion of copals is to render them soluble in (a) linseed oil and (b) spirits of turpentine and other volatile resin solvents, thereby rendering them fit for the manufacture of varnishes. The loss during the process varies with the nature of the copal, from 25 to 50 per cent. (partly gas and partly copal oil). The copal oil can be collected, but is a by-product of small value, so that attempts to improve the process of copal-running should take the form rather of restricting the loss as much as possible than of recovering any portion of it. Violette and Prechtl have to this end investigated the effect of heating the copal in closed vessels. Violette used a sphere and a copper tube silvered inside, while Prechtl employed an apparatus resembling a stuffing box, applying the pressure by a weighted safety valve. Violette's results, says Lippert, are self-contradictory. At one time he says that a temperature of 350° C. had to be maintained for from fifteen to twenty minutes (for what kind of copal is not mentioned), and at another he says that copal and amber, which, under ordinary circumstances, fuse at from 350° to 400° C., melted in closed vessels at 100° only, adding, "This property which the copals acquire by a simple fusion in closed vessels must depend upon a molecular arrangement, for no loss of weight can be observed". Again, he uses high and low temperatures indiscriminately. He estimates the pressure he got at 20 atmospheres. The copals and amber after treatment dissolved at once in linseed oil and oil of turpentine, and varnish could be made right off by heating the copal and the solvent under pressure together. Violette and Prechtl are silent as to the quality of this varnish. The following experiments were made by Lippert: 10 grammes of very pale hard Manilla copal were kept in a closed glass vessel for a long time at 100° C. No fusion took place, and the temperature was then raised to 180°. The copal then melted to a pale yellow mass full of bubbles. When the vessel was opened there was evi-

dence that the pressure inside was only small. The bubbles, which Violette also observed, are caused by water, and disappear on heating with linseed oil, but the mass could not be brought into solution, and on cooling formed an opaque solid substance separate from the oil. In the next place three closed glass vessels, one with 10 grammes of Kauri copal, one with 10 grammes of Zanzibar copal, and the third with the same weight of white Manilla copal, were heated to 300° C. for a few hours. The Kauri copal was then a pale, fused, transparent mass, with a tallowy crust and a few drops of water. The pressure was considerable. The copal dissolved with frothing when heated in linseed oil, and the water volatilised. On the addition of turpentine to the solution a pale varnish was obtained, which would bear a little siccative, but was precipitated by more. When the varnish was cold, too, the copal precipitated, and could only be kept in solution by the aid of heat. The Manilla being a more fusible copal than the Kauri had been, as might have been expected, overheated, and was very much darkened in colour. It yielded with oil, etc., a varnish of the same properties as that just described. The Zanzibar copal was practically unchanged, but had acquired an aromatic smell. These experiments show that copals do not fuse at 100° C. in closed vessels, and want as high a temperature as they do in open pans. Besides, the copals heated under pressure give unusable varnishes, which can only exist while hot.

*Recipes.*—The proportions of the ingredients of copal oil-varnish vary with the nature, quality and species of copal used and the purpose for which they are to be employed, *i.e.*, with the nature of the object to which the varnish is to be applied. The greater the relative amount of oil entering into the composition of the varnish the greater will be the elasticity, but the oil added should dry to a very elastic layer after oxidation, and to secure this the best results are said to be obtained by boiling slowly for a very long time, if need be for several days, without adding drier and at such a temperature that the oil does not darken. It is only after the varnish is made that a small quantity of liquid drier is added. The proportions of the raw materials used in making copal varnish may vary between the following limits:—

TABLE XVIII.—SHOWING RELATIVE PROPORTIONS OF INGREDIENTS IN MANUFACTURE OF COPAL VARNISH FROM HARD AND SEMI-HARD COPALS.

| Ingredients.       | Outdoor Decoration. | Indoor Decoration. | Carriage Decoration. | Very Elastic. <sup>1</sup> | Less Durable.    |
|--------------------|---------------------|--------------------|----------------------|----------------------------|------------------|
|                    | lb.                 | lb.                | lb.                  | lb.                        | lb.              |
| Hard copal . . . . | 100                 | 100                | 100                  | 100                        | 100 <sup>2</sup> |
| Raw oil . . . . .  | 30-80               | 25-50              | 150-200              | 250-350                    | 16-80            |
| Turps . . . . .    | 130-240             | 250-300            | 100-150              | 130-360                    | 230-250          |

<sup>1</sup> Adapted for japan work that has to be wrought after being stoved.

<sup>2</sup> Semi-hard copal this type is mainly used for indoor work; the proportion of linseed oil varies with the hardness of the copal.

TABLE XIX.—SHOWING RELATIVE PROPORTIONS OF INGREDIENTS IN MANUFACTURE OF COPAL VARNISH FROM ZANZIBAR COPAL.

|                     |     |     |     |                   |     |     |     |
|---------------------|-----|-----|-----|-------------------|-----|-----|-----|
| Copal, W.A. . . . . | lb. | lb. | lb. | Copal, W. . . . . | lb. | lb. | lb. |
| Raw oil . . . . .   | 100 | 100 | 100 | Raw oil . . . . . | 100 | 100 | 100 |
| Turps . . . . .     | 200 | 150 | 75  | Turps . . . . .   | 150 | 120 | 100 |
|                     | 350 | 375 | 300 |                   | 350 | 410 | 300 |

TABLE XX.—SHOWING FOR EVERY 100 LB. OF WEST AFRICAN COPALS HOW THE AMOUNT OF RAW OIL AND TURPS USED IN MAKING VARNISH THEREFROM MAY BE VARIED TO MEET END IN VIEW.

| Copal.             | Turps. | Raw Oil. | Copal.                 | Turps. | Raw Oil. |
|--------------------|--------|----------|------------------------|--------|----------|
|                    | lb.    | lb.      |                        | lb.    | lb.      |
| Angola . . . . .   | 200    | 350      | Glass . . . . .        | 100    | 270      |
|                    | 150    | 300      | Sierra Leone . . . . . | 180    | 340      |
|                    | 110    | 280      |                        | 130    | 280      |
| Benguela . . . . . | 190    | 360      |                        | 110    | 280      |
|                    | 140    | 300      |                        | 170    | 330      |
|                    | 100    | 270      | Benin and White Angola | 130    | 280      |
| Pebble . . . . .   | 180    | 360      |                        | 100    | 270      |
|                    | 150    | 310      | Accra . . . . .        | 170    | 340      |
|                    | 100    | 270      |                        | 140    | 290      |
| Glass . . . . .    | 190    | 360      |                        | 100    | 270      |
|                    | 140    | 290      |                        |        |          |

Working with boiled oil and dissolving the fused resins therein the solvents may be varied as follows for each 100 lb. of Angola, Benguela, Pebble, Sierra Leone and Benin:—

|             |        |
|-------------|--------|
| Boiled oil. | Turps. |
| 80          | 250    |
| 60          | 250    |
| 40          | 240    |

TABLE XXI.—SHOWING FOR EVERY 200 LB. OF KAURI COPAL HOW THE AMOUNTS OF RAW OIL AND BOILED OIL AND TURPS USED IN MAKING VARNISH THEREFROM MAY BE VARIED.

| Raw Oil. | Turps. | Boiled Oil. | Turps. |
|----------|--------|-------------|--------|
| lb.      | lb.    | lb.         | lb.    |
| 200      | 500    | 80          | 280    |
| 150      | 400    | 70          | 270    |
| 100      | 350    | 40          | 240    |

*N.B.*—With these recipes and all which precede and follow, whether given separately or in the text, any fraction or multiple of the above figure may be used, provided always that it is extended uniformly to each of the ingredients. Again, where only single lbs. are given, as in recipes 2 and 3, Table XXIV., the formula can be calculated out to cwts., etc., and so on, so as to work on practically tangible quantities.

TABLE XXII.—SHOWING FOR EVERY 200 LB. OF MANILLA AND BORNEO COPALS HOW THE AMOUNTS OF RAW AND BOILED OIL AND TURPS USED IN MAKING VARNISH THEREFROM MAY BE VARIED.

| No. | Raw Oil. | Turps. | No. | Boiled Oil. | Turps. |
|-----|----------|--------|-----|-------------|--------|
|     | lb.      | lb.    |     | lb.         | lb.    |
| 1   | 250      | 420    | 7   | 75          | 300    |
| 2   | 225      | 400    | 8   | 60          | 290    |
| 3   | 200      | 400    | 9   | 40          | 250    |
| 4   | 150      | 350    |     |             |        |
| 5   | 100      | 325    |     |             |        |
| 6   | 70       | 300    |     |             |        |

In Formula 1 hard Manilla alone is prescribed but is excluded in 2, whilst Borneo alone is used in 7. In the others either hard or soft Manilla or Borneo may be used.

TABLE XXIII.—SHOWING THE RELATIVE PROPORTIONS OF THE DIFFERENT INGREDIENTS IN KAURI VARNISHES.

| No.                  | 1      | 2      | 3      | 4      | 5      | 6      | 7      |
|----------------------|--------|--------|--------|--------|--------|--------|--------|
| Kauri . . . . .      | lb. 75 | lb. 94 | lb. 94 | lb. 84 | lb. 84 | lb. 84 | lb. 84 |
| Rosin . . . . .      | ...    | ...    | 14     | ...    | ...    | ...    | ...    |
| Boiled oil . . . . . | 98     | 179    | 100    | 94     | 20     | 84     | 84     |
| Turps . . . . .      | 112    | 131    | 117    | 113    | 120    | 126    | 122    |

| No.                  | 8      | 9      | 10     | 11     | 12     | 13     | 14     |
|----------------------|--------|--------|--------|--------|--------|--------|--------|
| Kauri . . . . .      | lb. 84 | lb. 70 | lb. 84 | lb. 84 | lb. 42 | lb. 28 | lb. 94 |
| Rosin . . . . .      | ...    | ...    | 14     | ...    | ...    | 42     | 56     |
| Boiled oil . . . . . | 94     | 18     | 20     | 148    | 86     | 86     | 144    |
| Turps . . . . .      | 109    | 112    | 120    | 140    | 112    | 104    | 140    |

1, hard church; 2, elastic carriage; 3, hard carriage; 4, best coating body; 5, quick oak; 6, pale French flatting; 7, flatting; 8, finishing body; 9, quick oak; 10, quick carriage; 11, common oak Kauri replaced by Manilla; 12, mixing; 13, mixing; 14, oak. The grade of Kauri and rosin vary with the qualities desired; mixed grades of Kauri are frequently used.

*Rebs' Stock Mixing Varnishes.*—Rebs uses Zanzibar copal for very hard varnishes, Accra, Benguela and Angola for medium hard and Sierra Leone (recent), Kauri and Manilla for ordinary hard varnish from which he makes six classes of stock varnish: No. 1 from Zanzibar or Madagascar; No. 2 from Accra, Benguela or Angola; No. 3 from Sierra Leone, Kauri or Manilla; No. 4 from débris of No. 2 resins; No. 5 from débris from No. 3; No. 6 from dust from resins Nos. 1 and 3. The different ingredients are prepared as follows. (1) *Linseed oil, "stand oil"*.—Raw oil is heated without driers until it deposits mucilage and clarifies, after which it is tanked for three to four weeks before use. (2) *Manganese boiled oil.*—

Linseed oil is slowly heated to 180° C. (356° F.), and at that temperature 2½ lb. of manganese borate is added for every 100 lb. of oil for a slow-drying oil, and 5 lb. for quick-drying oil, after which it is tanked for use. (3) *Litharge boiled oil*.—Linseed oil is slowly heated to 180° C. (356° F.), and at that temperature there is added, in small quantities at a time, 5 lb. of litharge. The litharge dissolves in the oil between 180° and 190° C. (356°-374° F.), and must be kept from settling at the bottom by constant stirring. The oil is finally heated to 220° C. (428° F.) and tanked for use.

TABLE XXIV.—SHOWING COMPOSITION OF STOCK COPAL VARNISHES (REBS).

| Stock Varnish No.                    | Grade of Copal (see above). |        |       |        |        |        |
|--------------------------------------|-----------------------------|--------|-------|--------|--------|--------|
|                                      | 1                           | 2      | 3     | 4      | 5      | 6      |
| Copal                                | lb. 1                       | lb. 1  | lb. 1 | lb. 10 | lb. 10 | lb. 10 |
| Linseed oil (see (1) above)          | 3 (oz). <sup>1</sup>        | 1      | ½     | ...    | ...    | ...    |
| Manganese boiled oil (see (2) above) | 3                           | 2      | 1     | 6      | ...    | ...    |
| Litharge boiled oil (see (3) above)  | ...                         | ...    | ...   | 5      | 6      | 6      |
| Spirits of turpentine                | 1 to 2                      | 1 to 2 | 1½    | 20     | 20     | 20     |
| Siccative.                           | ...                         | ...    | ...   | ½      | ½      | ...    |

These stock varnishes, the No. of which in above table corresponds with the grade of copal, are sold respectively as follows:—

(1) Extra superfine coach varnish, superfine coach varnish, superfine marble varnish, superfine artists' varnish; (2) superfine coach varnish, marble and artists' varnish, as substitute for No. 1, fine coach varnish, Nos. 1 and 2, fine carriage varnish, fine railway carriage varnish, superfine locomotive varnish, table-top varnish; (3) fine artists' varnish, varnish for carriage parts (frames and wheels), polishing varnish, enamel varnish, sledge varnish, finishing varnish, superfine copal varnish, gilt cabinet varnish, superfine sugar-mould varnish; (4) fine sledge varnish, finishing varnish No. 2, fine copal varnish for outdoor work, superfine copal varnish for indoor work, superfine floor varnish; (5) enamel, finishing, floor, furniture, etc., varnish; (6) varnish for sundry purposes as ordered.

*Copal Varnish for Fine Paintings*.—Fuse 8 lb. of the very cleanest pale African gum copal, and when completely run, pour in 2 gallons of hot oil (old measure), let it boil until it will string very strong, and in about fifteen minutes, or while it is yet very hot, pour in 3 gallons of turpentine (old measure) and got from the top of a cistern. Perhaps during the mixing a considerable quantity of the turpentine will escape, but the varnish will be so much the brighter, transparent and fluid, and will work freer, dry quickly and be very solid and durable when dry. After the varnish has been strained, if it is found too thick before it is quite cold, heat as much turpentine and mix with it as will bring it to a proper consistency.

<sup>1</sup> Ounces in this case only.

*Artists' Virgin Copal Varnish.*—From a parcel of scraped African gum copal, before it is broken, pick out the very fine transparent pieces which appear round and pale like drops of crystal; dry them in the sun or by a very gentle fire. Afterwards, when cool, bruise or pound them into a coarse powder; then procure some broken bottles or flint glass, and boil the same in soft water and soda, then bruise it into coarse powder like the gum; boil it a second time and strain the water from it, washing it with three or four waters that it may be perfectly clean and free from grease or any impurity, dry it before the fire, or upon a plate; set it in an oven. When it is thoroughly dry mix 2 lb. of it with 3 lb. of the powdered copal; after mixing them well put them into the gum pot and fuse the gum, keep stirring all the time; the glass will prevent the gum from adhering together, so that a very moderate fire will cause the gum to fuse. When it appears sufficiently run have ready 3 quarts of clarified oil very hot to pour in. Afterwards let it boil until it strings freely between the fingers, and mix it rather hotter than if it were body varnish, for as there is but a small quantity it will be sooner cold. Pour in 5 quarts of old turpentine, strain it immediately, and pour it into an open jar or large glass bottle, expose it to the air and light, but keep it both from the sun and wet and from moisture until it is of sufficient age for use. This is the finest copal varnish for fine paintings or pictures.

*Cabinet Varnish.*—Fuse 7 lb. of very fine African gum copal and pour in half a gallon of pale clarified oil; in three or four minutes after if it feel stringy take it out of doors or into another building where there is no fire and mix with 3 gallons of turpentine; afterwards strain it and put it aside for use. This, if properly boiled, will dry in ten minutes, but if too strongly boiled will not mix at all with the turpentine, and *sometimes* when boiled with the turpentine will mix, and yet refuse to amalgamate with any other varnish less boiled than itself, therefore it requires a nicety which is only to be learned from practice. This varnish is chiefly intended for the use of jappanners, cabinet painters, coach painters, etc.

*Best Body Copal Varnish for Coachmakers.*—This is intended for the body part of coaches and other similar vehicles intended for polishing. Fuse 8 lb. of fine African gum copal, add 2 gallons of clarified oil, old measure; boil it very slowly for four or five hours until quite stringy; mix off with 3½ gallons of turpentine; strain off and pour into a cistern. Observe, these varnishes, by being made in the gum pot and entirely without driers, are on that account much paler than when each run is poured into the boiling pot and afterwards boiled off. Varnish made entirely from African copal possesses more fluidity, pliability and softness than varnish made with or entirely from gum animé; it also possesses a property of keeping its colour or rather becoming bleached or paler after it is applied, whereas varnishes made from gum animé always become darker after being applied. Genuine copal varnishes from their pliability and softness are rather slow in drying and retain for months.

so much softness that they will not polish well until they give out a moisture and become hard, then they wear well, will never crack, and always retain their polish. As they are too slow in drying, coachmakers, painters and varnish-makers to remedy that defect have introduced to two pots of the preceding varnish one made as follows:—

|                              |                            |
|------------------------------|----------------------------|
| 8 lb. of fine pale gum animé | } to be boiled four hours. |
| 2 gallons of clarified oil   |                            |
| 3½ gallons of turpentine     |                            |

This after being strained is put hot into the two former pots and well mixed together; its effect is to cause the whole to dry quicker and firmer and enable it to take the polish much sooner.

Some varnish-makers, contrary to their own judgment, introduce into each small pot of varnish from half to one pound of either sugar of lead or white copperas, and sometimes only half of each; but no varnish made with driers will be so brilliant, colourless, pliable, or wear so long as that made without them. Every description of varnish which has lead for driers will always be the harder for them, and when worn for a time, if minutely looked into it will be found that the air has separated the particles of lead, which will be found upon the polished surface of the varnish like an almost imperceptible white dust exactly in proportion to the quantity of lead introduced into the varnish in making it.

*Common Body Varnish for the same Purpose as the First.—*

|                                 |                                       |
|---------------------------------|---------------------------------------|
| 8 lb. of the best African copal | } boiled four hours or until stringy. |
| 3 gallons of clarified oil      |                                       |
| 3½ gallons of turpentine        |                                       |

Mixed and strained will produce about 5½ gallons.

|                             |                    |
|-----------------------------|--------------------|
| 8 lb. of the best gum animé | } boiled as usual. |
| 2 gallons of clarified oil  |                    |
| 3½ gallons of turpentine    |                    |

Mixed and strained hot and put into the former pot of African gum-varnish. Put two pots of this animé varnish to one of copal. It will dry quicker and harder than the best body copal, and will polish very soon but not wear either so well or so long.

*Quick-drying Body Copal Varnishes for Coaches.—*

|                                    |  |
|------------------------------------|--|
| 8 lb. of the best African copal    | } boiled till stringy, mixed and strained. |
| 2 gallons of clarified oil         |  |
| ¼ lb. dried sugar of lead (p. 131) |  |
| 3½ gallons of turpentine           |  |

|                            |                     |
|----------------------------|---------------------|
| 8 lb. of gum animé         | } boiled as before. |
| 2 gallons of clarified oil |                     |
| ¼ lb. of white copperas    |                     |
| 3½ gallons of turpentine   |                     |

To be mixed and strained while hot into the other pot. These two pots mixed together will dry in six hours in winter and in four in summer; it is very useful for varnishing old work on dark colours.



*Best Pale Carriage Varnish.*—

8 lb. second sorted African copal }  
 2½ gallons of clarified oil } boiled till very stringy.

¼ lb. of dried copperas }  
 ¼ lb. of litharge } strained, etc.  
 5½ gallons of turpentine }

8 lb. of second sorted gum animé }  
 2½ gallons of clarified oil }  
 ¼ lb. dried sugar of lead } mix this to the first while hot.  
 ¼ lb. of litharge }  
 5½ gallons turpentine }

This varnish will dry hard if well boiled in four hours in summer and in six in winter. As its name denotes this is intended for the varnishing of the wheels, springs and carriage parts of coaches, chaises, etc., also it is that description of varnish which is generally sold to and used by house painters, decorators, etc., as from its drying quality and strong gloss it suits their general purposes well.

*Second Carriage Varnish.*—

8 lb. of second sorted gum animé  
 2½ gallons of fine clarified oil  
 5½ gallons of turpentine  
 ¼ lb. of litharge  
 ¼ lb. of dried sugar of lead  
 ¼ lb. of dried copperas (zinc sulphate, p. 131)

When three runs are poured into the boiling pot and the regular proportion of driers put in and well boiled, this varnish will dry hard and firm in four hours in winter and in two in summer; it is principally intended for varnishing dark carriage work or black japan and is also used by house painters for dark work.

*Wainscot Varnish.*—

8 lb. of second sorted gum animé }  
 3 gallons of clarified oil }  
 ¼ lb. of litharge } to be all well boiled until it strings very  
 ¼ lb. of dried copperas } strong and then mixed and strained.  
 ¼ lb. of dried sugar of lead }  
 5½ gallons of turpentine }

*N.B.*—Where large quantities are required it will always be found best to boil off the three runs in the boiling pot (pp. 115, 116). This varnish is principally intended for house painters, grainers, builders and japanners; it will dry in two hours in summer and four in winter.

*Mahogany Varnish* is either made with the same proportions with a little darker gum, otherwise it is wainscot varnish with a small proportion of gold size.

*Japanners' Gold Size.*—It is most proper to make gold size in iron pots, as from the great heat and the quantity of driers required copper pots are too thin and ductile; they would soon become quite burned at the bottom. Therefore, to make 40 gallons of gold size, put 10 gallons of oil into the set iron pot (Figs. 34, 35), make a good fire under it and boil it for two hours, then introduce 7 lb. of dry red lead, 7 lb. of litharge, and 3 lb. of copperas by sprinkling in a little at a time;

let the oil keep boiling all the time, not in too great a heat or it will perhaps run over. During the time of putting in the driers keep stirring them from the bottom of the pot, for should they settle in a mass before the oil has gradually taken them up it will darken the gold size, therefore keep constantly stirring and have the large iron ladle ready to cool it down if it should appear to rise too high; have also at hand an empty pot—the copper boiling pot will do—into which immediately ladle part of the boiling oil, if it cannot otherwise be kept in the pot, while the assistant is either choking or damping the fire with wet sifted ashes, of which there ought always to be a wheelbarrowful at hand in case of accident; but of which there need not be any fear if due precaution is observed. It is better to be a little under the heat than above it, particularly by those who are not experienced makers; it will only require a little longer boiling to make up for the deficiency of heat. When the oil has boiled about three hours from the beginning and the driers are all in fuse in the gum pot (Fig. 36) 10 lb. of gum animé, and during the time of fusing heat 2 gallons of raw linseed oil in the copper pouring jack by placing it on the plate of the gum furnace. After the oil has been poured to the gum and as soon as on examination it appears boiled clear, take the gum pot from the fire, let it cool for a few minutes, then pour it into the oil in the set pot. Wash out the gum pot and proceed with another run in the same way. When both runs of gum are in the set pot there are altogether 14 gallons of oil, 20 lb. of gum and 17 lb. of driers; increase and keep up a regular fire in the front of the furnace that it may be drawn out in a moment if it should be necessary. The gold size will soon throw up a frothy head on the surface, which must be kept down by constantly plying with the ladle, when it is likely to rise within 4 inches of the pot edge. In about five hours from the beginning of the oil boiling it will become stringy, but the boiling must continue until it hangs to the ladle, appears quite stringy, yet drops in lumps. When tried upon the glass if it feels sticky and strings strongly, then it is boiled enough. Draw out the fire, sprinkle it with plenty of water, leave not a spark of fire in the varnish house, not even a lighted pipe of tobacco. While the maker is cooling down the pot, let the assistant have ready at the door 30 gallons of turpentine, fill the pouring pot ready and have all the doors open. Endeavour to cool it as fast as possible, as it will require at least one hour and a quarter after the fire has been put out before it will be ready to mix, because the pot being iron and very thick and set in bricks, causes the gold size to hold heat a long time; therefore it is difficult to describe exactly at what time to mix the turpentine; for, if the oil and gum are not sufficiently boiled, the gold size will perhaps not dry quick; and if it should on the other hand be too strongly boiled before it is cold enough to mix, even though the fire be out, it may become what is termed coagulated or slimy, and is so much concentrated that its particles will not open with the turpentine and the whole becomes completely lost, so that it

is best to err on the safe side and stop the boiling in time. When the mixing commences, continue the pouring without intermission, until all the froth at the surface disappears, never stirring it until the turpentine is all in. If the pouring in of the turpentine is commenced while it was too hot, there will be a great loss of turpentine by evaporation, but that will not injure the quality of the gold size.

Place the carrying tin close to the side of the pot; lay on the tin ladle, and strain off as quickly as possible. When all the gold size is out pour into the set pot about 3 gallons of turpentine washings; with the swish, wash down the pot as quickly as possible, and, if the pot is still so hot as to evaporate the turpentine, ladle it out into the washings again and pour in about 3 gallons of raw linseed oil, and with a palette knife scrape it all round, washing and cleaning it down with a rag until it is quite cleansed all round, then ladle out the oil and wipe it completely clean and dry. The gold size ought to dry in from fifteen to twenty-five minutes and in fourteen days it is ready for use. Experienced makers can make gold size that will dry in fifteen minutes, but that requires great practice.

*Flock Gold Size.*—Put 12 gallons of linseed oil into the iron set pot; as soon as it has boiled for two hours introduce gradually 12 lb. of litharge. Continue the boiling very moderately for six hours; let it remain until next morning, then bring it to simmer and run 10 lb. of gum animé and 2 gallons of oil. When these two runs of gum are poured into the iron pot put in 7 lb. of Burgundy pitch, which soon melt, and continue the boiling and keep lading it down as before directed. For best gold size boil it moderately strong, but not over strong, and when proper mix it with 30 gallons of turpentine or more if required, but recollect this should be left a little thicker and stronger than japanners' gold size. This is intended for and used by paper stainers to lay their flock on and ought to dry slowly in one hour.

*Axioms Observed in the Making of Copal Varnish.*—The more thoroughly the gum is run or fused the greater the quantity and the stronger the produce. The more regular and longer the boiling of the oil and the gum together is continued the more fluid or free the varnish will extend on whatever it is applied. When the mixture of oil and gum is too suddenly brought to string by too strong a heat the varnish requires more than its just proportion of turpentine to thin it, whereby its oily and gummy quality is reduced, which renders it less durable, neither will it flow so well in laying on. The greater the proportion of oil there is used in varnishes the less they are liable to crack, because the tougher and softer they are. Increase the proportion of gum in varnishes the thicker the stratum and the firmer they will set solid and dry quick. When varnishes are quite newly made and must be sent out for use before they are of sufficient age, they must always be left thicker than if they were to be kept the proper age as some of the annexed experiments by

Wilson Neil, the account of which is given in his own words, will prove:—

*Experiment I.*—Of two well-got-up panels painted with patent yellow I varnished the first with good body varnish twelve months old; the second panel was varnished with body of the like quality only one month old. After both panels were dry on examining the first it was excellent, but that varnished with the new-made looked poor, flat and sleepy as it is termed.

*Experiment II.*—Of two panels both prepared and flatted down the first I varnished with gold size and the second with japan; both had only been made one month. The gold size dried in half an hour and the japan in ten hours and twenty minutes. I then put both panels into an empty drawer where they remained for eight months. I then tried the same gold size and japan on two fresh panels prepared exactly as the first, when I found the gold size much thicker yet much paler, and it now dried in fourteen minutes, the japan also dried in seven hours.

*Experiment III.*—That varnish made from African copal alone possesses the most elasticity and transparency may be proved by the following facts. Three prepared panels of a very pale straw colour were all varnished in one day; the first with fine body varnish made from very pale gum animé, the second with fine body varnish made from one half animé and one half African copal. These three varnishes were all made with the greatest nicety for the experiment, all equal in their proportion and ages, having been all made in one day. At the time of varnishing the three panels the varnishes were all eight months old. I filled three vials, one with each sort, and could discover no difference in the colour either when held near to the eye or at a distance. Upon moving the vials and turning them, the third, containing the African copal, appeared the most elastic. All the three panels dried in about the same time—eight hours. I hung them all three where they were exposed to the sun, wind and rain for one month. I then examined them and could perceive little if any difference in colour. I left them for another month, when, on examination, the first, made from animé, was darkest and that from the copal the palest. I then polished all three; the first polished very easily, the second not quite so easily, and the third was very difficult to polish, appeared very soft and clammy, but when completed was by far the palest and most transparent. I left them upon a roof exposed to the weather for three months, when I flattened them down a little and varnished them afresh. In ten days I polished them, when the third, varnished with the African copal, was by far the palest and looked like plate-glass.

*Experiment IV.*—That too much Driers in Varnish render it Opaque and unfit for Delicate Colours.—One day I varnished two panels got up and glazed with a very rich crimson lake. No. 1 was varnished with body varnish made entirely from African copal without any driers whatever either in the clarified oil or boiling; No. 2

was varnished with "body" of the same gum, age and proportion, but with a small quantity of dried sugar of lead and dried white copperas. The panel No. 1 dried in nine hours and remained tacky for five hours more; the panel No. 2 dried in seven hours without a tack. In a day after both panels were flatted down and varnished and repeated until each panel had four coats of varnish. The varnish was eight months old and each dried in the same space of time. I hung both up for a month and then polished them and examined them with a microscope, when the panel No. 1 appeared quite clear in colour, solid and brilliant like plate-glass, but No. 2 had changed a little in colour, inclining to purple, and in the varnish were almost imperceptible opaque points. I kept these two panels for two years afterwards; when I examined them, there appeared no decay in No. 1, but in No. 2 the driers were perceptible on the surface with the naked eye.

*Experiment V.*—That moist driers boiled in varnish cause it to run in pinholes. To 8 gallons of very fine African copal during the boiling I introduced  $\frac{1}{2}$  lb. of undried sugar of lead. After the varnish had stood to settle for eight months, I varnished with it a pale patent yellow panel; it floated very well, set and looked well for hours when it began to dry off in small pinholes completely over the surface, some of the holes as large as the head of a pin. It dried off in seven hours without any tack.

*Experiment VI.*—That the greater the quantity of driers and acid the larger the pinholes. I emptied 6 gallons out of the jar containing the last-named varnish, then I varnished another panel out of the 2 gallons remaining in the jar; the panels dried in the same time, but went off not only into pinholes but large blotches all over.

*Experiment VII.*—That particles either of oil or cold turpentine in the varnish will create pinholes and blemishes. To 1 gallon of body varnish nine months old, which had been tried and found to be excellent, I introduced  $\frac{1}{4}$  ounce of water and  $\frac{1}{4}$  ounce of linseed oil. I heated and mixed all together and poured it into a jar and let it stand for three months, when I varnished two panels, one yellow, the other light green. Four hours after, when I examined them, they were about half dry and beginning to run into pinholes and round empty holes. I examined them with a microscope and found a particle of oil hanging to the lower edge of every circle and the small particles of water had evaporated; the surface appeared as if dotted with the points of so many bristles. I repeated this experiment several times, but always with the same result.

*Experiment VIII.*—That copperas does not combine with varnish, but only hardens it. Three pounds very fine African copal, 1 gallon of clarified oil and 2 ounces of dried copperas were mixed off with 2 gallons of turpentine, which, after being strained, had been put by in an open-mouthed jar for eight months. I then poured off all the varnish not quite to the bottom; I afterwards well washed the sediment left at the bottom of the jar with 2 quarts of warm turpentine,

which I filtered through some very fine cambric muslin and afterwards dried the copperas in the sun ; it still weighed 2 ounces and appeared like what it really was, powder of zinc.

*Experiment IX.*—That sugar of lead does combine with varnish. With the same quality and quantity of gum and oil and turpentine I made 3 gallons of copal varnish, introducing 2 ounces of dried sugar of lead during the boiling. I put it in a jar for eight months ; I then poured off all the varnish and washed out the sediment with half a gallon of turpentine filtered as before. I dried the residuum left on the muslin, which only weighed 7 drams, so that the varnish had absorbed the remainder. This varnish was very good and dried well.

*Experiment X.*—That turpentine improves by age. Three pounds of fine African gum copal were boiled without driers and thinned with 2 gallons of turpentine which had been kept in the open lead cistern for upwards of two years until it had become thickened and appeared like oil. After being mixed off and strained and set to settle only two days I tried it on several panels of different colours, when it dried hard, firm and brilliant without any tack in less than eight hours. I kept the remainder of the varnish for twelve months, when it became too thick to use. I poured it into the gum pot, brought it near to a boiling heat and poured into it half a gallon of the same old turpentine and set it aside for two days, when I varnished three fresh panels of three different colours which had been previously twice varnished ; they all dried firm and free from tack in less than five hours. These three panels were afterwards laid on the roof of a shed for twelve months and when polished looked solid and brilliant and the colours were less changed than any I ever saw in the time.

#### CAOUTCHOUC OIL VARNISHES.

These are employed especially to render articles waterproof. But in dissolving the rubber it is reduced to a tacky substance. The rôle of rubber is not in varnish-making and it is used with quite a mistaken idea. In many so-called india-rubber varnishes the rubber is conspicuous by its absence. The instructions for making india-rubber varnish are that the rubber should be dry, so that solution may be effected under good conditions. The rubber is cut into thin strips and placed in a stove, where it is kept at 40° to 50° C. for several days. Moreover, the operation is generally started by "swelling" the rubber with one-half part of ether.

The proportions used are : Caoutchouc, 1 lb. ; linseed oil, 1 lb. ; spirits of turpentine, 1 lb.

The rubber, left in contact with ether for several days, swells and gives a fluid mass when heated on the water bath so as to drive off the ether ; this fluid mass whilst still hot is mixed with linseed oil and finally with spirits of turpentine.

*Hancock* dissolved the rubber in a cylindrical iron vessel capable

of standing pressure, the lid being fixed by bolts and nuts. The vapour of the solvent passes into this vessel through a pipe leading from the still in which it is generated.

*Mixed Varnishes.*—Oil varnish may also be added to rubber so as to impart both durability and hardness. In these cases, the proportions of oil and spirits of turpentine are increased, thus to 12 lb. of copal varnish there is added a caoutchouc varnish consisting of: Caoutchouc, 1 lb.; linseed oil, 6 lb.; spirits of turpentine, 4 lb. *Miller's India-Rubber Varnish.*—Caoutchouc, 5 lb.; carbon disulphide, 2½ lb.; spirits of turpentine, 5 lb. The rubber is cut into very small pieces and digested with the carbon disulphide in a glass retort heated in a sand bath until complete solution is effected. The linseed oil is then heated, and whilst still hot added to the above solution which after cooling is thinned down with the spirits of turpentine. *Winkler's Rubber Varnish.*—Caoutchouc, 6 lb.; rectified spirits of turpentine, 12½ lb.; rectified shale naphtha, 15 lb. The rubber is dissolved in the mixed solvents in a retort heated on a sand bath, and the recently warmed copal varnish is then added. *Champagne's Rubber Varnish.*—Caoutchouc, 6 lb.; spirits of turpentine, 50 lb. The rubber is digested with a portion of the spirits of turpentine for two days without stirring, after which it is well stirred with a wooden spatula. When all the turpentine has been taken up the remainder is added. The digestion and stirring are continued until the whole is dissolved. Then a varnish is made as follows: Above solution, 75 lb.; pale boiled oil, 75 lb.; finest pale copal varnish, 100 lb. These are well mixed and incorporated together by agitation and then digested on the sand bath until complete amalgamation and solution is effected. Caoutchouc oil varnishes, with a certain brilliancy and harder, are made by adding rosin, say: Caoutchouc, 1 lb.; rosin, 2 lb.; linseed oil, 2 lb.

*Dammar Oil Varnish.*—Dammar or soft copal (copal tendre) varnishes are soft, very flexible and transparent, but dry rather slowly. They are employed for inside work or upon metals, or on tissue paper, which they render transparent. These varnishes have a bright appearance, and a faint pale yellow coloration. The colour may be varied from golden yellow to yellowish brown by gamboge, dragon's blood and asphaltum of Judæa, and coloured in this way they enter into the composition of certain English varnishes used for metallie boxes and cases.

The proportion of the different elements vary between:—

|                                 | Parts.     |
|---------------------------------|------------|
| Dammar . . . . .                | 100        |
| Boiled linseed oil . . . . .    | 50 to 120  |
| Spirits of turpentine . . . . . | 200 to 500 |

The dammar is pulverised and dissolved in the hot in spirits of turpentine, and boiled linseed oil or linseed oil to which a liquid drier has been added is run into the solution.

If the harder kinds of dammar be used, they may be rendered

more soluble in linseed oil by the addition of a small quantity of very soft dammar.

*Rosinate Oil Varnishes.*—Rosinates may be substituted for resins in varnish-making. Coloured rosinates are generally used. Some—like rosinate of copper, which is of a beautiful emerald-green tint—are coloured naturally. The desired shade is imparted to colourless resins by aniline dyes. Coloured rosinates in the dry state have a fresh appearance, and those used in varnish-making are insoluble in water; weak acids and alkalies have no action on these resins, but on the other hand they dissolve very easily in alcohol, spirits of turpentine, benzol, ether and chloroform as well as in melted wax, resins, oils and boiled linseed oil. This facility of solution and their beautiful colour cause them to be greatly used, and they have been advantageously applied upon metal, wood, paper, skin, glass, wax, linoleum and cloth.

*Preparation of Rosinates.*—A rosin soap is made by heating 100 parts of pale rosin with 33 parts of soda crystals in 1,000 parts of water, and adding to the solution cooled to 50° a solution of colouring matter; a solution of a metallic salt is then added such as the chloride of magnesia, and the solution is filtered from the insoluble coloured rosin which is well washed and dried at a very gentle heat. The dried product constitutes in reality a true coloured lake.

For toys, tin boxes, etc., cheap and quick-drying varnishes are required, and in the preparation of these the resins and even common rosin have been replaced by rosinates which dissolve readily in warm linseed oil, and some of these, more especially the rosinate of zinc in particular, is very durable. These rosinate varnishes are made by dissolving the rosinate in linseed oil heated to about 120° C. and then diluting with the necessary quantity of spirits of turpentine. The rosinates most usually employed are those of lead, zinc, manganese and lime. A great number of aniline dyes being soluble in solutions of certain rosinates, coloured rosinate varnishes may be made of any desired hue. Fused rosinates are made by heating rosin with metallic oxides (*e.g.*, what is called *hardened rosin* is made by heating rosin with quick-lime; the product will dry better if a little manganese be stirred in at the same time).

*Antifouling Composition.*—A quick-drying varnish suitable for antifouling compositions may be made by dissolving rosin in half its weight of shale naphtha. To this is added an equal bulk of japanners' gold size, in which spirits of turpentine has been replaced by shale naphtha. Finally, to the above mixture, an equal bulk of a solution of rosinate of lime or rosinate of copper or an admixture of both dissolved in their own weight of shale naphtha is added, and finally the requisite amount of colour along with the toxic principles if any, say a mixture of emerald (Paris) green and salicylic acid.

*Polychrome Varnishes.*—Very often different colours are imparted to varnishes for metals, particularly tin, by aniline dyes. But these



having a very feeble resistance, they are advantageously replaced by metallic compounds, principally green copper-salts. According to Lohmann, 30 parts of finely pulverised acetate of copper are heated on the water bath until a bright, brown powder remains; this powder is mixed with double its weight of spirits of turpentine and heated to 75° C. There is then added 100 parts of good copal varnish. If the acetate of copper has been pulverised finely enough, it rapidly and almost completely dissolves. After standing, a deep green varnish is obtained. To impart to tinned objects a beautiful green colour four or five coats of this varnish are laid on. If only two coats be applied, and if the articles be placed in a store, there is obtained, according to the temperature, different shades of colour varying from golden yellow to deep yellow, and from greenish yellow to orange yellow. The same golden colour may be obtained upon glass.

## CHAPTER VIII.

### ROSIN OIL VARNISHES—BRUNSWICK BLACK—SUPER-BLACK JAPAN.

*Rosin Oil Varnishes.*—Owing to its cheapness (although its price has been rising rapidly of late), and also on account of the readiness with which it may be dissolved, rosin enters into the composition of many varnishes. In the various formulæ already given in actual practice rosin can often replace a certain portion of the gum resins. Rosin dissolved in coal tar, petroleum or shale naphtha, or in white spirit, gives by itself alone a glossy quick drying varnish of much better quality than the uninitiated would suppose possible. The varnish got by solution of rosin in turps is much more tacky. The boiled oil to be used in rosin varnishes cannot be boiled too much nor too hard. Very fine pale varnishes may be made by using rosin only, provided choice qualities are used, as pale as can be procured, and dissolving it in the cold. It is then advantageous to use linseed oil which has been boiled for a sufficiently long time without the addition of driers. The proportions generally used are: Rosin, 100 lb.; linseed oil, 25 to 30 lb.; spirits of turpentine, 125 to 180 lb. A certain portion of the spirits of turpentine or the whole of it is sometimes replaced by naphtha. For certain small articles, such as boxes for confectionery, snuff-boxes, etc., a simple solution of rosin in linseed oil is used; several successive coats are applied, the article being "stoved" after each coat. The proportions are: Rosin, 1 lb.; boiled oil, 1 gallon. Plaster casts are hardened and rendered unalterable by atmospheric agents by this last composition. The casts are well dried and heated to 80° to 90° C. (176° to 194° F.), are dipped into this solution, dried in the air, again dipped, and finally dried completely in the air. *Mixed Varnish.*—A little more elasticity is supposed to be imparted to rosin varnishes by replacing a part of the rosin by Venice turpentine or mastic, and by increasing a little the quantity of oil, the proportions in such cases being as follows:  $\frac{5}{8}$  rosin +  $\frac{1}{8}$  Venice turpentine, 100 lb.; linseed oil, 60 lb.; spirits of turpentine, 120 lb.

But if Venice turpentine be a good addition to brittle spirit varnishes it should be kept out of varnishes into which linseed oil, spirits of turpentine and rosin enter. Such a varnish is quite tacky enough as it stands without Venice turpentine to make it more so.

TABLE SHOWING COMPOSITION OF VARIOUS OIL-VARNISHES MADE FROM ROSIN.<sup>1</sup>

|   | 1   | 2   | 3   | 4   | 5   | 6   |
|---|-----|-----|-----|-----|-----|-----|
|   | lb. | lb. | lb. | lb. | lb. | lb. |
| Rosin . . . . .                                   | 220 | 220 | 260 | 220 | 100 | ... |
| Boiled oil . . . . .                              | 70  | 60  | 30  | 70  | 50  | ... |
| Shellac . . . . .                                 | ... | 10  | 5   | ... | ... | ... |
| Manganese oxide . . . . .                         | ... | 10  | 20  | ... | ... | ... |
| Dammar . . . . .                                  | ... | ... | ... | ... | 100 | ... |
| Spirits of turpentine or "white spirit" . . . . . | 140 | 140 | 180 | 200 | 180 | ... |

In 2 and 3 the black oxide of manganese is ground and made into a paste with the litharge boiled oil, which is gradually added to the fused mixture of shellac and rosin, and the whole boiled for one and a half hours at a temperature of 190° C., after which it is cooled and thinned with the spirits of turpentine or by benzene. In 1, 4 and 5 the rosin is first melted and then the quick-drying litharge boiled oil added, and the whole "boiled" for an hour at 190° C., when the mass is cooled and thinned down with the spirits of turpentine which may be replaced by shale or petroleum naphtha, "white spirit," etc.

*Copal Varnish Substitute.*—One hundred and twenty-five pounds of "good strained" rosin are heated to 180° to 190° C. and 5 parts of either litharge or manganese borate added thereto, and the whole heated until the temperature rises to about 230° C. and a drop hardens on a glass slab so much that it can scarcely be removed therefrom. There is then introduced into it 20 parts of either litharge or manganese boiled oil containing 5 per cent. of either drier, and the heat continued for another hour, after which it is taken from the fire and thinned down with 100 parts of spirits of turpentine and filtered, and then ½ to 1 per cent. of copal oil added. This varnish dries quickly, yielding a very hard, smooth, highly polished coat.

*Wallpaper Varnish.*—Eight gallons of linseed oil are heated to 170° C. (338° F.) until it ceases to froth; there are then added 32 lb. rosin, 16 lb. paraffin wax, 4 lb. of beeswax and 1 pint of copal varnish.

*Brewers' Pitch.*—Much rosin is used for the preparation of this substance. It is used in breweries to produce a smooth lining inside casks whereby they are made much easier to clean. Brewers' pitch consists of rosin mixed with substances which have no effect upon the taste and aroma of the beer. The simplest way of making a good brewers' pitch is to fuse pure American rosin with careful stirring to prevent the rosin from burning to the bottom of the pan.

<sup>1</sup> The rosin may be replaced by rosinate, say rosinate of lime, and in that case the turps may well be replaced by coal tar naphtha. But that may of course be done in any case or even by white spirit. Some low grade compositions are made by dissolving rosin in crude burning oil (petroleum).

During the stirring sufficient rectified oil of turpentine is added gradually to make the mass free from brittleness when cold. In using the pitch a new cask is heated with a blast of hot air, and when thoroughly heated a proper quantity of melted pitch is poured in and spread over the sides of the cask by rolling the cask about until it is quite cold. To repitch a cask, set fire to the old pitch, let it burn some time, extinguishing it by putting the head on the cask, and repitch as a new cask. Many makers of brewers' pitch use a certain amount of rosin oil instead of rectified oil of turpentine to make the mass supple. The rosin oil used must be rectified, as the crude oil would impart its penetrating smell to the beer. Others give the necessary suppleness to the rosin by fusing it with a soap made by boiling part of the rosin with caustic soda lye. Some recipes for making brewers' pitch advise the addition of lampblack or ochre, or of beeswax. All such additions are not only absolutely superfluous, but are very injurious to the beer kept in the casks. This is especially true of lampblack which contains not only carbon but very considerable quantities of empyreumatic bodies of characteristic taste and smell, eminently calculated to spoil the flavour of beer.

*Varnishing and Paraffining Casks.*—The varnishing of new casks gives but little trouble. It is, however, quite a different matter with casks which have been for a long time in use, and have the inside of the wood covered with hard thick coats of rough shellac. In this case complete removal of the old varnish is an indispensable preliminary. The cheapest and simplest method is with boiling caustic lye, but as in many places this cannot be done, it is usual to heat the inside of the casks and then to scrape and sandpaper the wood as clean as possible. But there is always some of the old varnish left, and when new coats have been applied and the cask has been filled, blisters form over the old varnish. A better plan is to make a paste of strong caustic soda lye and quicklime, and to paint the inside of the casks with it over-night. On the following morning the shellac can be washed away with warm water from a hose. A second application of the caustic is very rarely necessary. Pitch can also be removed from casks in this way, but the application of the paste must be repeated several times. When cleaned and rinsed the casks are dried and warmed, smoothed inside with sandpaper, and varnished while still warm. Several days should elapse between the drying of the varnish and the putting beer into the cask, and it is preferable to give it a few good rinsings first. If the directions have been observed, and the varnishing has been properly done in a uniform manner with good and not too thick varnish, the inside of the cask will keep its lustrous surface for years.

In paraffining a cask, the wood must be hotter than for varnishing, and the paraffin, heated to about 190° F., must be applied with a brush in successive coats until the wood is saturated. This generally requires three to four applications. When the cask is cold the

superfluous paraffin is scraped off and the cask is thoroughly rinsed with water first warm and then cold. Paraffining is cheaper than varnishing, and paraffined casks are more easily cleaned and more durable than varnished ones.

*Asphaltum Varnishes.*—Two kinds of asphaltum come upon the market for varnish-makers, namely, Syrian and American asphaltum. The former is readily soluble, gives a good lustre, and serves for making fine black varnishes which are specially remarkable for their hardness and for the force with which they adhere. Consequently, Syrian asphaltum commands a high price. American asphaltum is a raw material for ordinary asphaltum varnishes, especially for those intended for iron work of all kinds. They are inferior in appearance to the varnishes made from Syrian asphaltum. All asphaltum varnishes are made either in the cold by shaking up the broken asphaltum with the solvent in specially constructed plant, or what is sometimes better, the same procedure is followed as with copal; that is to say, the asphaltum is first melted by itself by the application of heat, and then gradually treated in the fused state with the solvent, proper precautions against the danger of fire being, of course, observed. It is best, of course, to heat the melting-pot with steam, but if a naked fire is used it must be carefully extinguished before the solvent is poured on to the hot asphaltum. After the asphaltum is dissolved, by either process, the mass is allowed to stand for insoluble matters to sink to the bottom. The varnish is then drawn off, and is at once ready for use. Substitution of rosin for part of the asphaltum naturally makes the varnish cheaper, and is therefore not unfrequently practised.

Asphaltum varnish made with turpentine dries quickly and has scarcely any smell, while the varnish made with benzole always possesses a disagreeable odour. This can, however, be avoided by using as pure a benzole as possible—that is, one with as little colour and as high a boiling-point as possible. Although such benzoles are dearer than the impure kinds, they make a more rapidly drying varnish, and also dissolve the asphaltum much more quickly. Asphaltum varnishes made by dissolving the resin in heavy coal-tar oils are the worst, as they always dry very slowly, and have a very unpleasant odour.

Besides natural asphaltum, use is made of an artificial substance made by blowing air through heated petroleum residues. This expels some of the constituents and leaves behind an asphaltum-like mass which is used for varnish-making. The varnishes made from it are distinctly harder, duller and less valuable than the natural asphaltum varnishes; but their cheapness makes them much used for the principal use of the inferior natural varnishes, namely, for the painting of ironwork. The recipes for making the various kinds of asphaltum varnish are very numerous. For the sake of completeness we will quote some of the best. For the better qualities of asphaltum varnish melt 100 lb. of asphaltum, and stir into the warm

mass 75 lb. of turpentine and 17 lb. of boiled linseed oil. This makes a specially good varnish for wood. A good varnish for iron is prepared by fusing together 100 lb. of asphaltum and 25 lb. of rosin, and then stirring gradually in 500 lb. of boiled linseed oil. Finally, the varnish is mixed with 50 lb. of amber previously dissolved in 20 lb. of drying oil, and thinned with 250 lb. of turpentine and filtered through cotton. Fine qualities of elastic asphaltum varnish are obtained by adding solution of india-rubber. A mixture is made of 100 lb. of copal and 50 lb. of boiled linseed oil, with a solution of 6 lb. of india-rubber in 200 lb. of turpentine or petroleum spirit. A mass consisting of 100 lb. of asphaltum, and from 150 to 200 lb. of boiled oil mixed separately is then added, and the varnish is finally thinned with from 400 to 500 lb. of turpentine. This varnish consequently contains from '6 to '65 per cent. of india-rubber.

The better varieties of asphaltum varnish are applied with a brush to a previously warmed surface, or the article may be warmed after the varnishing. The object of warming is to accelerate the drying, which would otherwise be rather slow. Ironwork is painted in the ordinary way with the asphaltum varnish, and allowed to dry at leisure.

It is advisable, according to Livache, to boil the asphaltum for a sufficiently long time, sometimes for several days, to drive off the volatile products, which might render it dull, but unless the asphaltum contains paraffin this is not necessary.

#### BLACK VARNISH FOR IRON WORK.

|                                 | I.                 | III.          |
|---------------------------------|--------------------|---------------|
|                                 | lb.                | lb.           |
| Fused amber, No. 5 . . . . .    | 12                 | ...           |
| Syrian asphaltum . . . . .      | 12                 | 8             |
| Double boiled oil . . . . .     | 10                 | 6             |
| Litharge . . . . .              | 1                  | $\frac{3}{4}$ |
| Spirits of turpentine . . . . . | 48                 | 22            |
| American rosin . . . . .        | ...                | 4             |
|                                 |                    | III.          |
|                                 |                    | lb.           |
| Fuse { Copal . . . . .          |                    | 12            |
| Rosin . . . . .                 |                    | 30            |
| Asphaltum . . . . .             |                    | 30            |
| Yellow Wax . . . . .            |                    | 5             |
| Venice turpentine . . . . .     |                    | 6             |
|                                 | add                |               |
| Rosin oil . . . . .             |                    | 12            |
| Boiled oil . . . . .            |                    | 30            |
|                                 | and thin down with |               |
| Spirits of turpentine . . . . . |                    | 30            |
| Naphtha . . . . .               |                    | 30-45         |

ASPHALTUM VARNISH FOR LOCKS.

|                                 | A.  | B.       |
|---------------------------------|-----|----------|
|                                 | lb. | lb.      |
| Asphaltum . . . . .             | 1   | 100      |
| Boiled linseed oil . . . . .    | 25  | 5 to 16  |
| Spirits of turpentine . . . . . | 50  | 50 to 60 |

But as A varnishes dry slowly it is preferred to make them from the proportions given in B.

BLACK JAPAN.

|                                 | lb. |
|---------------------------------|-----|
| Raw linseed oil . . . . .       | 25  |
| Prussian blue . . . . .         | 3   |
| Litharge . . . . .              | 1½  |
| Fused amber, No. 5 . . . . .    | 18  |
| Syrian asphaltum . . . . .      | 18  |
| Spirits of turpentine . . . . . | 90  |

The raw linseed oil, Prussian blue and litharge are heated together in an enamelled iron vessel and boiled with constant stirring until the mass assumes a syrupy consistency. The pan is removed from the fire as soon as the contents begin to froth and replaced as soon as they subside. After boiling for ten to twelve hours the whole is cooled over-night so that the litharge may settle out. The bluish-black mass is now transferred to a large enamelled pan and the fused amber and asphaltum added. The pan is placed on the fire and the contents heated until the amber and asphaltum are completely dissolved, after which it is allowed to cool and then thinned down with 90 lb. of spirits of turpentine and filtered through calico.

Cycles and sewing machines afford by far the largest employment for enamel varnishes. The object of them is to give iron a hard and yet elastic coating of a lustrous black colour. The iron must be absolutely dry when the enamel is applied. The following recipe can be recommended in every way:—

Fuse 50 lb. Angola copal, add to it 41 lb. of boiled linseed oil (boiled with sugar of lead and sulphate of zinc). Pour the mixture into 200 lb. of fused American asphaltum, and boil till the mass draws out into threads. Then add 100 lb. of a liquid drier and 336 lb. of oil of turpentine.

By the name of *Brunswick Black* we formerly understood varnishes made of Syrian or Trinidad asphaltum, and only exceptionally those which required to be dried in a stove. A special kind made in England, called *japan black*, is used for carriage work. The coats are covered when dry with copal, and then show no green colour. The cheaper sorts of *Brunswick black* are made from various artificial pitches or residues of the dry distillation of coal-tar, petroleum, etc. The tests of a good asphaltum are solubility in oil of turpentine, insolubility in alcohol, and the colour and good drying of the *Brunswick black*. The amount of matter insoluble in oil of turpentine may be as much as 50 per cent. in an inferior asphaltum, and except for special purposes, *i.e.*, the preparation of a dull drying varnish,

such asphaltums are unfit for use, as, except as above stated, the insoluble matter must be rejected, and the loss of it and the waste of solvent fully compensate for the lower price. Of late, Brunswick black varnishes have been required for the sewing machine, the bicycle and other trades, which form a very hard and strongly adhering coat, which will even stand blows with a hammer. In this case the coats are dried in the stove at from 120° to 180° C. and even more, and it has been found that the first-rate natural asphaltums may for this purpose be mixed with artificial products, such as stearine pitch, petroleum pitch and bone pitch. Some of these make the varnish dry very badly at ordinary temperatures, but in the stove it gives the result desired.

*Black Japan* (the best) is made after the manner of gold size. Put 6 gallons of raw linseed oil into the set-pot, boil it with a very slow fire. Have a 10-gallon cast-iron pot with two handles or ears, into which put 10 lb. of Egyptian asphaltum and make a good fire in the furnace—it will require a good regular fire all the time of fusion. There ought to be an iron cover exactly to fit the fusing-pot, and also a pair of pot-hooks for lifting it from the fire, for sometimes if the pot is thin and the fire too brisk it requires lifting from the fire a few minutes to moderate the heat. During the time the asphaltum is fusing have 2 gallons of oil getting hot to mix with it as soon as it is sufficiently melted. After it is oiled, leave it on the fire about ten minutes, then either lift it by the pot-hooks and pour it into the set-pot or otherwise empty it with a ladle; whichever way it is emptied, leave the stones, etc., at the bottom. Carry it out of doors and with a handful of hay or straw clear it out, and afterwards wash it out with turpentine washings and dry it with a rag. Proceed and finish three more separate runs like the first until there are four runs in the set-pot, that is 40 lb. of asphaltum and 14 gallons of linseed oil, then introduce exactly the same driers as for the gold size, and in the same manner. Keep a regular but moderate fire so that the boiling continues at a moderate heat for four hours from the last run being poured into the set-pot, then draw and put out the fire for that day. Next morning, as soon as it can be brought to a boil, try it upon a bit of glass; if it but strings strongly it will not do; it must be boiled so strong that when a piece is pinched from off the glass after it has been left to cool, it will roll into a hard pill between the finger and thumb. When it forms hard and scarcely sticks to the fingers, it is then boiled enough. Put out the fire as directed before. Leave it one hour and a half before mixing; when cold enough mix it with 30 gallons at least of turpentine and strain it. If it is too thick when cold heat and introduce as much turpentine as will bring it to a proper consistency. The japan will dry in six hours in summer. It is principally intended for and used by coachmakers, japanners, painters, etc., and should be kept at least six months before it is used.

*Another Black Japan* is made by putting into the set-pot 48 lb.



of Naples asphaltum or any other foreign kind, except Egyptian. As soon as it is melted pour in 10 gallons of raw linseed oil. Keep a moderate fire and fuse 8 lb. of dark gum animé in the gum-pot, mix it with 2 gallons of hot oil and pour it into the set-pot. Afterwards fuse 10 lb. of dark or sea-amber in the 10-gallon iron pot; keep stirring it while fusing, and whenever it appears to be over-heated and rising too high in the pot lift it from the fire for a few minutes. When it appears completely fused pour in 2 gallons of hot oil, and pour it into the set-pot; continue the boiling for three hours longer, and during that time introduce the same quantity of driers as before directed; draw out the fire and let it remain until morning, then boil it until it rolls hard as before directed; leave it to cool and afterwards mix with turpentine. This japan will appear in colour like the other, but when applied on work it will dry more hard, compact and glossy, and will not rub down or polish so soon as the other, which is occasioned by the toughness and durability of the amber.

*Best Brunswick Black.*—In an iron pot over a slow fire boil 45 lb. of foreign asphaltum for at least six hours, and during the same time boil in another pot 6 gallons of oil which has been previously boiled. During the boiling of the 6 gallons introduce 6 lb. of litharge gradually and boil it until it feels stringy between the fingers, then ladle or pour it into the pot containing the boiling asphaltum. Let the mixture boil until upon trial it will roll into hard pills, then let it cool and mix it with 25 gallons of turpentine or until it is of a proper consistency.

*Ironwork Black.*—Put 48 lb. of foreign asphaltum into an iron pot and boil for four hours. During the first two hours introduce 7 lb. of red lead and 7 lb. of litharge, 3 lb. of dried copperas and 10 gallons of boiled oil; add one 8 lb. run of dark gum with 2 gallons of hot oil. After pouring the oil and gum continue the boiling two hours, or until it will roll into hard pills like japan. When cool thin it off with 30 gallons of turpentine or until it is of a proper consistency. This varnish is intended for blacking the ironwork of coaches and other carriages.

*A Cheap Brunswick Black.*—Put 28 lb. of common black pitch and 28 lb. of common asphaltum made from gas-tar into an iron pot; boil both for eight or ten hours which will evaporate the gas and moisture. Let it stand all night, and early next morning, as soon as it boils, put in 8 gallons of boiled oil, then introduce gradually 10 lb. of red lead and 10 lb. of litharge and boil for three hours, or until it will roll very hard. When ready for mixing introduce 20 gallons of turpentine or more until of a proper consistence. This is intended for engineers, founders, ironmongers, etc.; it will dry in half an hour or less if properly boiled.

*Another Cheap Brunswick Black.*—Put 28 lb. of common pitch and 28 lb. of gas asphaltum into an iron pot; boil these for eight or nine hours. Leave it until next morning, then bring it to a simmer, and gradually introduce 7 lb. of red lead and 7 lb. of litharge, and

continue it at a low heat while the oil is got ready. Put 5 gallons of boiled oil into the set iron pot, and boil it until it will blaze inside the pot when a lighted taper is held over it. As soon as it will catch fire carry it out into the yard, put a ladle into the burning oil and move it gently from the bottom. In about ten minutes from its catching fire have the iron cover ready and boldly but deliberately step forward and clap on the cover, taking care to fit it so tight to the pot that it will extinguish the flame in a moment, which if it does not lift the cover and try a second time while the assistant throws the carpet over the cover and holds it close for a minute; if that does not put out the flame pour in cold boiled oil, of which there ought always to be 2 gallons in the pouring jack ready at hand, then it will be easily extinguished by raising the cover. Continue setting it on fire and extinguishing it after the space of three or four minutes until when a little is poured into a mussel shell and cooled it looks as thick as treacle: it is then strong burnt oil. Before it is cool, ladle it into the asphaltum and boil the whole for two hours, or until it will roll hard. When sufficiently cool pour in 20 gallons of turpentine or more until of a proper consistence. When this is properly managed it may be made to dry in ten minutes.

A material for impregnating paper, cardboard, cloth, wood and other porous substances, as well as for providing an impermeable coating to all other kinds of bodies, is prepared by Cadoret from the following ingredients:—

*For Impregnation.*

|   | I.      | II.    |
|---|---------|--------|
|   | lb.     | lb.    |
| Rich bitumen . . . . .                      | 60-70   | 60-70  |
| Syrian bitumen . . . . .                    | 4-15.5  | 8-15.5 |
| Rosin . . . . .                             | 3-5     | 3-10   |
| Castor oil . . . . .                        | 0.1-0.8 | 0.2-1  |
| Linseed oil, dégras, or heavy oil . . . . . | 17-25   | 15-23  |
| Sulphur . . . . .                           | ...     | 5-10   |

*For Surface Application.*

|   | lb.   |
|---|-------|
| 1. Rich bitumen . . . . .                                     | 10-20 |
| Syrian bitumen . . . . .                                      | 20-25 |
| Rosin . . . . .   | 1-3   |
| Tar . . . . .   | 1-3   |
| Boiled linseed oil . . . . .                                  | 0.5-1 |
| Hydrocarbon oils (benzine, petroleum or turpentine) . . . . . | 25-30 |
| 2. Syrian bitumen . . . . .                                   | 40-50 |
| Rosin . . . . .   | 0.5-1 |
| Boiled linseed oil or castor oil . . . . .                    | 0.1-3 |
| Hydrocarbon oils . . . . .                                    | 40-50 |

The preparation, incorporated by mixing, is rendered fluid by the aid of heat; and the articles to be treated are either immersed in it or else coated over with the brush. When one or two coats have been laid on cardboard and dried, it is stated that any desired

colour may then be applied, and will firmly adhere, and retain its lustre.

*Stearine Pitch Varnish to Stand High Temperature.*—Ten pounds of red lead and 10 lb. litharge are added to 100 lb. stearine pitch and heated to 400-600° C. by superheated steam for a long time—for six hours—and when it has cooled to 150-200° C. it is thinned down with 4 gallons of petroleum spirit; when it has cooled further down it is diluted to the proper consistency by crude benzol. The varnish, it is claimed, dries hard, lustrous and stands a temperature of over 500° C. (932° F.) dry heat and 250° C. (482° F.) moist heat, a result it is said not attainable in any other way.

*The Manufacture of Black Varnish from Coal Tar on the Large Scale.*—Black varnish is made by selecting a suitable kind of pitch and melting it in a wrought-iron pot over an open fire. A little of the oil may be used to assist the fusion of the pitch. Great care must be taken not to raise the temperature of the molten pitch too much, as that might cause the mixture to froth, or boil over, when the bulk of the oil is added. The proportions may be about 10 parts of pitch to 5 or 6 of creosote oil. When the pitch is sufficiently fluid the oil is cautiously mixed in with constant stirring. A better and quicker-drying black varnish may be made by using some of the lighter fractions, such as carbolic oil from which the phenol has been extracted, or light oil which has been treated for benzene. Still thinner and quicker-drying varnish is obtained by using a proportion of common coal-tar naphtha along with the oil, though it is sometimes difficult to completely incorporate the naphtha without prolonged stirring. Black varnish made in this way is excellent for rough outdoor work, either on iron or wooden structures. It dries to a hard, black and glossy coating. It is also useful for the preservation of roofing felt and a variety of other purposes. A steam-jacketed kettle produces a varnish of a superior quality. Into a kettle fitted with a steam coil, or preferably a steam jacket placed high upon a work bench, put 100 parts by weight of 90 per cent. benzine and to this add 40 parts of coarsely powdered rosin (colophonium), which, if continuously stirred, dissolves very quickly. To this add 90 parts of medium hard coal-tar pitch, also coarsely powdered, and with continued stirring warm the mass up to 50° or 60° C. After stirring from a half-hour to an hour, and in order to prevent further distillation of the benzine, turn off the steam and run cold water through the jacket of the kettle until the heat of the varnish is reduced to the temperature of the day. It may now be allowed to stand for a time. When thoroughly settled, syphon off the clear varnish into a closed vessel somewhat lower down, where it will further clarify itself. At some distance up from the bottom of the vessel there should be a cock through which the clear varnish may be drawn off into barrels. Little or no use has as yet been discovered for the residue, except, perhaps, the mixing of it with coaldust, sawdust or peat to make

briquettes. Attending this process is only one disadvantageous circumstance, *viz.*, the unavoidable boiling away of some of the benzine during the mixing, but if the operation be conducted in a closed receptacle provided with a mechanical stirring device, the distillate may be regained (Fig. 20 this treatise, vol. i., p. 51). A varnish made in this wise possesses good covering powers and a remarkable gloss, besides drying in a few minutes, a quality which is a matter of much importance to the consumer; moreover, it does not scale off smooth surfaces nor is it easily affected by atmospheric changes or conditions.

Aniline colours of all descriptions are derived from coal-tar. These products are not always soluble in alcohol, oil or water, but they are soluble in the results of the distillation of tar. The distillation of tar produces two distinct fluid substances, in either of which the colours referred to are soluble. The distillate of the first operation is designated "first run light tar oil," and the second product "dead oil," either of which are purchasable at a low price. By heating either of the products named in a steam-jacketed kettle, any colouring substance or aniline dye derived from coal-tar can be obtained in concentrated form; such are designated tinctures of aniline colours, and they are also capable of imparting to oil any desired shade, tint or tone. In connection with these specialities an eminent authority on varnish-making says: "If a small quantity of coal-tar blue is dissolved in any one of the oils above referred to—'first run tar oil' or 'dead oil'—a beautiful oil stain will be the result, and a magnificent blue-black varnish can be produced by dissolving in this blue-coloured oil a small quantity of roofing pitch".

There has recently been manufactured in Russia a varnish which protects both wood and iron from the action of moisture by employing the petroleum tars obtained by distilling with steam the tars coming from the acid residues from the refining of petroleum, neutralised by lime, or extracted directly from a petroleum bitumen extensively distributed throughout the Caucasus, in the government of Koutais. The proportions are: Tar, 100 parts; linseed oil, 25 parts; naphtha, 125 parts. It is mixed in the cold, and during the mixing process a little white lead is added. Black varnish can also be made from Scotch shale.

## CHAPTER IX.

### TESTING VARNISH—UTILISATION OF RESIDUES.

ENGLISH varnishes are regarded as better than French, German or Belgian. Though certain French firms have improved the quality of their varnish, French tradesmen, rightly or wrongly, prefer the more costly English varnish. The reason is not far to seek. Raw materials, *i.e.*, resins, oils, driers, spirits of turpentine, are, of course, bought under practically identical conditions in the different varnish-making countries. The difference in quality of the varnish must therefore be due to difference in the proportions of the various ingredients and in the methods of incorporating these with each other, in a word, to manufacturing skill. The low ratio of resin to oil enables the English varnish-maker to use such resins as Zanzibar and Sierra Leone copal instead of the low-priced Manilla so much used in France, because in addition to cheapness the best qualities only take their own weight of oil and thus fit in well with French methods of varnish-making, whereas the durability and brilliancy of English varnish is due to the use of the best grades of resins. As the turnover and capital of English varnish factories are far greater than those of French or German factories, the highest class of matured and well-aged raw materials are alone used, *e.g.*, old tanked Baltic linseed oil improved greatly in quality since purchase. Continental authors regard the British varnish-maker as being very fastidious in the choice of the lumps of resin, and imagine that the hand-picking of resins is a great feature in every well-regulated British varnish factory. Livache says the gum resins even after they have been carefully washed, garbled and assorted, either before exportation or by the gum washer or merchant who supplies them, may again, owing to the large quantity turned over, undergo fresh assortment in which the lumps may be apportioned for any given quality of varnish. But this idea is erroneous, as the illustrations of how the work is carried on show; and if an amateur or small varnish-maker can inspect each lump of resin, the task of doing so on the large scale would increase the cost of varnish-making beyond all bounds. The gum merchant and gum washer see to all such details.

The maturing or aging of varnishes is an important factor. English varnish-makers, having both capital and space, mature their:

varnishes for several years before despatch, a practice which a small factory with but moderate capital and limited space cannot imitate. Recent American factories working on the English style have, however, made varnishes worthy to compete with the best English brands. French and Belgian varnish-makers are following suit.

*Characteristics of Good Oil Varnish* : (1) *Colour*.—An oil varnish ought to be as pale as possible, so that neither the tint nor tone of the colour of the object to which it is applied be appreciably altered by its application thereto. (2) *Brilliancy, lustre and uniformity of dried surface*.—An oil varnish, as a rule, should not dry dull but with great uniformity, lustre and brilliancy. (3) *Clearness*.—It ought to be perfectly clear and transparent and present no turbidity, nor any dulness nor any bloom. (4) *Consistency*.—Its consistency should be such as to allow of its being easily, smoothly and uniformly laid on with the brush, at the ordinary temperature (15° C., say 60° F.). If the varnish be too viscous, especially if resin predominates in the varnish, uneven coatings of unequal thickness are produced (ridges, hair-strokes, etc.), and the dried coating is not uniform and consequently unsightly. On the other hand, if it be too limpid, it runs or flows too easily, and the too thin coat or layer does not when dry present the desired brilliancy; moreover, it runs into streams which are unsightly when dry. Besides, when a quick-drying varnish contains too much resin and too little oil, and is at the same time too viscous, surface-drying, with all its attendant evils (liquid layers beneath, etc.), is very apt to occur. The right consistency can only be gained by practice. (5) *Quick and hard drying properties*.—One of the most important points connected with varnish is its drying properties, and one of the evils to be guarded against is surface-drying. As soon as the varnish is applied to any surface the volatile solvent begins to evaporate and eventually leaves a viscous layer of oil and varnish. Now, this is precisely the point at which great care must be taken to prevent the deposition of dust on the oil varnish, because the latter will fix it permanently, and thus injuriously affect the workmanship of the varnisher if not irretrievably run it. It is at this point again that the tackiness of rosin in varnish with all its attendant evils makes itself felt, unduly prolonging this stage of varnish drying, besides seriously impairing the durability of the varnish. Moreover, it is a long time before the varnish, even after it has completely dried in the ordinary sense of the term, loses its tackiness, as those who have sat on newly varnished church seats know to their cost. Besides, each point where a tacky varnish has come in contact with any object becomes a serious eyesore, so much so in fact that, in aggravated cases, the varnish instead of improving the appearance of the object mars it, and the last state of the varnished object is worse than the first. Nothing is more unsightly and unpleasant than a varnished object that has been handled or exposed to dust or rough usage generally before it has dried, or of a varnished article the varnish of which has been injured by heat, say a polished table, the

spirit varnish of which has been blistered by a hot tea-kettle. But oil varnishes are supposed to stand rougher treatment than spirit varnishes, provided they are made from hard resins, and have been allowed to dry thoroughly. Coming back again to the drying stage the oil in the varnish gradually oxidises so far as to be converted to a certain extent into solid linolin which is incapable of fixing dust. However, the varnish is not completely dry for it sticks to the hand when pressed against it, the more so if considerable pressure be used and the warmth of the hand allowed time to act. By-and-by the films in the underneath part of the coat of varnish absorb oxygen at the expense of the more highly oxidised films on the surface, and so on until all the oil has attained its maximum point of oxidation, and become perfectly dry to the touch, even when the warm hand is applied thereto, under pressure, for some considerable time. The varnish is then said to have dried. Good quality varnish should, it is said, not fix dust after four hours, and should dry completely in twelve hours. Varnish for outdoor work should not fix dust after six and should dry within sixteen to twenty-four hours. On the other hand, carriage varnishes must be allowed ten to twelve hours to resist dust and two to five days to dry, according to the character and function of the varnish. But generally speaking, good varnish and good boiled oil should dry in all situations within seven or eight hours in summer. The weather is the great factor in both oil drying and varnish drying. (6) *Aspect of the dried varnish.*—A coat of good varnish when well applied to an object should impart to the surface throughout its entirety the lustre of a uniform sheet or plate of polished glass, showing no bloom, bubbles or blowholes, patches, streaks nor ridges, nor no break of uniformity, far less should it exhibit any sign whatever of rapid deterioration. Good quality varnish, even when tested several months after its application, ought it is said to be capable of being detached even then in the form of a thin flexible elastic pellicle. But such a varnish we are afraid would be liable to become indented by contact with a rough uneven surface. On the other hand, should the layer when tested as above disintegrate into scales and dust the varnish is of bad quality, too rich in gum resin, and the operator may be convinced that it will be rapidly attacked and destroyed under the action of all those extraneous influences included under the term "weather".

*General Rules Influencing the Quality of Oil Varnish.*—In order to obtain an article exhibiting all the desirable qualities and characteristics just enumerated, it is necessary to pass in review all the predisposing causes which may act upon either the ingredients of the varnish or the manufactured article, so as to profit by those which tend to improve, and to eliminate those which have an injurious tendency.

1. *The colour should be as pale as possible.*—In the manufacture of varnishes from amber and copal, as already indicated, care must be taken to use select parcels, and to "run" the resins with care and

avoid as far as practicable all darkening of the resin. The oil ought likewise to be pale, and it is advisable to use oil which has been "boiled" for a long time at a low temperature, and as far as possible without driers. Finally, the admixture of different ingredients ought to be effected with all necessary care, and at such a temperature that none of them char. Avoid all resins with vegetable débris.

2. *The varnish ought to be perfectly clear and transparent.*—This important quality is obtained by filtration and clarification and by being matured by age; moreover, it is evident that the nearer varnish is to the top of the tank in which the clarification by deposition is going on the brighter and better will be the quality, because the freer it will be from suspended impurities. The presence of too large quantities of driers, even although originally soluble, in the varnish is one of the prevailing causes which militate against its transparency, because the excess of driers is often deposited as the varnish ages.

3. *Consistency and ratio of oil to resin and of both to solvent.*—The desired result may be obtained by using the proper proportion of the solvent; nevertheless, the greater the duration and regularity of the boiling of the mixture of resin and oil the more freely will the resultant varnish flow under the brush, and more regular will the coating be. Varnish dries in a shorter or greater length of time according to the nature of the object or article to which it is applied and the ingredients entering into its composition. In the first place regard must be had to the consistency of the varnish; if in fact the desired consistency has been obtained with *too small a proportion of solvent*, there will be obtained, after evaporation thereof, a thick layer consisting of a mixture of resin and oil through which the oxygen indispensable to the thorough drying of the varnish can only penetrate with difficulty, especially to the very bottom layers of the coating. If, on the other hand, *too much solvent* be used, the resultant layer will be too thin and will only very imperfectly cover and protect the article or object to which it is applied. The indiscriminate use of turps, petroleum spirit or other solvent in thinning varnish so as to make it more easy of application is to be deprecated. But, *ceteris paribus*, the most important factor is the relative proportion of resin and oil; if the proportion of resin be too great, it will, as the varnish dries, very soon exclude the air, and the apparent quick drying of the varnish will result in the incomplete drying of the layers underneath. Accordingly, too quick drying is not always a sure index to a superior quality varnish, the more so as an excess of resin, as will be seen in the sequel, diminishes the elasticity.

4. *Lustre—the varnish when dried ought to have the appearance of glass.*—The ingredient resin imparts this quality. The brilliancy depends upon the nature of the resin and the proportion thereof, and also to a certain extent upon the purity of the oil.

5. *It ought to be flexible and elastic.*—Flexibility is imparted by the use of certain very soft resins, but, over and above, this flexi-



bility and elasticity depend to the greatest extent upon the drying oil, and the greater the purity of the oil and the more skilfully it has been "boiled," the longer will the varnish maintain its flexibility and elasticity unimpaired. Thus it is that copal varnishes, made from very hard copal, are made by the process known as the mixed process (p. 143), and by the addition of a large proportion of drying oil. The greater length of time taken in drying is more than compensated for by the elasticity of the coating obtained. Moreover, this elasticity will be more permanent the less combined linolic acid present, that is to say, the smaller the proportion of drier used in the "boiling"—a prominent feature of the practice followed in the mixed process.

6. *The dried varnish should show no defects.*—The chief defects presented by dried varnish are due either to faults in their manufacture or to their being applied under unfavourable conditions.

7. *Too much oil—Sweating.*—Amongst manufacturing faults mention must be made of too large a proportion of oil; in such a case, some time after the application of the varnish, the surface presents a greasy aspect and the varnish is said to sweat. The same effect is produced when the surface on which the varnish is applied is not perfectly dry. This defect may be remedied by allowing the varnish to dry as completely as possible, so that it may sweat to its fullest extent. It is then rubbed down with an old soft rag or with very finely ground pumice and then a fresh coat of varnish laid on. Owing to the large quantity of oil in the harder and more durable varnishes they are most subject to this fault.

8. *Too little oil.*—If the proportion of oil be not sufficient the varnish shells off, breaking into pieces of variable dimensions. This effect is due to the unequal expansion of the successive coats and to the want of elasticity in the varnish as well as to any excess of driers.

9. *Too much solvent.*—When consistency has been obtained by using too little solvent, the layer remaining after its evaporation is too thick and the surface yields a skin too readily, whilst the layers underneath still remain viscous, bend under their own weight, forming folds and wrinkles.

10. *Too much driers.*—If too great a quantity of driers (especially where hydrated driers have not been rendered quite anhydrous by roasting prior to use) have been used in the manufacture of the oil varnish, and if it has not been allowed to clarify by aging sufficiently long so as to deposit all suspended particles, then each particle becomes the centre of an air bell, thus giving rise to pinholes and striæ, if not to patches.

11. *Bad effect of mixed varnishes.*—If a mixed varnish be used consisting of an admixture of varnishes of different quality and manufacture, owing to their not being homogeneous the layer in drying exhibits several defects.

12. *Manner of application.*—The conditions and circumstances under which the varnish is applied may also affect it. An incom-

petent, inefficient workman will inevitably secure bad results. Without dwelling upon this point, altogether foreign to the principles which underlie the manufacture of good quality varnish, it is, however, advisable to indicate some of the most frequently recurring conditions which exert an injurious effect upon varnish as it is being applied and before it has time to dry.

13. *Too low a temperature.*—Supposing, for instance, the varnish is applied at too low a temperature, then it spots owing to the oil congealing. The varnish is then said to *chill* or *freeze*. Again, on the other hand, should the surface upon which the varnish is to be applied not be properly prepared to receive the varnish, or if it had been soiled or greased by contact with the hands, an unequal coating results, and the varnish is said to *draw* or *pull*. Moreover, under the influence of heat or the sun's rays, especially in the case of surface-drying, the fatty matter expands, and if the volatile solvent is resolved into vapour and thereby prises up the superimposed layers or dried skin of varnish on the surface, the varnish *blows* or *blisters*.

14. *Blooming.*—If moisture condenses upon the still fluid varnish the surface becomes coloured with a velvety surface analogous to that encrusting certain fruits, *e.g.*, the blaeberry. In other words, the varnish blooms or turns blae. Anything which attracts water, such as a deliquescent salt used as a drier, or condensed varnish fumes falling back into the gum pot, or even cold depositing moisture on the surface of the varnish as it dries, will induce blooming.

15. *Noxious gases.*—In conclusion, certain noxious gases generated locally, and met with in the surrounding atmosphere, impart a yellow colour to varnish. In the case of black varnish faked up with blue, as is often done, the yellow thus generated unites with the blue and imparts a decided greenish cast to the black. The yellow colour itself may be generated from the blue by the action of ammoniacal vapours inducing partial decomposition of Prussian blue. Ivory black faked up with Prussian blue should never be used in coach painting. Neither should coaches be varnished in the neighbourhood of a stable, or housed in such a neighbourhood too soon after being varnished. This has given rise to countless disputes and actions at law between coachbuilders and varnish-makers on the one hand and coachbuilders and their customers (often medical men who should have known better) on the other hand.

16. *Benefit derived from the maturing of varnishes by prolonged storing.*—Varnish made in winter, owing to the cold temperature at the date of manufacture, is too fluid in consistency when applied in summer, and thus gives a too thin and too dull a coat. Varnish ought to be stored or aged in an atmosphere more warm than cold. Comparative experiments have shown (p. 127) that varnish aged in a warm atmosphere dries even three times as quickly as that which has been stored in a cold atmosphere. Moreover, the length of time that has elapsed since the date of the manufacture plays a

very important part in the production of good varnish, and ought therefore to be very seriously considered. According to certain practical varnish-makers, no manufacturer ought to put on the market any varnish until after it has been stored and thus aged for several months, and not only so, but the good qualities of the varnish would be still more enhanced by further storage for a couple of years.

This is the cause of the superiority of certain English varnishes which are often kept for three years in the factory before being sent out, and afterwards, in addition thereto, for several years in the depôts or branches, making, say, altogether a lapse of some five years or more between the date of their manufacture and their sale for use; hence the great risk of the bad smell of Russian turpentine when merely masked reappearing and damaging the sale of otherwise good quality varnish.

*Testing of Varnish; General Remarks.*—The testing of varnish to be of any real value ought to be done under conditions analogous to those to which the varnish will be subjected in actual practice, that is, in the condition of a perfectly dry thin layer. Such a layer should be obtained by pouring the varnish on an impermeable medium, say on a glass slab. The glass slab absorbs nothing, and drying therefore goes on uniformly at every point. In the absence of a glass slab a piece of tin plate will do. Nevertheless, it is advisable to make tests on wooden panels painted or stained with colours which the varnish should protect from any wear and tear to which such panels may be subjected. The coat of varnish when it is thoroughly dry ought to adhere firmly to the surface and should not become detached after repeated shocks or vibrations, nor yield to thumb nail. When a piece is detached by a knife it should be flexible and elastic. As the coat ages it should not become dull but preserve its primitive brilliancy without cracking or shrinking, shrivelling or blistering. Moreover, it should not turn yellow.

*Determination of Oil and Resin.*—Attempts have been made to identify the oil and the resin by the ordinary methods of oil analyses, such as iodine and bromine absorptions, but only very unsatisfactory and uncertain results have been obtained. The simplest and most exact process consists in spreading a certain quantity of varnish on a glass slab and when it is quite dry to break it up with an appropriate solvent. Working in this manner linoxin, the oxidised product of linseed oil, being insoluble in all solvents, it is easy to dissolve the resin and after evaporation to weigh exactly the two ingredients, linoxin and resin. From the weight of the linoxin the proportion of linseed oil may be deduced, calculating upon and allowing for an absorption of 15 to 16 per cent. of oxygen by the linseed oil. The different properties of the separated resin may be studied in the usual way, but the presence of infinitesimal quantities of the incompletely volatilised solvent or certain greasy products arising from the incomplete oxidation of the linseed oil

into linolin are drawbacks. The nature of the driers used can only be ascertained by analysing the ash. Borates must be tested for specially. Among the general chemical tests are the following:—

1. When agitated with water the varnish should show no acid reaction which would indicate the presence of fatty acids.
2. The varnish should be completely saponifiable by alcoholic potash; if otherwise, the varnish contains rosin oil or mineral oil.
3. The ash should be infinitesimal. *Absence of Rosinates.*

In some cases it may be of service to ascertain the degree or extent of oxidation which a varnish may have undergone in the interval between its manufacture and application. With this object in view Dr. W. Fahrion has described a process based upon the fact that the non-saturated fatty acids yield on oxidation oxy acids insoluble in petroleum ether and which can thus be separated from the saturated fatty acids or their oxidation products.

*Determination of Spirits of Turpentine.*—The proportion of spirits of turpentine cannot be determined by direct distillation. There always remains a viscous residue, due to oxidation, even if the varnish be distilled off *in vacuo*, or if after the addition of water it be distilled in contact with air. For Flash Point, see vol. i., pp. 104-106.

*MacIlheny's Process.*—The most exact process is that of MacIlheny, which consists in distilling 25 grammes of the varnish in a 400 c.c. flask after adding 100 c.c. of water and some granulated tin to stop bumping. From 90 to 95 c.c. of the distillate are collected, and the spirits of turpentine after separation are measured. A correction must be made for the essence of turpentine retained by the water of 0.35 c.c. in volume or 0.3 grammes by weight for 90 c.c. of the distillate at 15° C. If in place of spirits of turpentine another solvent be used it is detected and determined either by direct distillation or by the preceding method. If the solvent consists of a mixture of spirits of turpentine and petroleum spirit, the process is conducted as before, and after the water is separated the spirits of turpentine is converted by means of nitric acid into substances soluble in water. The unchanged petroleum spirit is separated and weighed (see vol. i., p. 111).

*Varnish Damaged by Sea Water.*—Varnish in bulk damaged by sea water, especially in a muddy tidal river, is resolved by coagulation into an unsightly mess not unlike a linseed-meal poultice. In case of such a complaint confirm cause of damage by testing the damaged product for common salt and sue the shipping or lighterage company.

*The Mechanical Testing of Varnishes: Laurie's method for determining the hardness and elasticity of an oil varnish by finding pressure necessary to scratch the varnish by means of a rounded steel point.*—To test the method a glass tube, 1 in. in diameter and some 8 in. high, was plugged at the bottom with a disc of wood, and a hard steel pin ending in a rounded point protruded centrally from the bottom. The tube and pin were supported vertically by brass

brackets through which they could slide easily. Additional pressure was applied by filling the tube with small shot, and a paper scale on the tube indicated the total weight on the point for various quantities of shot. The method promising to be successful, a more delicate and convenient apparatus was designed (Fig. 47). This fulfilled its purpose so satisfactorily that no change has been made in it. In addition to the inconvenience of pouring in and out quantities of shot, the first apparatus had a minimum reading represented by the weight of the empty tube, and a design was sought which would permit of reduction of pressure down to zero. The mode of applying the pressure is a helical spring fixed at the bottom and pulled out at the top, so that its retractive force draws down a central rod.

A central rod slides easily in a vertical direction through holes in two brackets. The upper portion of the rod has a screw thread, on

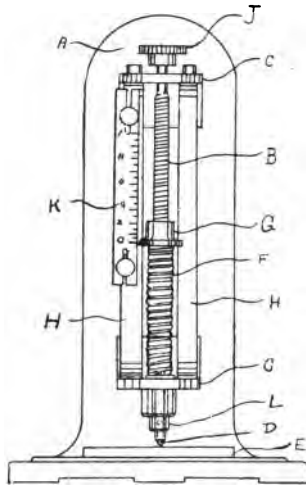

FIG. 47.

which is a running nut. The nut is prevented from turning round by guides which project into the wings of the nut. By a milled head at the top the rod is twisted round, and the nut is caused to travel up and down on the thread. A helical spring of steel wire, slightly pulled out before hardening, is attached at its upper end to the travelling nut, and at its lower end to the lower bracket. Hence the lower end of the spring is the only fixed part of this system. When the spring is in extension it will pull the rod downwards, but by screwing down the nut the pull is reduced, until a point is reached where the spring becomes compressed and commences to lift the rod. To the lower end of the rod is attached a hardened steel blunt point, and the varnished plate to be tested is placed under this. The nut is screwed down or up until the point floats at the height of the varnished surface, which position indicates zero pressure on the plate.

A scale is attached to one of the guides, and a fiducial mark is made on the wing of the nut. The scale has a vertical adjustment, so that its zero can be set to the fiducial mark when the point is floating. In order to prevent a grinding action on the point, the lower thicker part of the rod is made separate from the upper portion carrying the screw thread, and a feather in it, passing through a slot at the side of the guide, prevents rotation. Any arbitrary scale can be used, and the calibration of the scale with a spring of this character is uniform. The spring adopted gave a maximum pressure of 1,200 grammes, or a little over  $2\frac{1}{2}$  lb., but this maximum was required by few of the best varnishes, and a slightly stronger spring will be necessary. The point was rounded to a spherical surface with a radius of 1 millimetre.

While this is an arbitrary shape and size, it seems to suit the requirements of the test as giving due regard to both toughness and hardness. It is probable that examination on the effect of varying the acuteness of the point with points of different shape will give additional knowledge of the properties of the varnish. The point has made many hundred scratches, and when examined under the microscope shows no sign of wear; but there would be no difficulty in fixing a jewel instead of a steel point if any wear should be eventually discovered. The method of experiment consists in drawing the varnished surface across the point smoothly and slowly, the pressure being increased until a white scratch is observed. Even with those varnishes which are substantially dry, a small groove is visible at pressure below scratching, but so long as the transparency of the varnish is not affected such grooving was not regarded as a sign of breakdown. It is, in fact, a sign of toughness in a varnish, and those which did not groove, such as mastic, shellac and resin with insufficient oil, were invariably brittle coatings which splintered at the scratch and gave poor results. To test how far this machine would give results of practical interest, a certain number of trade varnishes and also a certain number of varnishes prepared in the laboratory were tested. The varnishes prepared in the laboratory were made by mixing certain gums, after fusing, with hot manganese oil and diluting with turps. In the first place some varnishes were made up with common rosin, in which the proportions of the oil varied from 2 to 1 to 1 to 2; and some varnishes were also made up from a set of gums, one of which—a hard copal—had been obtained from a firm of artists' colour manufacturers, and the others, *viz.*, gum animé, Kauri and white Manilla, were obtained from a leading firm of varnish manufacturers. These gums could be taken as reliable and fine specimens of the varieties they represent, and from these the series of varnishes already described were prepared. The following is the final method adopted by Dr. Laurie. A sheet of patent plate of ordinary lantern slide size is taken and thoroughly cleaned, and rubbed with chamois leather. It is then placed inside a water-bath oven, along with the sample of varnish to be tested, and the whole

is warmed up. Then the varnish is withdrawn, run on to the centre of the plate, and then carefully distributed over the whole surface with the finger. [The spreading of the varnish by such empirical method as by the finger cannot secure uniform distribution.] The glass plate is again put on the top of the oven for a few minutes to keep the varnish warm and allow it to flow to one level surface. It is then placed in a special cupboard with glass shelves, which have been carefully levelled, where it is allowed to dry free from dust. This cupboard can, if necessary, be heated by means of a current of air which is filtered through glass wool. The results obtained so far are as follows: (1) As an example of a spirit varnish the mastic varnish tested breaks down at a pressure of 1 on the machine already described; and examined through the lens of a microscope, the frac-

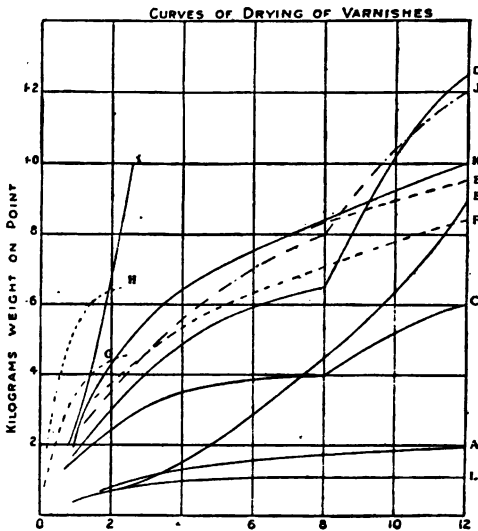

FIG. 48.

ture is conchoidal with certain well-marked characteristics readily recognisable. (2) Oil varnishes made up from common rosin have a hardness varying from 1 to 3, 2 of rosin to 1 of oil having a hardness of from 1 to 1.5, and having a characteristic resinous fracture; while those with an increase of oil, such as 1 to 1 and 1 to 2, show less of the resinous fracture and are on the whole a little harder, or perhaps have greater toughness. The varnishes made from other resins already mentioned require a pressure of from 9 to 12 to cause a breakdown; but these experiments have not been pushed far enough to be able to say that one of the gums used was better than another, although the high reading given by the Kauri was rather remarkable.

The next point of interest was the rate of drying of these various varnishes, as illustrated by the scratching tests. The curves given in Fig. 48 illustrate the great variety found in this matter. The tests

were carried on over a period of twelve months, and it will be noted that a good varnish requires at least this length of time before it has reached anything like its final hardness. After eight months' drying some of the varnishes were heated to a temperature of 70 to 80° F. for a fortnight, which has hastened the drying process. Curve A shows the rate of drying of the rosin varnishes already referred to. It will be noted that the hardening is practically complete in a short time, and after that they show very slight improvement. Curve B shows the drying of a varnish made for artists' use, prepared from manganese oil and a hard copal. It will be noticed that it dries with great uniformity, and has reached its maximum at the end of twelve months. Curve C is another artists' copal, which dries much more slowly. Curve D represents a sample of hard church oak varnish made by a well-known firm. It is evident from the shape of the curve up to the time when artificial heat was applied that this varnish would probably have taken some years to reach its full hardness. Curve E is another hard church oak, very slow in drying. This may again be contrasted with the best carriage varnish of another maker—Curve F. This varnish has only been painted out for some three months, and it will be noted that its rate of rise is much more rapid, though it has probably not yet reached its final point. Curve G is an excellent example of a cheap floor varnish. It is a very rapid drier, but it has already nearly reached its maximum strength, and is beginning to curve over at the end of three months. Curve H is a more expensive floor varnish, equally quick in drying but reaching a greater hardness. Curve I shows a very rapid drier, reaching a high value of hardness.

## RATE OF DRYING OF VARNISHES.

| Curve. | Name of Varnish.         | Maker. | Four Months. | Eight Months. | Nine Months. | Twelve Months. |
|--------|--------------------------|--------|--------------|---------------|--------------|----------------|
| A      | Resin and oil . . . .    |        | 1·2          | 1·7           | 1·9          | 1·9            |
| B      | Picture copal . . . .    | I      | 6·5          | 8             | 9            | 9·5            |
| C      | " " " " . . . .          | V      | 3·5          | 4             | ...          | 6              |
| D      | Hard church oak . . . .  | II     | 4·8          | 6·5           | ...          | 12·5           |
| E      | " " " " . . . .          | IV     | 1·5          | 4·5           | ...          | 9              |
| F      | Carriage " " " " . . . . | II     | 5·5          | 7             | ...          | 8·5            |
| J      | Finest oak . . . .       | III    | 5·5          | 8             | ...          | 12             |
| K      | Maple . . . .            | II     | 6·5          | 8·5           | ...          | 10             |
|        | Amber . . . .            | IX     | 1            | 1             | ...          | 1              |

| Curve. | Name of Varnish.         | Maker. | One and a half Months. | Two and a half Months. | Three and a half Months. |
|--------|--------------------------|--------|------------------------|------------------------|--------------------------|
| G      | Floor varnish . . . .    | VIII   | 4                      | 4·5                    | ...                      |
| H      | " " " " . . . .          | VII    | 6                      | 6·5                    | ...                      |
| I      | Carriage " " " " . . . . | VI     | 4                      | 10                     | ...                      |



The table of figures gives the final results of the tests of these trade varnishes, and of those of Dr. Laurie's own preparation after twelve months. The whole of these here given were submitted to a temperature of 70° to 80° F. for a fortnight during four months.

It will be noticed there is a very considerable variation among these final figures, and it seemed of interest to discover how far exposure to the atmosphere and frost would give concordant results. These were, therefore, exposed to the air for a period of three months. The result was that the amber and the inferior specimen of Copal III showed deterioration at the end of a fortnight, and vanished completely in three months. The hard church oaks and the cheap good oak cracked badly in three months, and the Finest Oak III showed slight peeling. The other trade varnishes were apparently sound and transparent, but on testing their hardness it was found that this had fallen to 1 or 2, and they gave a splinting or crumbly scratch. It is evident that the oil had completely deteriorated in this space of time, and the varnish was practically worthless as a protective covering. It is possible that the fact of the varnish being on a non-absorbent surface may have increased the tendency to decomposition, and that if laid on to wood or on to a surface of paint, the life would have been longer. The test is of interest as showing that decay

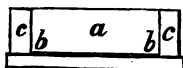

FIG. 49.

may set in long before any outward sign can be detected, and it is probable that a test of the hardness during exposure will give more exactly and more rapidly information as to the durability of varnishes in exposed situations. It is, of course, obvious that lacquers, enamels, japans and paints may be tested in the same way, but these were not, up to April, 1906, examined by Dr. Laurie.

*Improvements in Apparatus for Measuring the Resistance to Scratching of Varnishes, Lacquers and the like.*—A. P. Laurie, Monkwood, Colinton, and F. G. Baily, Newbury, Juniper Green, Midlothian, claim in their British patent specification: The use of a blunt point applied with a known and variable pressure to a surface covered with varnishes, enamels, lacquers and the like, for determining by scratching the hardness and toughness of the covering layer. For the purpose of testing varnishes and the like, the combination of a sliding shaft and running nut or collar floating on an open helical spring fixed at the bottom, and attached to the nut or collar above, by which means the weight of the shaft and other moving parts is supported by the spring in compression, and a known pressure is applied at the point of the shaft by the spring, when it is caused to be more extended. The apparatus for determining by scratching the hardness and toughness of varnishes and the like, substantially as described and illustrated.

*Jahns' Method of Testing Varnish.*—Lohmann describes a method originated by Jahns by which comparative data may be obtained based on exact measurement. To a very smooth glass slab (*a*, Fig. 50) is gummed a framework of well-sized glazed paper having exactly the same thickness as that of the coat of varnish it is desired to obtain, say 0.1 m/m. The glass slab having been fixed perfectly horizontally a quantity of varnish is run into the space (*a*, Fig. 50) confined by the paper and sufficient to cover that space. Another smooth glass slab with carefully filed edges is cautiously slid over the surface of the framework so as to eliminate the excess of varnish. When the edge of the latter slab touches the fourth side of the frame the varnish is sucked up by filter paper so as to prevent it running back. There is thus obtained a coat of varnish enclosed within the paper framework of uniform thickness, and precisely equal to that of the paper employed for the purpose, or the excess of varnish may be removed by tilting the plate, etc., as shown at *a*, Fig. 6. The glass slab used to

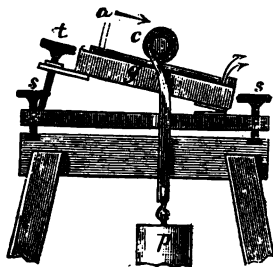

FIG. 50.

remove the excess of varnish is now removed and the varnish allowed to dry within the framework. The varnish may be tested for brilliancy, transparency and hardness by resistance to the thumb-nail. The plate is of course throughout handled on places other than that on which is the varnish to be tested.

It is often useful to ascertain the action of variations of the weather upon varnishes. This may be easily done in the following way: The glass slab used in the preceding experiment is thoroughly dried and then heated for forty-eight hours in a hot air or water bath at 100° C., and during the interval successive currents of dry air are caused to pass through the bath to assist oxidation, and thereby cause as complete drying of the coating as it is possible to obtain. On the coat of varnish, treated in this manner, fresh determinations of colour, elasticity, etc., are made.

*Testing Hardness and Elasticity.*—Again, the varnish may be tested as to its resistance and elasticity by the use of special apparatus. This consists of a small cylinder (*cc*, Figs. 53 and 54) capable of being rolled over the preceding glass slab. The weight

of the cylinder may be varied by placing in its interior small bars of lead or it may be weighted by attaching a known weight  $p$  to a metal stirrup. To the circumference of the cylinder are fixed two blunt ring-shaped knife edges  $dd$ . It will be easily seen that as the weighted cylinder is rolled over the layer of varnish acting downwards like a wedge, it will leave tracks corresponding to the knife edges, which will vary with the weight of the cylinder and the hardness and elasticity of the varnish. The roller  $c$  is brought into contact with the plate to be tested by working the screws  $ss$ , and the plate is so adjusted that the ledge  $x$  lies horizontal whatever the inclination of the arrangement when the small tongue  $z$  encounters the catch near  $n$ . The blunt roller knives then press on the layer of varnish, and by tilting the support  $g$  by manipulating the screw  $t$  the knives

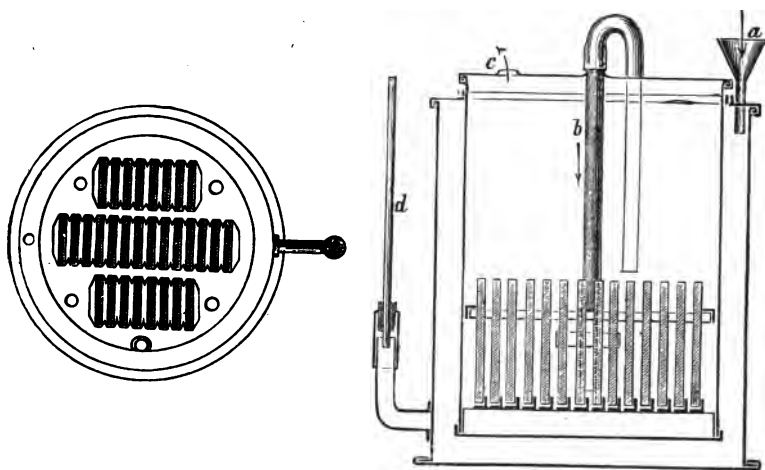

FIG. 51.—Water Bath for drying and oxidising samples of Varnish to be tested for durability (ground plan).

FIG. 52.—Section of Fig. 51: (a) funnel for water, (b) air injector, (c) air escape, (d) water level.

are caused to roll. The softer the varnish the deeper it will be pierced. The harder the varnish the more shallow the impression. The width of the track  $b$  (Fig. 54) is also a measure of its elasticity. If the weight on the cylinder be now increased so as to cause the knife to pierce completely through the layer of varnish, it will then roll upon the glass so as to be decomposed into the normal resultant pressure (N Fig. 54b) exerted on the coat of varnish H F. The force H seeks also to separate the varnish from the glass, and the resulting resistance is the adhesion of the varnish to the glass. If it be great after being subjected to the force exerted to separate it from the glass it gives under the microscope negative results. Nothing is observed; not even by shifting the light about can any vacant space be discovered. If the adhesion be weak a space is formed (Fig. 54c), which shows up under

the microscope, and at the same time afford valuable data as to the force with which the varnish adheres to the glass. The microscopic examination of the cracks or striæ thus produced will, with a little practice, enable the operator to decide exactly the quality of the varnish submitted to the test. By the force  $V$  a bending, blurring and compression of the fine layer into various contortions by the point of the wedge is produced according to the elasticity of the varnish.

Under the microscope *superfine* varnishes show, besides the main indentation cut in the coat, two streaks on both sides which appear

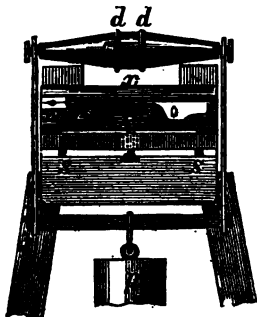

FIG. 53.

wholly and uniformly shaded and surrounded by fine dark or pale straight lines (p. 193, Figs. 1, 2, 3). *Fine* varnishes show, besides the main indentation, two streaks on both sides which are irregularly shaded and a separate dark streak near the main indentation or the strongest shaded part of the centre of the streaks (Figs. 5-7). Sledge varnish, besides the main indentation, shows two streaks on both sides which exhibit wrinkles (Figs. 9 and 10). Japan (Fig. 14) behaves

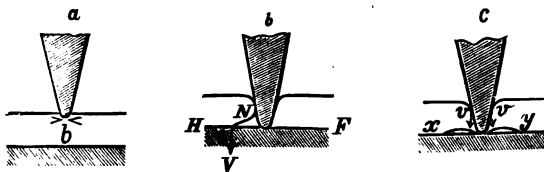
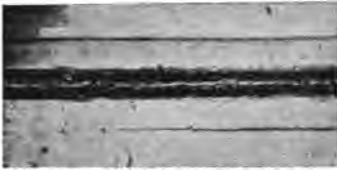

FIG. 54.

like the above. The detail of the shading does not come out, as the red-brown layer even highly diluted completely absorbs the active rays. The cause of these appearances and the inference to be drawn therefrom are: The coat given by superfine varnishes 1, 2 and 3 is highly uniform; the varnish is made from homogeneous material. It is very elastic. The wedge-shaped knife under the working pressure appears to penetrate quite uniformly through the whole breadth of the uniformly shaded streaks. Fig. 3 is a locomotive varnish; it has the character of a superfine varnish adapted for its particular use since it shows a greater elasticity than Fig. 1, and

**MICROSCOPICAL ILLUSTRATIONS OF THE MECHANICAL TESTING  
OF VARNISHES BY JAHNS' METHOD.**



**FIG. 1.**



**FIG. 3.**



**FIG. 2.**



**FIG. 4.**

**SUPER-FINE VARNISHES.**

MICROSCOPICAL ILLUSTRATIONS OF THE MECHANICAL TESTING  
OF VARNISHES BY JAHNS' METHOD (*continued*).



FIG. 5.

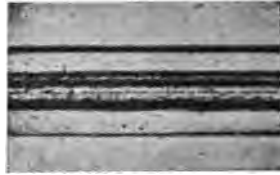

FIG. 7.



FIG. 6.

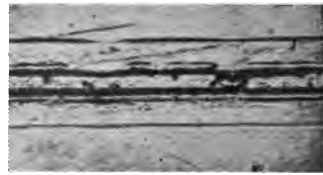

FIG. 8.

FINE VARNISHES.

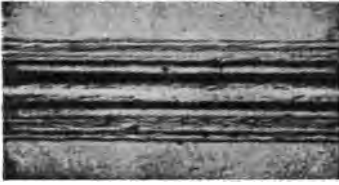

FIG. 9.

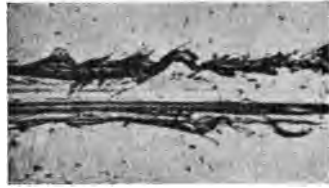

FIG. 11.

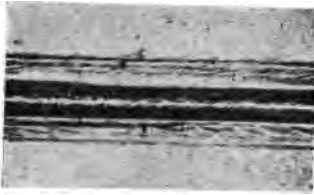

FIG. 10.

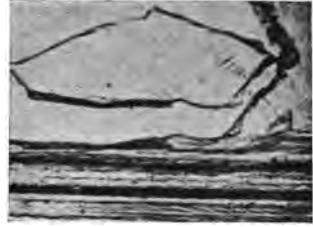

FIG. 12.

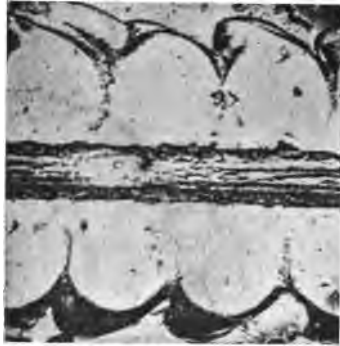

FIG. 13.

FINISHING VARNISHES.

MICROSCOPICAL ILLUSTRATIONS OF THE MECHANICAL TESTING  
OF VARNISHES BY JAHNS' METHOD (*concluded*).



FIG. 14.



FIG. 15.



FIG. 16.

JAPANS.



uniform shading under the side pressure of the ring-shaped knives. *Fine* varnishes (Figs. 5, 6 and 7) give a less uniform layer, as the raw material is less homogeneous, since the pressure of the wedge-shaped knife does not penetrate uniformly through the whole breadth of the streaks, besides the main indentation is deep. The dark streaks were in this case produced by unequal pressure. Varnishes 5 and 6 are more elastic than that in Fig. 7, since the streaks of the former have a greater breadth than those of Fig. 7. The sledge varnish (Figs. 9, 10) is still less homogeneous than the *fine* varnishes. The uniformity of the side pressure of the knives is distorted for want of elasticity. The pressure of the knives on the material is such that it displaces it and thus begets wrinkles. It follows from the nature of varnish-making that various intermediate qualities are produced differing therefrom to a greater or less extent; this is shown in Fig. 4, which represents a varnish between *fine* and *superfine*, as it shows light shades on the streaks besides the main indentation. Fig. 8 is a fine varnish approaching sledge varnish in quality, as it shows the formation of fine wrinkles. As to the appearance of the abnormal varnishes the following observations may be made: Fig. 11 shows a sledge varnish like Figs. 9, 10. Visible wrinkles are produced in the whole mass thereby causing rupture; adhesion is no longer satisfactory nor the uniformity of the under layer undisturbed, since on both sides of the main indentation undulatory ridges are produced, showing the separation of the varnish from the under coat. Fig. 12 shows a sledge varnish which likewise shows unsatisfactory adhesion to the under layer, as a piece of the varnish coat has been loosened. Fig. 13 shows a sledge varnish which being inelastic adheres in a highly unsatisfactory manner, as in the abrasing action of the ring-shaped knives a continuous severance of conchoidal splinters occurs. The poorer the degree of adhesion the greater is the space between the conchoidal splinters. Figs. 15 and 16 show similar behaviour of poor Japans.

## CHAPTER X.

### UTILISATION OF VARNISH-MAKERS' WASTE PRODUCTS.

ACCORDING to Andés, the waste products formed in the manufacture of varnishes comprise the following: (1) Waste (*a*) from the sorting and crushing of copal (very impure pieces, fragments and dust). Waste (*b*) from the washing with lye. (2) Resin, oleo-resin, etc., adhering to the sides of the casks and packages. (3) The skins on varnish and boiled oil. (4) The sediment from ran linseed oil and boiled linseed oil, linseed oil foots. (5) Residues from the melting of copal. (6) Copal oil. (7) Sediment from fatty varnishes, driers, etc.; varnish foots. (8) Waste from the careless melting of copal. (9) Varnish that has become too thick. (10) Odds and ends of varnish and paint. (11) Impure turpentine and dirty spirit. (12) Sediment in freeing linseed oil from mucilaginous matters.

1. (*a*) *Waste Obtained in the Sorting and Crushing of Copal.*—Owing to the great variety of copals, there is considerable difference in the purity of the individual lumps, their size, and the quantity of fragments and dust that form during transport and re-packing, or are added intentionally to the bulk. Each kind of copal is, therefore, on being unpacked at the factory, first passed over a fine sieve to separate the dust from the lumps; or the operation may be performed with a coarse sieve first and a fine one last. All the lumps smaller than a pea are unsuitable for melting, because, especially in the case of unwashed kinds, such as natural red Angola copal, they are covered with a thick encrustation, become very dark, and yield badly. These small lumps are, therefore, set aside, to be afterwards ground along with the fragments produced in the crushing. True, in some works the lumps and dust are all melted together, but this must be done in large melting-pots, and then only at the top, since, if placed at the bottom of the pot, the dust will burn or char and darken the colour of the rest. Organic matters, *e.g.*, fragments of bark and twigs, leaves, etc., are carbonised by the heat employed in the melting process, and thus darken the colour of the product. Hence, to produce pale varnish, these must be eliminated, even though some of the copal adheres thereto. This waste is ground like the preceding, and furnishes either pale or more or less highly coloured spirit varnishes; some kinds, *e.g.*, that from Sierra Leone copal, by treating with tur-

pentine the portion insoluble in alcohol, will furnish perfectly water-white copal varnishes, which are far preferable to those obtained from gum dammar. This treatment gives much better results than melting these impure lumps down to form oil varnishes. One prime essential to the dissolving of copal waste, except that from East African copals (Zanzibar, Madagascar, Mozambique, Lindi, etc.), is grinding to a fine dust. Many of the copals that, like the red Angola, Accra and other sorts, are covered with a thick encrustation, contain a very high percentage of insoluble matter, so that it is often considered a waste of spirit to attempt to treat them by this process. This, however, is a mistake, since the whole of the spirit can be recovered. The preparation of spirit varnish from copal dust is well known, and often only a little artifice is needed to convert a seemingly insoluble dust into a good varnish.

(b) Waste resulting from washing the copal with carbonated or caustic alkali remains to be mentioned under the present head. This process partly dissolves and partly softens the weather-crust, and as the pieces are stirred up and rubbed against one another, some of the copal itself dissolves, while the fragments of the crust accumulate at the bottom of the vessel. These latter are collected on a fine sieve, washed with water, dried and used as above for making spirit varnish. The copal dissolved in the lye is recovered by adding about 3 lb. of concentrated sulphuric acid to every 200 lb. of lye, gradually and with constant stirring. The copal is allowed to settle to the bottom, the supernatant liquid being then run off and the sediment washed, dried in sacks, ground, and used for spirit varnish. In this way from 5 to 8 per cent. of copal is recovered. By precipitating the copallate of soda by manganese sulphate a true manganese resinate would be obtained utilisable as a high-class drier.

2. Rosin clinging to the staves of a cask or the sides of a tank usually contains a good deal of water. It is scraped off clean, and melted to dry it, or ground and sold to, say, bacon curers, for singeing pigs. It can also be used for making white pitch, or in places where they refine rosin oil it can be dissolved in the rosin-soap before it is decomposed with acid. It thus increases the precipitate, and hence the yield of distilled oil. Empty oleo resin barrels should be set in the sun or in a warm place. The heat will melt the oleo resin and make it collect at the bottom so that it can be more completely and quickly got out. Elemi cases should be treated in the same way. Rosin staves boiled in soda lye give a solution of rosinate of soda which can be used to make rosinate of manganese.

3. Skins from oil or those left in pans after hot oil has been poured from them, are often fairly thick, and are usually thrown away or put to quite subordinate uses. If, however, they are taken before they get too dry, they dissolve well in turpentine, benzole, etc., and make a varnish which is excellent for waterproofing and for mixing with pigments. If the skins are boiled in raw linseed oil, they make the oil very drying and act very quickly. A little

sediment is left which should be used as fuel. Varnish skins should be dissolved and added to fresh lots of the same varnish.

4. These sediments consist when from raw oil principally of mucilaginous matter. Mixed with boiled oil, they are excellent for the manufacture of cements, but dry very slowly. They are also very good for making soft soaps, and soap boilers will also buy them willingly. Sediment from boiled oil on the other hand is very drying, and is therefore most useful in the preparation of dark oil colours (its own colour prevents it from being used with light shades) and for cements. It is also valuable for soap, but probably yields more profit when employed in the ways first mentioned. The sediment can also be separated by a filter press, ground and used as a colour. When the oil, too, has had much lead dissolved in it, to make it drying, the sediment, if unfit for soap-making, can even be profitably worked for lead.

5. The residues from copal-running consist exclusively of carbonised vegetable impurities containing some of the copal absorbed, and small quantities of sand and other mineral matter. They are usually used as fuel. It does not pay to wash them with turpentine, as they retain some of the solvent, although the copal is washed out of them. The recovery of the absorbed turpentine is very difficult, because most of it evaporates before there is a sufficient accumulation of residues to be worth distilling. One way of profitably employing the residues is to sell them made up with sawdust into briquettes or "fire-lighters". Small factories, however, do best by using them as fuel on the premises, and so lessening their coal bills.

6. Copal oil, resulting from the heating of copal, can only be completely saved when the copal is run in stills, and this should always be done. Even when the copal is melted in a vessel with a gutter-edged cover, only the least volatile part of the oil is saved. Besides, the oil causes a nuisance in the neighbourhood of the factory, depositing itself as a sticky evil-smelling layer on clothes hung out to dry, on windows, and on everything else that it can reach. Of the 15 per cent. or more of the weight of the copal which must be driven off before the copal becomes soluble, not more than two can be saved by the gutter-edged cover, and that consists solely of the least valuable part of the oil. When a still is used, it is quite easy to find out what percentage of its weight any given copal must lose to make it soluble, by means of a laboratory experiment with an ounce or two. This being known, and also the weight of the copal put into the still, the operation is stopped when the distillate amounts to that percentage of the weight of the resin used. As is well known, the copal is spoiled by heating longer than is necessary, becoming decomposed and dark in colour. It has been suggested to regulate the heating of the copal so as to be able to collect the different fractions of the copal oil separately. This saves all the time, labour and fuel which would otherwise be expended in re-

distilling and separating the constituents of the oil each for its special purpose.

Copal oil is an excellent solvent for soft and medium copals, and can be used to give the smell of copal to the cheaper varnishes. When freed in great part from its odour by rectification it can be used as a vehicle for oil pigments.

7. These residues are mixed with lampblack and run through the paint mills. Useful pigments can thus be made if the residues are free from "skins". Paint residues and skins full of lead can be made into driers by heating.

8. Spoiled runs will not dissolve in turpentine although they will do so in linseed oil. The best way to use the undissolved fused copal is to fuse it once more with its own weight of rosin and make it into a lower grade varnish. Copal burnt by overheating is quite worthless.

9. These products are best heated up in an enamelled pan till they are fairly thin and then diluted with oil of turpentine.

10. These residues should be freed from the varnish clinging to them in a filter press. The press-cakes are best used, mixed with sawdust, as a fuel. Deposits from driers are used as oil pigments. They are separated by a press, dried and ground. Before grinding, however, they must be coarsely powdered and sifted to remove the coarser impurities, which spoil the work of the colour mill, and cause the pigment to give unsatisfactory results in use. Common-sense will also show that dark-coloured deposits should be treated and used separately from light-coloured ones.

11. These can be used too for cleaning vats, gum-pots and machinery where the paint has not dried, when soda lye is the best solvent. They can also be used for common or dark varnish and for Brunswick black. The residues from them are collected and pressed, and the cake, mixed with sawdust, made into block fuel. Such dirty solvents can also be purified by redistilling them, and the residue made with sawdust into briquettes.

12. These dry rapidly and can easily be made into paint by the paint mill.

TABLE SHOWING THE SOLUBLE CHEMICAL AND PHYSICAL CONSTANTS OF SEMI-HARD AFRICAN COPALS (COFFIGNIER).

|                      | Benguela.                | Angola<br>(white).      | Angola<br>(red).          | Congo.                   | Sierra<br>Leone.         |
|----------------------|--------------------------|-------------------------|---------------------------|--------------------------|--------------------------|
| Sp. gr.              | 1.058 at 16° C.          | 1.055 at 17° C.         | 1.066 at 17° C.           | 1.061 at 17° C.          | 1.072 at 19° C.          |
| M. pt.               | 165° (softens<br>at 65°) | 95° (softens<br>at 45°) | >300° (softens<br>at 90°) | 195° (softens<br>at 90°) | 130° (softens<br>at 60°) |
| Acid value           | 123.1                    | 127                     | 128.3                     | 132.3                    | 110.2                    |
| Saponif. value       | 157.1                    | 159.9                   | 131.8                     | 131.8                    | 123.4                    |
| Ethyl alcohol        | 16.5                     | 15.1                    | 38.6                      | 25.3                     | 62.3                     |
| Methyl alcohol       | 46.9                     | 46.7                    | 68.0                      | 55.3                     | 49.2                     |
| Amyl alcohol         | 0.9                      | 1.4                     | 7.0                       | 2.2                      | 4.8                      |
| Ether                | 43.7                     | 27.3                    | 51.2                      | 48.3                     | 47.8                     |
| Chloroform           | 47.3                     | 43.7                    | 65.7                      | 59.6                     | 52.4                     |
| Benzene              | 65.6                     | 50.5                    | 70.0                      | 60.1                     | 56.9                     |
| Acetone              | 24.8                     | 5.4                     | 5.5                       | 45.8                     | 40.3                     |
| Oil of turpentine    | 68.8                     | 69.4                    | 77.0                      | 68.2                     | 71.4                     |
| Benzaldehyde         | 14.1                     | 4.3                     | Soluble                   | 48.7                     | 1.5                      |
| Aniline              | 0.9                      | 3.5                     | 2.3                       | Soluble                  | 0.7                      |
| Amyl acetate         | 1.2                      | 2.7                     | 4.2                       | 0.9                      | Soluble                  |
| Carbon tetrachloride | 74.0                     | 61.3                    | 77.7                      | 66.1                     | 70.9                     |
| Oil of cajuput       | —                        | 9.9                     | 15.6                      | —                        | —                        |

## INDEX.

### A.

*Abietinæ* (Coniferæ), 12.  
 Abietinic acid ( $C_{19}H_{29}O_2$ ), (M.P., 165° C.), 21-24.  
 Accra copal, 9, 56, 61, 65, 67, 68.  
 — — varnishes, 132.  
 Accroides, gum, 6, 9.  
 Acetic acid ( $CH_3CO_2H$ ), (D. = 1.056 at 15.5° C.; B.P., 119° C.; M.P., 17° C.), 18, 20, 49, 52.  
 Acetic anhydride ( $CH_3CO$ )<sub>2</sub>O, (D. = 1.073; B.P., 138° C.), 22.  
 Acetone ( $CH_3COCH_3$ ), (D. = 0.792; B.P., 56.3° C.), 8, 50, 51, 52, 53, 60, 67, 72, 73, 87.  
 Acetyl chloride ( $CH_3CO.Cl$ ), (D. = 1.305; B.P., 55.6° C.), 22, 23.  
 Acetyl derivatives, 22, 23, 52, 53.  
 Acid—abietinic, 21-24; acetic, 18, 20, 38, 52; benzoic, 7, 8; butyric, 18, 49; capronic, 18; carbonic, 21; cinnamic, 7, 8; copalic, 49; dammaric, 73; dammarylic, 73; hydrochloric, 22; isotrachylic, 52; Kaurinic, 74, 75; Kaurinolic, 74, 75; Kaurolic, 74, 75; Kauronolic, 74, 75; mancopalenic, 84; mancopalinic, 84; mancopalolic, 84; metacetic, 18; nitric, 19; oxalic, 46, 52; picric, 52; pimaric, 23, 24; salicylic, 57, 164; succinic, 18, 19, 21-25; succino-abietinic, 21-25; succinosylvinic, 21-25; sulphuric, 15, 72; trachylic, 50-52; valerianic, 18.  
 Acid value (milligrammes of KHO to saponify the free acid in 1 gramme of resin) of copals: Akra, 65; Brazilian, 87; Cameroon, 68; Columbian, 87; Demerara, 87; Kauri, 74, 75; Madagascar, 60; Manila, 84; Pebble, 68; [petroleum pitch, 38; stearine pitch, 38]; Zanzibar copal, 38.  
 Acrolein ( $CH_2.CH.CO.H$ ), (B.P., 52.4° C.), from stearine pitch, 38.  
 Adhesion test for dried varnish, 1, 84, 192.  
 African copals, East, 47-61; West, 61-70.  
 Aging of linseed oil, 176; of spirits of turpentine, 129-62; of varnish, 127, 128, 160.

Air, action of, on essential oils, 7, 8, 9.  
 Akra copal. See Accra Copal.  
 Albane ( $C_{40}H_{64}O_2$ ), 39.  
 Alcohol, absolute, 46.  
 — amylic ( $(CH_2)_2CH.CH_2.CH_2.OH$ ) (D. = 0.825 at °C.; B.P., 129° C.), 46, 49-67.  
 — ethylic ( $C_2H_5HO$ ), 20-25, 45, 49-54, 66, 67, 72-75, 78, 80, 83-87.  
 — methylic ( $CH_3.OH$ ), (D. = 0.789 at 0° C.; B.P., 66-67° C.), 60, 67, 72, 87.  
 Alcoholic extract of amber, 21.  
 Aldehyde, 50.  
 — acrylic. See Acrolein.  
 Alizarin dyeing of amber, 15.  
 Alkalies, action of, on resins, 4, 8.  
 Alkanet root, 15.  
 Amber, 9, 11-29; action of heat reagents and solvents on, 15, 18, 20; adulteration of, 15; agate, 14; alcohol test for foreign resin in, 16; American, 13; artificial musk from oil of, 19; bastert, 14; blocks from small waste, 17; bone, 14; borneol from, 18-23; borneol-succino-abietinic-acid-ester, the last residue of essential oil, of ambers, 21; botanical origin of, 12; Burmese, 13; cajeput oil, test for, 15; camphor, 18, 20, 22; cementing, 15; cloudiness and opacity of, removing, 15; colour of, 14; copal, sophistication of amber with, 15; density (sp. gr.), 11, 15; destructive distillation of, 18-25; dredging, 14; drift, 12; ductility of heated, 15; electrical properties, 15, 16; ester value, 15; fire-heated retorts, etc., for melting and condensing fumes, 26; fluorides, adulteration with, 16; fractional distillation of, 19, 20; fractional solution of, 20-25; fusibility of, 15; fusing, 25-29; gas-heated retort, etc., for melting and condensing fumes, 27; genuine, differentiation of, from consolidated waste, 17; geological horizon of (Greensand formation), 12; hardness, 9, 11, 15; history of, 11; marine, 14; melting of, 25-27; melting-point, 25-27; moulding, 15; musk, artificial, from oil of, 19; oil of, 18-20; oil of, action of bleaching agents

- on, 18-20; oil of, rectification of, 19, 20; optical tests for purity, 16, 17; ornaments, 16; potash, action of, on amber pines (succiniferous), 12, 22; press for consolidating waste, 17; pyrosuccin, 18; pyrosuccin varnishes, 25-29; resiniferous vessels of succiniferous pines (succinosity), 12; resin acids of: succino-abietinic acid, 21-24; succinosylvinic acid, 24; resinols (resenes): succino-abietol, 22-24; succino-resinol, 24; scratch test for, 16; Sicilian, 16; smell of, 15; solubility of, 23; sulphur, test for, in, 15, 23; sulphuretted hydrogen evolved from heated, 15; taste of, 15; varieties of, 11, 14, 19, 20; varnishes, 27-29.
- American (S.) animé, 42.
- Ammonia, 20, 73.
- Amyl acetate, 7, 46, 60.  
— alcohol. See Alcohol, Amylic.
- Andres' colourless copal varnish, 141.  
— plant for fusing copal, 107-9.
- Angola copal, 9, 10, 42, 43, 52-54, 61, 96, 97.  
— — varnishes, 132.
- Angolates, lead and manganese (true resinates), 46, 50, 51.
- Aniline, 46, 50, 51, 61, 67, 87.  
— dyes, 15, 164.
- Annatto, 28.
- Anthracene, 36.  
— oil, 35, 36.
- Antifouling composition, 3.
- Appliances, sundry, for varnish-making, 116.
- Arabs and history of copal, 41.
- Aromatic dammar, 78.
- Artificial leather, 6.  
— musk, 19.
- Ash of amber, 18; asphaltum, 32; coal-tar pitch, 30; copal, 49.
- Ashanti copal. See Gold Coast Copal.
- Asphaltum, 30-34.  
— varnishes, 170-76.
- B.**
- Balata, 6.
- Balsams, 7, 8.
- Bastard Angola copal, 67.
- Bastert amber, 14.
- Beckerit, 11.
- Beeswax, 2.
- Bending test for dried varnish on tin, paper, leather, etc., 3.
- Benguela copal, 9, 10, 42, 48, 61, 64, 67.  
— — varnishes, 152.
- Benin copal, 43, 61, 65.  
— — varnishes, 15.
- Benzoic acid ( $C_6H_5COH$ ), (D. = 1.086 at  $0^\circ C.$ ; B.P.,  $179.1^\circ C.$ ), 67, 87.
- Benzol, 20, 34, 49, 50, 52, 53, 67, 69, 84, 87, 164.
- Bitumen, 12, 31-34.
- Black fir, oleo-resin of, 22.  
— varnishes, 170-76; Berlin—see Brunswick; blue-black varnishes, 76; Brunswick, 173, 174; cycle, 175; enamel, 175; ironwork, 170-76; Japan super-black, 171-73.
- Blast furnace pitch, 6.
- Boiling oil, 122, 123.  
— varnishes (gum dissolved in oil prior to adding turps), 124, 126, 137, 154, 155, 158, 159.
- Bombay copal. See Zanzibar Copal.
- Bone amber, 15.  
— pitch, 6, 37.
- Borneo copal, 9, 47.  
— — varnishes, 153.
- Borneol dextro and levo from amber, 18, 21-24.  
— succino-abietinic acid ester, 22.
- Borowski's amber solution plant, 25, 26.
- Botanical (paleontological) source of amber, 12; gutta-percha, 39; india-rubber, 39; of Copals: Animé, 42-47; Kauri, 75-78; Madagascar, 47-57; Manilla, 81, 82; West Africa, 61-63; West India, 84-87.
- Brilliance of varnish, 121.
- Burgundy pitch (pine oleo-resin boiled with water), 6, 9.
- Burmese lac (natural varnish), 2.
- C.**
- Cajeput oil, 15, 45, 46.
- Calc spar (scratch test), 43.
- Calcutta copal. See Zanzibar Copal.
- Cameroon copal, 65, 66, 67, 68.
- Camphor, amber, 18, 20.  
— smelling resin, 61.
- Camphoretted alcohol, 46.  
— turps, 46.
- Canada balsam, 6.  
— — substitute, 86.
- Carbolic acid. See Phenol.  
— oil, fraction of coal-tar, 35.
- Carbon disulphide ( $CS_2$ ), (D. = 1.293 at  $^\circ C.$ ; B.P. =  $45^\circ C.$ ), 20, 36, 39, 49, 51, 52, 69.  
— tetrachloride ( $CCl_4$ ), 60, 67, 73, 87.
- Carbonic acid gas,  $CO_2$ .
- Celluloid, 6, 15.
- Ceresin, 40.
- Cesalpinæ, 10.
- Champagnet's rubber varnish, 163.
- Chilling of varnish, 182.
- Chinese lac, 2.  
— wood oil, 7.
- Chloral hydrate, 46, 73.
- Chloroform ( $CHCl_3$ ), (D. = 1.526; Freez. Pt.,  $-70^\circ C.$ ; B.P.,  $61^\circ C.$ ), 16, 20, 23, 24, 25, 31, 49, 50, 51, 52, 69, 86, 87, 164.
- Choice of linseed oil, 122; of resins, 122.



- Chromic acid mixture, action of, on amber oil, 19.
- Clarification of linseed oil, 122.  
— — varnishes, 138-40.
- Coal-tar distillation, 84-86; coal-tar pitch, 84-86; 173-76; coal-tar varnishes, 173-76.
- Cochin china copal, 9.  
— — wood oil, 7.
- Colour of amber, 13, 14, 15; of copals, 43, 54, 57, 60, 64, 65, 67, 69, 72; of varnishes, 120.
- Columbian copal, 87.
- Composition of resins: amber, 19-25; Kauri, 73-75; Manilla, 83, 84; West Indian animé, 85, 86; Zanzibar copal, 49-54.
- Congo copal, 9, 43, 62, 66; varnish, 66.
- Copaiba Conjugata* (Bolle), 57, 63.
- Copaifera Gorskiana* (Benth), 57, 63.  
— *Mopane* (Kirk), 61.
- Copal, acid value of. See Acid Value of Copals; arboriculture of, 77; adulteration of, 47; air, action of, on fresh fracture of, 43; air cavities in, 44; buying, precautions in, 47; candle-flame test, 15; cleansing and grading, 56, 57; condensing fumes of, 104-13; crushing, 89-93; definition of, 41; density, 44, 68; dry distillation (partial) essential to render soluble in linseed oil, 96; fracture, 43; fusibility, 44, 64, 66; fusion of, by steam in closed vessels, 109-13; fusion of, by super-heated air, 111; fusion of, in open pots over naked fire, 111-17; goose skin of, 56; hardness of, 43; hardness of, tests for, 43, 44; loss in fusing, 96, 97; melting of. See Fusing; melting-point, 44, 68, 87; oil. See Amber Oil; origin of, 40; properties, 43-47; pyrocopal, 92, 93; running. See Fusion; solubility of, in various solvents. See Acetic Acid, Acetic Ether, Acetone, Alcohol (Amylic, Ethylic, Methyl), Amber Oil, Amylic Acetate, Aniline, Benzaldehyde, Benzol, Cajeput Oil, Camphorette Alcohol, Camphorette Turps, Carbon Disulphide, Carbon Tetrachloride, Chloroform, Copal Oil, Ether, Lavender Oil, Nitric Ether, Petroleum Ether, Rosemary Oil, Spirits of Turpentine, Toluol, Xylol. Varieties of: see Accra, Angola, Ashanti, Benguela, Benin, Bombay, Borneo, Calcutta, Cameroon, Columbian, Congo, Demerara, East Africa, East Indian, Gaboon Gold Coast, Glass, Kauri, Lindi, Loango, Madagascar, Manilla, Mozambique, Oriental Animé, Pebble, Sierra Leone, South American, Singapore and West African Copals.
- Copper gum-pots, 101, 104.  
— rosinat, 164.
- Copperas, white, 131.
- Cotton-seed oil stearine pitch, 38.
- Cretaceous formation, amber a fossil resin of, 13.
- Cupric acetate, 165.  
— aceto ansenite (emerald green), 164.  
— rosinat, 164.
- D.**
- Dammar aromatique*, 81; *battu*, 81.
- Dammara Alba*, 81; *D. Australis*, 70; *D. Lanceolata*, 76-78; *D. Orientalis*, 82; *D. Ovata*, 77.
- Daniella thurifera*, 70.
- Dead oil, 176.
- Demerara copal, 84-87.
- Dichlorhydrin, 83.
- Dipentene (C<sub>10</sub>H<sub>18</sub>) from Kauri, 73.
- Dipterocarpea, 7.
- Distillation, destructive, of resins: amber, 10; Congo copal, 64; Kauri, 73; Manilla, 74.  
— of coal-tar, 35.  
— of resins for essential oil: copal (= 3 per cent.), 52; Kauri, 73, 75, 78.  
— partial, of resins in varnish-making, 25-29, 96, 109, 113.  
— re-, of amber oil over alkaline solutions, 20.  
— re-, of stearine pitch, 37.
- "Drawing" or "pulling" of varnish, 182.
- Dredging for amber, 14.
- Driers, 6, 130, 160-62.
- Drybalops aromatica*, 18.
- Dry rot preventive, 3.
- Drying properties of varnish, 121.
- Durability of varnish, 121.
- E.**
- East African copal and animé. See Zanzibar Copal.
- Elastic varnishes, 151, 153.
- Elasticity of varnish, 1-5. See Testing of Varnish.
- Electrical insulation, pitch for, 38.
- Electron, 11.
- Elemi, 6, 9.
- Emerald green, 164.
- Enamels, 2.
- English varnish, 8, 177.
- Engraving on glass composition, 40.
- Essential (volatile) oils, 7, 8, 20, 61, 64.
- Epichlorhydrine (C<sub>2</sub>H<sub>5</sub>ClO), (D. = 1.20813 at ° C.; B.P., 116-56° C.), 83.
- Ether acetic. See Acetic Ether.  
— ethylic (C<sub>2</sub>H<sub>5</sub>, O. C<sub>2</sub>H<sub>5</sub>), (D. = 0.736 at ° C.; B.P., 35-5° C.), 20-24, 46, 49-52, 66, 67, 69, 72-75, 78, 81, 84, 86, 87.  
— nitric. See Nitric Ether.

- Ethylic acetate. See Acetic Ether.  
 — alcohol. See Alcohol, Ethylic.  
 — aldehyde. See Aldehyde.  
 — ether. See Ether, Ethylic.  
 — nitrate. See Nitric Ether.

## F.

- Fatty acids in stearine pitch, 36.  
 Felt, black varnishes for roofing, 38, 174.  
*Ficus Elastica L.*, 39.  
 Filtration of varnish, 138-40.  
 Fine paintings, varnish for, 154.  
 First run naphtha, 176.  
 Fixed oils, 45.  
 Flatting varnish, 2.  
 Fluavile, 39.  
 Fractional distillation of resin. See Distillation.  
 — solution of amber, 20-25; copal, 45, 46; Kauri, 73-75; Manilla, 83, 84; Zanzibar animé, 49-54; West Indian animé, 85, 86.  
 Fracture of amber, 15; of copals, 43, 57, 60, 64, 65, 66, 68, 72, 81.  
 "Freezing" of varnish, 182.  
 French polish, 2.  
 Furniture polish, 2.  
 Fusibility of resins. See under Amber and Copal.

## G.

- Gaboon copal, 9, 61, 62, 64, 65.  
 Gamboge, 6.  
 Garbling or grading resins, 56, 88-91.  
 Gas heat, fusing resins by, 27.  
 Gasolene, 129, 130. See Petroleum Ether.  
 Gauging distillate from fused copal to catch right point when soluble in linseed oil, 97, 104.  
*Gedani*, 11.  
 Geographical sources of oil-varnish resins: amber, 11-13; copal, African, East, 47 *et seq.*; African, West, 61 *et seq.*; Kauri, 70; Manilla, 87; West Indian animé, 84-87.  
 German amber earth mines, 13, 14.  
 — East Africa mainland, source of Zanzibar copal, animé, 55.  
 — marine amber exploitations, 14.  
 Gibourtia, 6.  
 Glass coating for engraving, 40.  
 Glessit. See Amber.  
 Gold Coast copal, 68.  
 — size, 157-59.  
 Golden oil varnish, 28.  
 Goose skin, 56.  
 Gum—cleaning, 56, 58, 89; crushing, 89-91; digging. See Kauri; fusing, 25-27, 95-117; garbling and grading, 87-91; in lbs. per gal. of finished varnish,

- 123; melting. See Gum Fusing; roasting, 94; running, 25-27, 95-117; sifting, 88, 89; washing, 56, 58, 89.

## Gum lac, 2.

- Gum-pots, bottle-shaped, 102; cleaning, 104, 159, 172; cast-iron, 101; conical, 102; copper, 103; cylindrical, 101; enamelled, 103; expanded, 102; galvanised, 102; inverted cone, 162; nicked, 102; renewing, 104; repairing, 104; silvered, 102; size of, 104; wrought-iron, 101.  
 Gurjun balsam, 7.  
 Gutta, 39.  
 Gutta-percha, 39.

## H.

- Hancock's rubber varnish, 163.  
 Hard resins, 9.  
 — pitch, 36.  
 Hardness scale, 9, 15, 43.  
 Hemlock spruce, 22.  
 Hopea, 7.  
*Hymenoea*, 10, 47, 87; *H. Courbaril*, 87; *H. Hornemannianum*, 47; *H. Mossambicense*, 47; *H. Verrucosa*, 47, 58, 61.

## I.

- India-rubber, 6, 39.  
 — varnishes, 162, 163.  
 Indian copal, East. See Zanzibar Copal.  
 — — West. See West Indian Animé.  
 Insulation, electrical, pitch for, 38.  
 Iodine value of resins (percentage of iodine absorbed), Manilla, 84.  
 Iron trachylolate, 61.  
 Ironwork, black varnish for, 170-76.  
*Isonandra gutta*, 39.  
 Isoprené from Kauri, 73.

## J.

- Japan, super-black, 172, 173.  
 Japanese wood oil. See vol. i.  
 Japanners' gold size, 157, 158.  
 Japanning, 1.

## K.

- Kauri, 76-80; analysis of, by fractional solution, 72-75; aqueous distillation of, 78; arboriculture (propagation and nursery work) of Kauri trees, 77; essential oil of, 75, 80; fractional solution of, 73, 74; gum digging, 70-72; solubility of, 73-76, 80; varnishes, 152-53.  
 Kaurinic acid, 74, 75.  
 Kaurinolic acid, 74, 75.  
 Kaurolic acid, 74, 75.  
 Kauroresene, 75.  
 Krantzit. See Amber.

## L.

- Lac, 2; lac seed, 28.  
 Lacquer, 2.  
 Laurie's varnish tester, 184, 190.  
 Lavender oil, 46.  
 Lead acetate, 15, 21-24, 50-55. See vol. i.  
 — chromate combustions of resins, 22-24.  
 — driers darken varnish, 120.  
 Leather, artificial. See Pegamoid.  
 Light oil coal-tar, 39.  
 Lindi copal, 44.  
 Linoxin, 118.  
 Litharge, 27, 130. See also vol. i.  
 — boiled oil, 134-54. See also vol. i.  
 Loango copal, 43, 65.  
 Locomotive varnish, 129.  
 Loss in fusing resins, 96.  
 — of turps in mixing varnish, 143.  
 Lustre of varnish, 120.  
 — a factor of index of refraction, 121.

## M.

- Madagascar copal, 9, 10, 42, 47, 56, 57.  
 Manganese borate boiled oil, 134, 154.  
 See also vol. i.  
 Matte varnish, 2.  
 Manilla copal, 5, 6, 9, 43.  
 — — varnishes, 153.  
 Mastic, 9.  
 Mastication test for resins, 65-67.  
 Maturing of linseed oil, 176.  
 — — turps, 129, 162.  
 — — varnish, 127, 128, 160.  
 Medium-hard pitch, 36.  
 — — resin, 9.  
 Melting-points of resins. See Copal.  
 Metals, varnish for, 164.  
 Methoxyl, 57.  
 Methyl alcohol, 60, 67, 72, 87.  
 Methylated spirits, 4, 46.  
 Miller's rubber varnish, 163.  
 Mineral naphtha. See Petroleum Spirit.  
 Mining for amber, 14.  
 Mixing varnish (adding turps), 137, 144.  
 Mozambique copal, 9, 10, 41, 42, 47, 56, 57.  
 Mummy brown, 31.

## N.

- Naphtha coal-tar, 35.  
 — mineral. See Petroleum Spirit.  
 Naphthaline, 36, 60, 61.  
 New Caledonian Kauri, 75-80.  
 New Zealand Kauri, 70-75, 79, 80.  
 Nitration products of trachyloic acid, 52.  
 Nitric ether, 46.  
 — acid, 19.  
 Nitrobenzol, 52.  
 Noxious gases, 182.

## O.

- Ogea gum, 69, 70.  
 Oils, essential, from oil-varnish resins, 20, 61, 64, 75, 80.  
 Oleo-resins, 8.  
 Oriental animé, 41.  
 Oxidation of oleo-resins, 7.  
 — — turps, 8, 9.

## P.

- Packing paper waterproof pitch, 38, 39.  
 Pans, steam-heated, for dissolving fused resins in linseed oil, 145.  
 Paper, varnishes for, 164.  
 — wall, varnish for. See Wallpaper.  
 Paraffin wax, 3, 40.  
 Paraffining casks, 40.  
 Pebble copal, 64, 67, 68.  
 — — varnishes, 152.  
 Pegamoid, 6.  
 Permanganate, action of, on amber and copal oils, 19.  
 Petroleum ether (D. = 0.65-66; B.P., 40-70° C.), 21, 49, 50, 51, 52, 53, 73, 84. See Gasolene.  
 — spirit, 129, 130.  
 Phenol, 36-50.  
 Pinene from Kauri, 73.  
*Pinites succinifer*, 12.  
*Pinus Baltica*, 12; *cembrafolia*, 12; *succinifer*, 12; *succinifera*, 12; *Sylvaticus*, 12.  
*Pissaspalthon*, 30.  
 Pitches: asphaltum, 30; bone, 37; coal-tar, 36; cotton-seed stearine, 38; hard coal-tar, 36; mineral, 30; stearine, 37-39; wool, 37, 38.  
 Pressure, varnish-making under, 148.  
 "Pulling" of varnish, 182.  
 Pyrosuccin, 18, 27-29.  
 — varnishes, 27-29.

## Q.

- Quick-drying manganese boiled oil, 154.  
 — — varnish, 178.  
 — — oak varnish, 153.

## R.

- Ratio of resin to oil in varnish and *vice versa*, 128.  
 — of solvent to other ingredients, resin and oil, in varnish, 181.  
 Raw linseed oil, choice of, 122.  
 — materials, choice of, 122-24; 128-31.  
 Red lead (Pb<sub>2</sub>O<sub>3</sub>) as drier, 130.  
 Refractive index, lustre a factor of, 121.  
 — power of essential oil, 7.  
 Resinates (true), 132-34.  
 Resiniferous trees, acclimatisation of, 48, 57.

- Resinosis, 12, 78.  
 Resins, collection of: amber, 13, 14;  
 animé, 55; West African copal, 62, 63;  
 Kauri, 70, 71, 76, 77, 78.  
 — function of, in varnish, 5; hardness,  
 9; properties, 8. See under Amber  
 Copal and its varieties.  
 Rock salt, scratch test for resins, 15.  
 Roofing felt, pitch for, 88.  
 Roots, secretion of resin by, 54, 76.  
 Rosemary oil, 46.  
 Rosin, 9, 167.  
 — hardened, 164.  
 — pitch useless for varnish. See vol.  
 iii.  
 — varnishes, 164-67.  
 Rosinates, 131-32.  
 — coloured, 164.  
 Rumanit, 11.
- S.**
- Saffron (dye for varnish), 28.  
 Salicylic acid, 57; in antifouling com-  
 position, 164.  
 Sandarac, 9.  
*Sandarusi*, 47; *niti*, 47.  
 Saponification value (milligrammes of  
 KHO to completely saponify 1  
 gramme of resin. See vol. i., method  
 for resins similar to that for oils) of  
 amber (resin acids of), 21-25; Accra  
 copal, 68; Brazil copal, 87; Cameroon  
 copal, 68; Columbian copal, 87; Kauri,  
 resin acids of, 74; pebble copal, 68;  
 Zanzibar resins, acids of, 49-54.  
 Saturated hydrocarbides of paraffin  
 ( $C_nH_{2n+2}$ ), 40.  
 Secreting vessels of resiniferous pines  
 (succinosis resinosis) of amber, 12;  
 of New Caledonian Kauri, 78.  
 Set-pot, 113, 116.  
*Shajar-el-sandarus*, 47.  
 Shellac, 28.  
 Shorea, 7.  
 Siberian fir resinosis, 12.  
 Sicilian amber, 13.  
 Sierra Leone copal, 9, 42, 43-47, 61, 62,  
 63-66; varnishes, 153.  
 Simeitit, 11.  
 Singapore copal, 9.  
 Sodium nitroprusside reaction for sul-  
 phur in amber, 21.  
 — thiosulphate, 19.  
 Soft pitch, 84-86.  
 Solubility of resins. See under Amber  
 and Copal.  
 Solvents. See under Copal.  
 South American copal, 9, 84-87.  
 Spirits of turpentine ( $C_{10}H_{16}$ ), (D. = 0.866;  
 B.P., 158° C.; F.P., 96° F.), 20, 25, 26,  
 28, 29, 40, 45, 46, 66, 69, 78, 81, 96,  
 107, 111, 117, 119, 124, 126, 127, 128,  
 129, 132, 133, 134, 135, 136, 137, 138,  
 142, 143, 144, 145, 147, 148, 149, 150,  
 151, 152, 153, 154, 155, 156, 157, 158,  
 159, 161, 162, 163, 164, 165, 166, 167,  
 168, 169, 170, 171, 172, 173, 188, 184,  
 186.  
 Spirits of turpentine, camphoretted, 46.  
 — methylated (F.P., 62° F.), 46.  
 — wood. See Methyl Alcohol.  
 Stand oil (thickened linseed oil), 153.  
 Stearine pitch, 37-39.  
 Still, jacketed, 17-20; for fractional dis-  
 tillation of coal-tar, 35.  
 Stills or retorts for fusing amber or copal  
 with condensers for fumes: amber,  
 25-27; copal, 109, 110, 111, 112, 113.  
 Stringing test in boiling varnish, 132.  
 "Stringing" of Manila, 5.  
 Succin, 1.  
 Succinic acid, 18, 19, 21-25.  
 Succinin, 24, 25.  
 Succinit. See Amber.  
 Succino-abietinic acid, 21-25.  
 — — — ester, 21-25.  
 — abietol, 22-24.  
 — resinol, 24.  
 — sylvinic acid, 24.  
 Sulphur in amber and amber oil, 15,  
 19, 21, 24.  
 — test for amber, 15.  
 Swiss amber, 13.
- T.**
- Tar-coal, 34-36.  
 — — still, 35.  
 — — varnishes, 173-76.  
 Tarpaulins, 38.  
 Terpenes from Kauri, 73.  
 Terpineol acetate, 46.  
 Testing varnish, 183-92.  
 — — Laurie's tester, 184-90.  
 — — Jahns' tester, 190-92.  
 Thus, gum, 6.  
 Tingry's varnish-making plant, 104-7.  
 Toluol (toluene) ( $C_6H_5CH_3$ ), (D. = 0.882 at  
 °C.; B.P., 111° C.), 49, 50, 52, 53, 73,  
 84.  
*Trachylobium Hornemannianum*, 47.  
 Turpentine, spirits of. See Spirits of  
 Turpentine.  
 — substitutes, 129, 130.  
 — Venice, 6, 176.
- U.**
- Ultimate composition of resenes and  
 resin acids of amber, 20-25; copal  
 (Kauri), 72-75; (Manilla), 83, 84;  
 (Zanzibar), 49-54.  
 Umber, 131.  
 Utilisation of waste varnish products.  
 See Residuals.

## V.

Varnish, aging of, 159, 160; ammonia, effects of on, 182; application of, 182; blistering of, 182; blooming of, 182; brilliancy of, 178; chilling of, 182; colour of, 120, 178; compounding (irrational) of, bad results, 181; consistency of, 178; constituents of, 110; damaged by sea water, 184; decorative effect of, 1-4; determination of oil resin and volatile solvent in, 183, 184; driers for, 130-34 (see also vol. i.); drying of, 121, 178; durability of, 121; elasticity of, 1-5, 180, 181; faults in, 160-62, 181; filtration of, 188, 139; flexibility of, 3, 180; hardness of, 9, 134; index of refraction of, 121; lustre of, 3, 121; maturing of, 159, 160; moisture, mixing of, effects of, on, 182; noxious gases, action of, on, 182; oil, determination of, in, 183, 184; oil, ratio of resin to, in, 128, 158; pinholing of, 161; quick drying of, 178; ratio of resin to oil, 128, 158; ratio of resin to finished varnish, 128, 158; resin, determination of, in rosinate varnish, 164; storing of, 127; testing of, 177-192; transparency, 3, 180; wrinkling, 197.

Varnishes from amber, 27-29; East African copal animé, 151, 152; Kauri, 152, 153; Manilla, 153; West African, 152.

— for special purposes (arranged mostly in accordance with trade name): artists' virgin copal, 154; best body copal, 154; best coating body, 153; best pale carriage, 156; black (blue black), 169-76; black japan, 172, 173; black ship's, 175, 176; Brunswick black, 173; cabinet, 155; carriage, 151; coach, 29; coach iron-work, 173; common body, 156; common oak, 153; confectionery box, 167; cycle, 171; elastic, 151; elastic carriage, 153; enamel, 154; extra superfine coach, 154; final coat, 29; fine artists', 154; fine carriage, 154; fine coach, 154; fine paintings, 154; fine railway carriage, 154; finishing body,

153; flattening, 2, 153; flock gold size, 156; floor, 29, 154; furniture, 29, 154; gilt cabinet, 154; glass, 164; golden oil, 28; gold size, 156; green, 165; hard church, 153; high temperature, 175; imperial black varnish, 175, 176; indoor, 151; japan black, 172, 173; japanners' gold size, 156; leather, 164; linoleum, 164; mahogany, 156; marble, 154; metal, 164; microscopic mounting of slides, 86; mixing, 153; oak, 153; outdoor, 151; pale amber, 28; pale French flattening, 153; paper, 164; plaster casts, 167; polishing, 154; quick-drying body, 156; quick oak, 153; quick carriage, 153; sewing machine, 171; ship bottom, 164; sledge, 154; snuff-box, 167; sugar mould, 154; super-black japan, 154; superfine artists', 154; superfine carriage, 154; superfine coach, 154; superfine copal indoor, 154; superfine copal outdoor, 154; superfine locomotive, 154; superfine marble, 154; table, 29; table top, 154; tin boxes, 164, 165; tinware, 29; toys, 164; wainscot, 157; wallpaper, 167; waterproof, 174; wood, 164.

## W.

Waste products. See Residuals.

White copperas, 156, 157, 161, 162.

Wood, grain of, varnishes enhance beauty of, 3.

## X.

Xylol (Xylene), 86.

## Y.

Young Zanzibar copal, 47-54.

— Sierra Leone, 61.

— Kauri, 77.

## Z.

Zanzibar copal, 47 *et seq.*

Zinc chloride, 19.

— sulphate. See White Copperas.

# J. F. FARWIG & CO.,

## OIL AND VARNISH CAN MANUFACTURERS,



**Contractors to the  
Admiralty, War  
and India Offices.**

**Patent Capsules and Machines  
for Hermetically Sealing  
Cans holding  
Enamels, Varnish, Oils, etc.,  
without the use of Corks.**

**Tin Capsule.  
Tin Bung.**



**These Cans are specially made for  
the safe carriage of Petrol, and  
have been tested and passed at  
the Railway Clearing House.  
Guaranteed tested up to 5 lbs. per  
square inch.**

**Patent Peel-off  
Tins  
and Machines  
for  
Hermetically  
Sealing.**

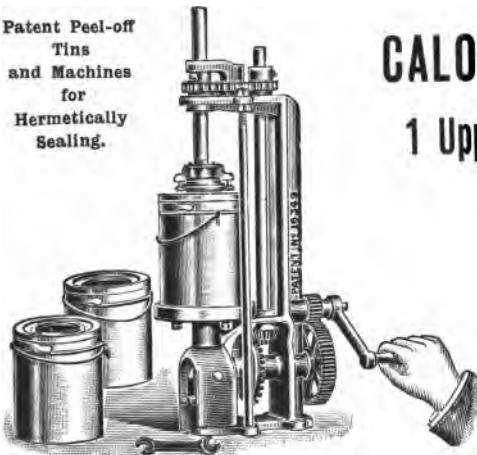

**SPECIALITIES :-**

**TINS and CANS for PETROLEUM  
and MOTOR SPIRIT.**

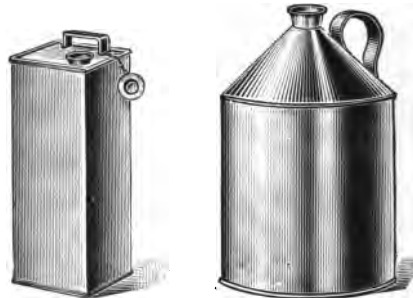

**CALORIGEN WORKS,  
1 Upper Thames Street,  
LONDON, E.C.**

**ESTABLISHED 1809.**

**Telegraphic Address:  
"CALORIGEN, LONDON".**

**Telephone No. : 732 BANK.**

Established 1888.

Branch Works { Rawcliffe Bridge,  
Yorkshire.

# **RESINATES**

of Aluminium, Calcium (Lime), Copper,

**LEAD, Magnesium, MANGANESE and Zinc**

— PRECIPITATED AND FUSED. —

# **LINOLEATES,**

Lump Terebines,

**HARDENED RESINS and**

# **GUM SUBSTITUTES.**

MANUFACTURED BY

**GRINDLEY & Co., Ltd.,**

Specialists in Soluble Drier Preparations,

**POPLAR, LONDON, E.**

Telegrams—

“RESINOUS, LONDON,” and  
“GRINDLEY, RAWCLIFFE BRIDGE, YORKSHIRE”.

Telephone Nos.—

EAST 58,  
and EAST 1578.

UNIFORM WITH THIS VOLUME:—

**OIL CRUSHING, REFINING AND BOILING, THE MANUFACTURE OF LIOLEUM, PRINTING AND LITHOGRAPHIC INKS, AND INDIA-RUBBER SUBSTITUTES.** By JOHN GEDDES McINTOSH. Being Volume I. of the Second, greatly enlarged, English Edition, in three Volumes, of "The Manufacture of Varnishes and Kindred Industries," based on and including the work of ACH. LIVACHE. Demy 8vo. 150 pages. 29 Illus.

CONTENTS.—Oil Crushing and Refining; Oil Boiling—Theoretical and Practical; Linoleum Manufacture; Printing Ink Manufacture; Rubber Substitutes; The Manufacture of Driers; The Detection of Adulteration in Linseed and other Drying Oils by Chemical, Physical and Organoleptic Methods.

Price 7s. 6d. net (Post Free, 7s. 10d. Home; 8s. Abroad).

**DRYING OILS, BOILED OIL, AND SOLID AND LIQUID DRIERS.** A Practical Work for Manufacturers of Oils, Varnishes, Printing Inks, Oil-Cloth and Linoleum, Oil-Cakes, Paints, etc. By LOUIS EDGAR ANDÉS, Author of "Animal Fats and Oils," "Vegetable Fats and Oils," "Iron Corrosion, Anti-Fouling and Anti-Corrosive Paints," etc. 42 Illustrations. 342 pages. Demy 8vo.

CONTENTS.—General Chemical and Physical Properties of the Drying Oils—The Properties of and Methods for Obtaining the Drying Oils—Production of the Drying Oils by Expression and Extraction—The Manufacture of Boiled Oil—The Preparation of Drying Oils for Use in the Grinding of Paints—The Preparation of Varnishes for Letterpress, Lithographic and Copperplate Printing; for Oil-cloth and Waterproof Fabrics—Behaviour of the Drying Oils and Boiled Oils towards Atmospheric Influences, Water, Acids and Alkalies—Boiled Oil Substitutes—The Manufacture of Solid and Liquid Driers—The Adulteration and Examination of the Drying Oils and Boiled Oil; Index of Names. Subject-Matter Index.

Price 12s. 6d. net (Post Free, 13s. Home; 13s. 3d. Abroad).

**ANALYSIS OF RESINS, BALSAMS AND GUM-RESINS.** Their Chemistry and Pharmacognosis. Translated from the German of Dr. KARL DIETERICH. Demy 8vo. 340 pages.

Price 7s. 6d. net (Post Free, 7s. 10d. Home; 8s. 3d. Abroad).

**THE MANUFACTURE OF PAINT.** A Practical Handbook for Paint Manufacturers, Merchants and Students. By J. CRUICKSHANK SMITH, B.Sc. Demy 8vo. 200 pp. 60 Illustrations and 1 Large Diagram, showing arrangement of Modern Paint Manufactory.

"Will fill a place hitherto unoccupied; . . . bears all the marks of thoroughness both on the scientific and technical side. That it will take its place as the standard book of its subject may safely be predicted."—*Aberdeen Free Press*.

"This is a workmanlike manual of the methods and processes of an industry known to the world at large only by its remote results. . . . This clearly written and well-informed handbook gives a plain exposition of these matters, and cannot but prove useful to manufacturers and merchants, and to painters curious about the materials in which they work."—*The Scotsman*.

"For a young man serving his apprenticeship in paint-making, whatever his position may be, no more serviceable handbook could be recommended, and many of more lengthened experience will find it a not unprofitable investment."—*Glasgow Herald*.

"Mr. Smith's book is practical throughout, and it will be found helpful to those engaged in the industry and those who make use of paints."—*The Architect*.

"It is an important text-book for students attending technical classes in these subjects, concisely setting forth in a most practical manner many intricate details in the preparation and production of paint during the operation of grinding. . . . The work should occupy a position on the bookshelf of every individual interested in paint."—*The Decorators' and Painters' Magazine*.

Price 7s. 6d. net (Post Free, 7s. 10d. Home; 8s. Abroad).

**SIMPLE METHODS FOR TESTING RAW MATERIALS.** By A. C. WRIGHT, M.A. (Oxon.), B.Sc. (Lond.). Crown 8vo. 160 pages.

Price 5s. net (Post Free, 5s. 3d. Home; 5s. 6d. Abroad).

Published by **SCOTT, GREENWOOD & SON,**  
8 BROADWAY, LUDGATE HILL, LONDON, E.C.



# Abridged Catalogue

OF

## Special Technical Books.

### INDEX TO SUBJECTS.

|                                       | PAGE   |                                | PAGE        |  | PAGE       |
|---------------------------------------|--------|--------------------------------|-------------|--|------------|
| Adhesives ... ..                      | 10     | Engineering Handbooks ...      | 19, 20      | Power-loom Weaving ...                 | 14         |
| Agricultural Chemistry ...            | 9      | Engraving ... ..               | 24          | Preserved Foods ... ..                 | 28         |
| Air, Industrial Use of ...            | 10     | Essential Oils ... ..          | 7           | Printers' Ready Reckoner               | 24         |
| Alcohol, Industrial ... ..            | 9      | Evaporating Apparatus ...      | 18          | Printing Inks ... ..                   | 3, 4, 5    |
| Alum and its Sulphates ...            | 8      | External Plumbing ... ..       | 21          | Recipes ... ..                         | 3, 18      |
| Ammonia ... ..                        | 8      | Fats ... ..                    | 6           | Resins ... ..                          | 9          |
| Aniline Colours ... ..                | 3      | Faults in Woollen Goods        | 15          | Ring Spinning Frame ...                | 17         |
| Animal Fats ... ..                    | 6      | Flax Spinning ... ..           | 17          | Risks of Occupations ...               | 10         |
| Anti-corrosive Paints ...             | 4      | Food and Drugs ... ..          | 23          | Riveting China, etc. ...               | 12         |
| Architecture, Terms in ...            | 22     | Fruit Preserving ... ..        | 23          | Scheele's Essays ... ..                | 8          |
| Architectural Pottery ...             | 12     | Gas Firing ... ..              | 18          | Sealing Waxes ... ..                   | 10         |
| Artificial Perfumes ... ..            | 7      | Glass-making Recipes ...       | 13          | Shale Oils and Tars ...                | 9          |
| Balsams ... ..                        | 9      | Glass Painting ... ..          | 13          | Sheet Metal Working ...                | 21         |
| Bleaching Agents, etc. ...            | 17     | Glue-making and Testing...     | 8           | Shoe Polishes ... ..                   | 6          |
| Bone Products ... ..                  | 8      | Glycerine ... ..               | 7           | Silk Dyeing ... ..                     | 16         |
| Bookbinding ... ..                    | 24     | Greases ... ..                 | 6           | Silk Throwing, etc. ...                | 17         |
| Brick-making ... ..                   | 11, 12 | Gutta Percha ... ..            | 11          | Smoke Prevention... ..                 | 18         |
| Burnishing Brass ... ..               | 21     | Hat Manufacturing ... ..       | 15          | Soap Powders ... ..                    | 7          |
| Carpet Yarn Printing ... ..           | 16     | Hemp Spinning ... ..           | 17          | Soaps... ..                            | 7          |
| Casein ... ..                         | 4      | History of Staffs Potteries    | 12          | Spinning ... ..                        | 15, 17     |
| Celluloid ... ..                      | 23     | Hops ... ..                    | 22          | Spirit Varnishes ... ..                | 5          |
| Cement ... ..                         | 22     | Hot-water Supply ... ..        | 21          | Staining Marble, and Bone              | 28         |
| Ceramic Books ... ..                  | 11, 12 | India-rubber... ..             | 11          | Stain-removing Soaps ...               | 7          |
| Charcoal ... ..                       | 8      | India-rubber Substitutes       | 5           | Standard Cloths ... ..                 | 13         |
| Chemical Analysis... ..               | 8      | Inks ... ..                    | 3, 4, 5, 10 | Steam Drying ... ..                    | 10         |
| Chemical Essays ... ..                | 8      | Insecticides, etc. ... ..      | 22          | Steel Hardening ... ..                 | 10         |
| Chemical Reagents ... ..              | 8      | Iron-corrosion ... ..          | 4           | Sugar Technology ... ..                | 24         |
| Chemical Works ... ..                 | 8      | Iron, Science of ... ..        | 18          | Sweetmeats... ..                       | 28         |
| Church Lace ... ..                    | 14     | Japanning ... ..               | 21          | Tallow ... ..                          | 6          |
| Clays ... ..                          | 12     | Jute Spinning ... ..           | 17          | Technical Schools, List ...            | 24         |
| Coal-Dust Firing ... ..               | 18     | Lace-Making ... ..             | 14          | Terra-cotta ... ..                     | 32         |
| Coal Gas By-Products ...              | 9      | Lacquering ... ..              | 21          | Testing Paint Materials ...            | 4          |
| Colliery Recovery Work... ..          | 18     | Lake Pigments ... ..           | 3           | Textile Colour Mixing ...              | 16         |
| Colour Matching (Textile)             | 16     | Lead ... ..                    | 10          | Textile Design ... ..                  | 14         |
| Colour Recipes ... ..                 | 3      | Leather-working Materials      | 6, 11       | Textile Fabrics ... ..                 | 13, 14, 15 |
| Colour Theory ... ..                  | 16     | Linoleum ... ..                | 5           | Textile Fibres ... ..                  | 14         |
| Combing Machines ... ..               | 17     | Lithographic Inks ... ..       | 5, 23       | Textile Materials ... ..               | 14         |
| Compounding Oils, etc. ...            | 6      | Lithography ... ..             | 23          | Timber ... ..                          | 22         |
| Condensing Apparatus ...              | 18     | Lubricants ... ..              | 6           | Toilet Soapmaking ... ..               | 7          |
| Cosmetics ... ..                      | 7      | Manures ... ..                 | 8, 9        | Varnishes ... ..                       | 5          |
| Cotton Dyeing ... ..                  | 16     | Meat Preserving ... ..         | 23          | Vegetable Fats and Oils ...            | 6          |
| Cotton Spinning ... ..                | 17     | Medicated Soaps ... ..         | 7           | Vegetable Preserving ...               | 23         |
| Cotton Waste ... ..                   | 15     | Metal Polishing Soaps ...      | 7           | Warp Sizing ... ..                     | 15         |
| Damask Weaving ... ..                 | 17     | Mineral Pigments ... ..        | 3           | Waste Utilisation ... ..               | 9          |
| Dampness in Buildings ...             | 22     | Mineral Waxes ... ..           | 6           | Water, Industrial Use ...              | 10, 11     |
| Decorators' Books ... ..              | 4      | Mine Ventilation ... ..        | 18          | Water-proofing Fabrics ...             | 15         |
| Decorative Textiles ... ..            | 15     | Mining, Electricity ... ..     | 18          | Waxes ... ..                           | 6          |
| Dental Metallurgy... ..               | 18     | Needlework ... ..              | 14          | Weaving Calculations ...               | 15         |
| Disinfection ... ..                   | 9      | Oil and Colour Recipes ...     | 3           | White Lead and Zinc White              | 5          |
| Driers ... ..                         | 5      | Oil Boiling ... ..             | 5           | Wiring Calculations ...                | 21         |
| Drugs ... ..                          | 23     | Oil Merchants' Manual ...      | 6           | Wood Distillation ... ..               | 22         |
| Drying Oils ... ..                    | 5      | Oils ... ..                    | 5, 6, 7     | Wood Extracts ... ..                   | 22         |
| Drying with Air, etc. ...             | 10     | Ozone, Industrial Use of... .. | 10          | Wood Waste Utilisation... ..           | 22         |
| Dyeing Marble, etc. ... ..            | 23     | Paint Manufacture ... ..       | 3           | Wood-Dyeing ... ..                     | 28         |
| Dyeing Fabrics ... ..                 | 16     | Paint Materials ... ..         | 3           | Wool Dyeing ... ..                     | 16         |
| Dyers' Materials ... ..               | 16     | Paint-material Testing ...     | 4           | Woollen Goods ... ..                   | 15, 16     |
| Dye-stuffs ... ..                     | 16     | Paint Mixing ... ..            | 3, 4        | Worsted Spinning ... ..                | 15         |
| Edible Fats and Oils ... ..           | 6      | Paper-Mill Chemistry ...       | 13          | Woven Fabrics ... ..                   | 15         |
| Electric Lamp Develop-<br>ment ... .. | 21     | Pigments ... ..                | 3, 9        | Writing Inks ... ..                    | 10         |
| Electric Wiring ... ..                | 21     | Plumbers' Books ... ..         | 21          | X-Ray Work ... ..                      | 11         |
| Electricity in Collieries ...         | 18     | Pottery Clays ... ..           | 12          | Yarn Sizing ... ..                     | 15         |
| Emery ... ..                          | 24     | Pottery Decorating ... ..      | 11, 11      | Yarn Numbering and Test-<br>ing ... .. | 14, 15     |
| Enamelling Metal ... ..               | 13     | Pottery Manufacture ... ..     | 11, 12      | Zinc White Paints ... ..               | 5          |
| Enamels ... ..                        | 13     | Pottery Marks ... ..           | 12          |  |            |

PUBLISHED BY

SCOTT, GREENWOOD & SON.

8 BROADWAY, LUDGATE, LONDON, E.C. (ENGLAND).

# FULL PARTICULARS OF CONTENTS

Of the Books mentioned in this ABRIDGED CATALOGUE  
will be found in the following Catalogues of

## CURRENT TECHNICAL BOOKS.

---

### LIST I.

Artists' Colours—Bone Products—Butter and Margarine Manufacture—Casein—Cements—Chemical Works (Designing and Erection)—Chemistry (Agricultural, Industrial, Practical and Theoretical)—Colour Mixing—Colour Manufacture—Compounding Oils—Decorating—Driers—Drying Oils—Drysaltery—Emery—Essential Oils—Fats (Animal, Vegetable, Edible)—Gelatines—Glues—Greases—Gums—Inks—Lead—Leather—Lubricants—Oils—Oil Crushing—Paints—Paint Manufacturing—Paint Material Testing—Perfumes—Petroleum—Pharmacy—Recipes (Paint, Oil and Colour)—Resins—Sealing Waxes—Shoe Polishes—Soap Manufacture—Solvents—Spirit Varnishes—Varnishes—White Lead—Workshop Wrinkles.

### LIST II.

Bleaching—Bookbinding—Carpet Yarn Printing—Colour (Matching, Mixing Theory)—Cotton Combing Machines—Dyeing (Cotton, Woollen and Silk Goods)—Dyers' Materials—Dye-stuffs—Engraving—Flax, Hemp and Jute Spinning and Twisting—Gutta-Percha—Hat Manufacturing—India-rubber—Inks—Lace-making—Lithography—Needlework—Paper Making—Paper-Mill Chemist—Paper-pulp Dyeing—Point Lace—Power-loom Weaving—Printing Inks—Silk Throwing—Smoke Prevention—Soaps—Spinning—Textile (Spinning, Designing, Dyeing, Weaving, Finishing)—Textile Materials—Textile Fabrics—Textile Fibres—Textile Oils—Textile Soaps—Timber—Water (Industrial Uses)—Water-proofing—Weaving—Writing Inks—Yarns (Testing, Sizing).

### LIST III.

Architectural Terms—Brassware (Bronzing, Burnishing, Dipping, Lacquering)—Brickmaking—Building—Cement Work—Ceramic Industries—China—Coal-dust Firing—Colliery Books—Concrete—Condensing Apparatus—Dental Metallurgy—Drainage—Drugs—Dyeing—Earthenware—Electrical Books—Enamelling—Enamels—Engineering Handbooks—Evaporating Apparatus—Flint Glass-making—Foods—Food Preserving—Fruit Preserving—Gas Engines—Gas Firing—Gearing—Glassware (Painting, Riveting)—Hops—Iron (Construction, Science)—Japanning—Lead—Meat Preserving—Mines (Haulage, Electrical Equipment, Ventilation, Recovery Work from)—Plants (Diseases, Fungicides, Insecticides)—Plumbing Books—Pottery (Architectural. Cl. ys Decorating, Manufacture, Marks on)—Reinforced Concrete—Riveting (China, Earthenware, Glassware)—Sanitary Engineering—Steam/Turbines—Steel (Hardening, Tempering)—Sugar—Sweetmeats—Toothed Gearing—Vegetable Preserving—Wood Dyeing—X-Ray Work.

---

COPIES OF ANY OF THESE LISTS WILL BE SENT  
POST FREE ON APPLICATION.

FOR A CATALOGUE LISTED ABOVE

PLEASE REFER TO THE LISTED ABOVE, IN THE ABOVE

## (Paints, Colours, Pigments and Printing Inks.)

**THE CHEMISTRY OF PIGMENTS.** By ERNEST J. PARRY, B.Sc. (Lond.), F.I.C., F.C.S., and J. H. COSTE, F.I.C., F.C.S. Demy 8vo. Five Illustrations. 285 pp. Price 10s. 6d. net. (Post free, 11s. home; 11s. 2d. abroad.)

**THE MANUFACTURE OF PAINT.** A Practical Handbook for Paint Manufacturers, Merchants and Painters. By J. CRUICKSHANK SMITH, B.Sc. Second Edition, Revised and Enlarged. Demy 8vo. 288 pp. 80 Illustrations. Price 10s. 6d. net. (Post free, 11s. home; 11s. 2d. abroad.)

**DICTIONARY OF CHEMICALS AND RAW PRODUCTS USED IN THE MANUFACTURE OF PAINTS, COLOURS, VARNISHES AND ALLIED PREPARATIONS.** By GEORGE H. HURST, F.C.S. Demy 8vo. [*New Revised Edition in the Press.*]

**THE MANUFACTURE OF LAKE PIGMENTS FROM ARTIFICIAL COLOURS.** By FRANCIS H. JENNISON, F.I.C., F.C.S. **Sixteen Coloured Plates, showing Specimens of Eighty-nine Colours, specially prepared from the Recipes given in the Book.** 136 pp. Demy 8vo. Price 7s. 6d. net. (Post free, 8s. home; 8s. 2d. abroad.)

**THE MANUFACTURE OF MINERAL AND LAKE PIGMENTS.** Containing Directions for the Manufacture of all Artificial, Artists and Painters' Colours, Enamel, Soot and Metallic Pigments. A text-book for Manufacturers, Merchants, Artists and Painters. By Dr. JOSEF BERSCH. Translated by A. C. WRIGHT, M.A. (Oxon.), B.Sc. (Lond.). Forty-three Illustrations. 476 pp. Demy 8vo. Price 12s. 6d. net. (Post free, 13s. home; 13s. 6d. abroad.)

**RECIPES FOR THE COLOUR, PAINT, VARNISH, OIL, SOAP AND DRYSALTERY TRADES.** Compiled by AN ANALYTICAL CHEMIST. 330 pp. Second Revised and Enlarged Edition. Demy 8vo. Price 10s. 6d. net. (Post free, 11s. home; 11s. 2d. abroad.)

**OIL COLOURS AND PRINTERS' INKS.** By LOUIS EDGAR ANDÉS. Translated from the German. 215 pp. Crown 8vo. 56 Illustrations. Price 5s. net. (Post free, 5s. 4d. home and abroad.)

**MODERN PRINTING INKS.** A Practical Handbook for Printing Ink Manufacturers and Printers. By ALFRED SEYMOUR. Demy 8vo. Six Illustrations. 90 pages. Price 5s. net. (Post free, 5s. 4d. home and abroad.)

**THREE HUNDRED SHADES AND HOW TO MIX THEM.** For Architects, Painters and Decorators. By A. DESAINT, Artistic Interior Decorator of Paris. The book contains 100 folio Plates, measuring 12 in. by 7 in., each Plate containing specimens of three artistic shades. These shades are all numbered, and their composition and particulars for mixing are fully given at the beginning of the book. Each Plate is interleaved with grease-proof paper, and the volume is very artistically bound in art and linen with the Shield of the Painters' Guild impressed on the cover in gold and silver. Price 21s. net. (Post free, 21s. 7d. home; 22s. 2d. abroad.)

**HOUSE DECORATING AND PAINTING.** By W. NORMAN BROWN. Eighty-eight Illustrations. 150 pp. Crown 8vo. Price 3s. 6d. net. (Post free, 3s. 10d. home and abroad.)

**A HISTORY OF DECORATIVE ART.** By W. NORMAN BROWN. Thirty-nine Illustrations. 96 pp. Crown 8vo. Price 1s. net. (Post free, 1s. 4d. home and abroad.)

**WORKSHOP WRINKLES** for Decorators, Painters, Paperhangers, and Others. By W. N. BROWN. Crown 8vo. 128 pp. Second Edition. Price 2s. 6d. net. (Post free, 2s. 10d. home and abroad.)

**CASEIN.** By ROBERT SCHERER. Translated from the German by CHAS. SALTER. Demy 8vo. Illustrated. Second Revised English Edition. 160 pp. Price 7s. 6d. net. (Post free, 8s. home and abroad.)

**SIMPLE METHODS FOR TESTING PAINTERS' MATERIALS.** By A. C. WRIGHT, M.A. (Oxon.), B.Sc. (Lond.). Crown 8vo. 160 pp. Price 5s. net. (Post free, 5s. 4d. home and abroad.)

**IRON-CORROSION, ANTI-FOULING AND ANTI-CORROSIVE PAINTS.** Translated from the German of LOUIS EDGAR ANDÉS. Sixty-two Illustrations. 275 pp. Demy 8vo. Price 10s. 6d. net. (Post free, 11s. home and abroad.)

**THE TESTING AND VALUATION OF RAW MATERIALS USED IN PAINT AND COLOUR MANUFACTURE.** By M. W. JONES, F.C.S. A Book for the Laboratories of Colour Works. 88 pp. Crown 8vo. Price 5s. net. (Post free, 5s. 4d. home and abroad.)

---

*For contents of these books, see List I.*

**THE MANUFACTURE AND COMPARATIVE MERITS OF WHITE LEAD AND ZINC WHITE PAINTS.** By G. PETIT, Civil Engineer, etc. Translated from the French. Crown 8vo. 100 pp. Price 4s. net. (Post free, 4s. 4d. home and abroad.)

**STUDENTS' HANDBOOK OF PAINTS, COLOURS, OILS AND VARNISHES.** By JOHN FURNELL. Crown 8vo. 12 Illustrations. 96 pp. Price 2s. 6d. net. (Post free, 2s. 10d. home and abroad.)

**PREPARATION AND USES OF WHITE ZINC PAINTS.** Translated from the French of P. FLEURY. Crown 8vo. 280 pages. Price 6s. net. (Post free, 6s. 5d. home; 6s. 6d. abroad.)

(Varnishes and Drying Oils.)

**THE MANUFACTURE OF VARNISHES AND KINDRED INDUSTRIES.** By J. GEDDES McINTOSH. Second, greatly enlarged, English Edition, in three Volumes. based on and including the work of Ach. Livache.

**VOLUME I.—OIL CRUSHING, REFINING AND BOILING, THE MANUFACTURE OF LINO-LEUM, PRINTING AND LITHOGRAPHIC INKS, AND INDIA-RUBBER SUBSTITUTES.** Demy 8vo. 150 pp. 29 Illustrations. Price 7s. 6d. net. (Post free, 7s. 10d. home and abroad.)

**VOLUME II.—VARNISH MATERIALS AND OIL-VARNISH MAKING.** Demy 8vo. 70 Illustrations. 220 pp. Price 10s. 6d. net. (Post free, 11s. home and abroad.)

**VOLUME III.—SPIRIT VARNISHES AND SPIRIT VARNISH MATERIALS.** Demy 8vo. Illustrated. 464 pp. Price 12s. 6d. net. (Post free, 13s. home; 13s. 2d. abroad.)

**DRYING OILS, BOILED OIL AND SOLID AND LIQUID DRIERS.** By L. E. ANDÉS. Expressly Written for this Series of Special Technical Books, and the Publishers hold the Copyright for English and Foreign Editions. Second Revised Edition. Forty-three Illustrations. 352 pp. Demy 8vo. Price 12s. 6d. net. (Post free, 13s. home; 13s. 2d. abroad.)

(*Analysis of Resins, see page 9.*)

## (Oils, Fats, Waxes, Greases, Petroleum.)

### **LUBRICATING OILS, FATS AND GREASES :**

Their Origin, Preparation, Properties, Uses and Analyses. A Handbook for Oil Manufacturers, Refiners and Merchants, and the Oil and Fat Industry in General. By GEORGE H. HURST, F.C.S. Third Revised and Enlarged Edition. Seventy-four Illustrations. 384 pp. Demy 8vo. Price 10s. 6d. net. (Post free, 11s. home; 11s. 2d. abroad.)

### **MINERAL WAXES :** Their Preparation and Uses. By

RUDOLF GREGORIUS. Translated from the German. Crown 8vo. 250 pp. 32 Illustrations. Price 6s. net. (Post free, 6s. 5d. home; 6s. 6d. abroad.)

### **THE PRACTICAL COMPOUNDING OF OILS, TALLOW AND GREASE FOR LUBRICATION, ETC.**

By An EXPERT OIL REFINER. Second Edition. Demy 8vo. 100 pp. Price 7s. 6d. net. (Post free, 7s. 10d. home; 8s. abroad.)

### **THE MANUFACTURE OF LUBRICANTS, SHOE POLISHES AND LEATHER DRESSINGS.**

By RICHARD BRUNNER. Translated from the Sixth German Edition. Second English Edition. Crown 8vo. 188 pp. 10 Illustrations. Price 7s. 6d. net. (Post free, 8s. home and abroad.)

### **THE OIL MERCHANTS' MANUAL AND OIL TRADE READY RECKONER.**

Compiled by FRANK F. SHERRIFF. Second Edition Revised and Enlarged. Demy 8vo. 214 pp. With Two Sheets of Tables. Price 7s. 6d. net. (Post free, 8s. home; 8s. 2d. abroad.)

### **ANIMAL FATS AND OILS :** Their Practical Pro-

duction, Purification and Uses for a great Variety of Purposes. Their Properties, Falsification and Examination. Translated from the German of LOUIS EDGAR ANDÉS. Sixty-two Illustrations. 240 pp. Second Edition, Revised and Enlarged. Demy 8vo. Price 10s. 6d. net. (Post free, 11s. home and abroad.)

### **VEGETABLE FATS AND OILS :** Their Practical

Preparation, Purification and Employment for Various Purposes, their Properties, Adulteration and Examination. Translated from the German of LOUIS EDGAR ANDÉS. Ninety-four Illustrations. 340 pp. Second Edition. Demy 8vo. Price 10s. 6d. net. (Post free, 11s. home; 11s. 2d. abroad.)

### **EDIBLE FATS AND OILS :** Their Composition, Manu-

facture and Analysis. By W. H. SIMMONS, B.Sc. (Lond.), and C. A. MITCHELL, B.A. (Oxon.). Demy 8vo. 150 pp. Price 7s. 6d. net. (Post free, 7s. 10d. home and abroad.)

---

*For contents of these books, see List I.*

**(Glycerine.)**

**GLYCERINE:** Its Production, Uses, and Examination.  
By S. W. KOPPE. Translated from the Second German Edition.  
260 pp. 7 Illustrations. Crown 8vo. Price 7s. 6d. net. (Post  
free, 8s. home and abroad.)

**(Essential Oils and Perfumes.)**

**THE CHEMISTRY OF ESSENTIAL OILS AND  
ARTIFICIAL PERFUMES.** By ERNEST J. PARRY,  
B.Sc. (Lond.), F.I.C., F.C.S. Second Edition, Revised and  
Enlarged. 552 pp. 20 Illustrations. Demy 8vo. Price 12s. 6d.  
net. (Post free, 13s. 1d. home; 13s. 8d. abroad.)

**(Soap Manufacture.)**

**SOAPS.** A Practical Manual of the Manufacture of  
Domestic, Toilet and other Soaps. By GEORGE H. HURST, F.C.S.  
2nd edition. 390 pp. 66 Illustrations. Demy 8vo. Price 12s. 6d.  
net. (Post free, 13s. home; 13s. 2d. abroad.)

**TEXTILE SOAPS AND OILS.** Handbook on the  
Preparation, Properties and Analysis of the Soaps and Oils used  
in Textile Manufacturing, Dyeing and Printing. By GEORGE  
H. HURST, F.C.S. Second Edition, Revised and partly re-  
written by W. H. SIMMONS, B.Sc. (Lond.). Demy 8vo. 200 pp.  
11 Illustrations. Price 7s. 6d. net. (Post free, 8s. home and  
abroad.)

**THE HANDBOOK OF SOAP MANUFACTURE.**  
By WM. H. SIMMONS, B.Sc. (Lond.), F.C.S., and H. A. APPLETON.  
Demy 8vo. 160 pp. 27 Illustrations. Price 8s. 6d. net. (Post  
free, 9s. home and abroad.)

**MANUAL OF TOILET SOAPMAKING,** including  
Medicated Soaps, Stain-removing Soaps, Metal Polishing Soaps,  
Soap Powders and Detergents. Translated from the German  
of Dr. C. DEITE. Demy 4to. 150 pages. 79 Illustrations.  
Price 12s. 6d. net. (Post free, 13s. home; 13s. 4d. abroad.)

**(Cosmetical Preparations.)**

**COSMETICS: MANUFACTURE, EMPLOYMENT  
AND TESTING OF ALL COSMETIC  
MATERIALS AND COSMETIC SPECIALTIES.**  
Translated from the German of Dr. THEODOR KOLLER. Crown  
8vo. 262 pp. Price 5s. net. (Post free, 5s. 5d. home; 5s. 6d.  
abroad.)

(Glue, Bone Products and Manures.)

**GLUE AND GLUE TESTING.** By SAMUEL RIDEAL, D.Sc. (Lond.). Second Edition, Revised and Enlarged. Demy 8vo. 196 pp. 14 Illustrations. Price 10s. 6d. net. (Post free, 11s. home and abroad.)

**BONE PRODUCTS AND MANURES:** An Account of the most recent Improvements in the Manufacture of Fat, Glue, Animal Charcoal, Size, Gelatine and Manures. By THOMAS LAMBERT, Technical and Consulting Chemist. Second Revised Edition. Demy 8vo. 172 pages. 17 Illustrations. Price 7s. 6d. net. (Post free, 8s. home and abroad.)

(See also *Chemical Manures*, p. 9.)

(Chemicals, Waste Products, etc.)

**REISSUE OF CHEMICAL ESSAYS OF C. W. SCHEELLE.** First Published in English in 1786. Translated from the Academy of Sciences at Stockholm, with Additions. 300 pp. Demy 8vo. Price 5s. net. (Post free, 5s. 6d. home and abroad.)

**THE MANUFACTURE OF ALUM AND THE SULPHATES AND OTHER SALTS OF ALUMINA AND IRON.** Their Uses and Applications as Mordants in Dyeing and Calico Printing, and their other Applications in the Arts, Manufactures, Sanitary Engineering, Agriculture and Horticulture. Translated from the French of LUCIEN GESCHWIND. 195 Illustrations. 400 pp. Royal 8vo. Price 12s. 6d. net. (Post free, 13s. home; 13s. 2d. abroad.)

**AMMONIA AND ITS COMPOUNDS:** Their Manufacture and Uses. By CAMILLE VINCENT, Professor at the Central School of Arts and Manufactures, Paris. Translated from the French by M. J. SALTER. Royal 8vo. 114 pp. Thirty-two Illustrations. Price 5s. net. (Post free, 5s. 5d. home; 5s. 8d. abroad.)

**CHEMICAL WORKS:** Their Design, Erection, and Equipment. By S. S. DYSON and S. S. CLARKSON. Royal 8vo. 220 pp. With 9 Folding Plates and 60 Illustrations. Price 21s. net. (Post free, 21s. 6d. home; 21s. 10d. abroad.)

**MANUAL OF CHEMICAL ANALYSIS,** as applied to the Assay of Fuels, Ores, Metals, Alloys, Salts and other Mineral Products. By E. PROST, D.Sc. Translated by J. CRUICKSHANK SMITH, B.Sc. Royal 8vo. 300 pages. 44 Illustrations. Price 12s. 6d. net. (Post free, 13s. home; 13s. 4d. abroad.)

**TESTING OF CHEMICAL REAGENTS FOR PURITY.** Translated from the German of Dr. C. KRAUCH. Royal 8vo. 350 pages. Price 12s. 6d. net. (Post free, 13s. home; 13s. 4d. abroad.)

---

*For contents of these books, see List I.*



**SHALE OILS AND TARS** and their Products. By Dr. W. SCHEITHAUER. Translated from the German. Demy 8vo. 190 pages. 70 Illustrations and 4 Diagrams. Price 8s. 6d. net. (Post free, 9s. home and abroad.)

**THE BY-PRODUCTS OF COAL-GAS MANUFACTURE.** By K. R. LANGE. Translated from the German. Crown 8vo. 164 pages. 13 Illustrations. Price 5s. net. (Post free, 5s. 4d. home and abroad.)

**INDUSTRIAL ALCOHOL.** A Practical Manual on the Production and Use of Alcohol for Industrial Purposes and for Use as a Heating Agent, as an Illuminant and as a Source of Motive Power. By J. G. McINTOSH. Demy 8vo. 1907. 250 pp. With 75 Illustrations and 25 Tables. Price 7s. 6d. net. (Post free, 8s. home and abroad.)

**THE UTILISATION OF WASTE PRODUCTS.** A Treatise on the Rational Utilisation, Recovery and Treatment of Waste Products of all kinds. By Dr. THEODOR KOLLER. Translated from the Second Revised German Edition. Second English Revised Edition. Demy 8vo. 336 pp. 22 Illustrations. Price 7s. 6d. net. (Post free, 8s. home; 8s. 2d. abroad.)

**ANALYSIS OF RESINS AND BALSAMS.** Translated from the German of Dr. KARL DIETERICH. Demy 8vo. 340 pp. Price 7s. 6d. net. (Post free, 8s. home and abroad.)

**DISTILLATION OF RESINS, RESINATE LAKES AND PIGMENTS, CARBON PIGMENTS AND PIGMENTS FOR TYPEWRITING MACHINES, MANIFOLDERS, ETC.** By VICTOR SCHWEIZER. Demy 8vo. 185 pages. 68 Illustrations. Price 7s. 6d. net. (Post free, 8s. home and abroad.)

**DISINFECTION AND DISINFECTANTS.** By M. CHRISTIAN. Translated from the German. Crown 8vo. 112 pages. 18 Illustrations. Price 5s. net. (Post free, 5s. 4d. home and abroad.)

### (Agricultural Chemistry and Manures.)

**MANUAL OF AGRICULTURAL CHEMISTRY.** By HERBERT INGLE, F.I.C., Late Lecturer on Agricultural Chemistry, the Leeds University; Lecturer in the Victoria University. Third and Revised Edition. 400 pp. 16 Illustrations. Demy 8vo. Price 7s. 6d. net. (Post free, 8s. home; 8s. 2d. abroad.)

**CHEMICAL MANURES.** Translated from the French of J. FRITSCH. Demy 8vo. Illustrated. 340 pp. Price 10s. 6d. net. (Post free, 11s. home; 11s. 2d. abroad.)

(See also *Bone Products and Manures*, p. 8.)

**(Writing Inks and Sealing Waxes.)**

**INK MANUFACTURE:** Including Writing, Copying, Lithographic, Marking, Stamping and Laundry Inks. By SIGMUND LEHNER. Translated from the German of the Fifth Edition. Second Revised and Enlarged English Edition. Crown 8vo. 180 pages. Three Illustrations. Price 5s. net. (Post free, 5s. 4d. home and abroad.)

**SEALING - WAXES, WAFERS AND OTHER ADHESIVES FOR THE HOUSEHOLD, OFFICE, WORKSHOP AND FACTORY.** By H. C. STANDAGE. Crown 8vo. 96 pp. Price 5s. net. (Post free, 5s. 5d. home and abroad.)

**(Lead Ores and Lead Compounds.)**

**LEAD AND ITS COMPOUNDS.** By THOS. LAMBERT, Technical and Consulting Chemist. Demy 8vo. 226 pp. Forty Illustrations. Price 7s. 6d. net. (Post free, 8s. home and abroad.)

**NOTES ON LEAD ORES:** Their Distribution and Properties. By JAS. FAIRIE, F.G.S. Crown 8vo. 64 pages. Price 1s. net. (Post free, 1s. 4d. home and abroad.)

*(White Lead and Zinc White Paints, see p. 5.)*

**(Industrial Hygiene.)**

**THE RISKS AND DANGERS TO HEALTH OF VARIOUS OCCUPATIONS AND THEIR PREVENTION.** By LEONARD A. PARRY, M.D., B.Sc. (Lond.). 196 pp. Demy 8vo. Price 7s. 6d. net. (Post free, 7s. 10d. home and abroad.)

**(Industrial Uses of Air, Steam and Water.)**

**DRYING BY MEANS OF AIR AND STEAM.** Explanations, Formulæ, and Tables for Use in Practice. Translated from the German of E. HAUSBRAND. Second Revised English Edition. Two folding Diagrams, Thirteen Tables, and Two Illustrations. Crown 8vo. 76 pp. Price 5s. net. (Post free, 5s. 4d. home and abroad.)

*(See also "Evaporating, Condensing and Cooling Apparatus," p. 18.)*

**PURE AIR, OZONE AND WATER.** A Practical Treatise of their Utilisation and Value in Oil, Grease, Soap, Paint, Glue and other Industries. By W. B. COWELL. Twelve Illustrations. Crown 8vo. 85 pp. Price 5s. net. (Post free, 5s. 5d. home; 5s. 6d. abroad.)

---

*For contents of these books, see List III.*

**THE INDUSTRIAL USES OF WATER. COMPOSITION—EFFECTS—TROUBLES—REMEDIES—RESIDUARY WATERS—PURIFICATION—ANALYSIS.** By H. DE LA COUX. Royal 8vo. Translated from the French and Revised by ARTHUR MORRIS. 364 pp. 135 Illustrations. Price 10s. 6d. net. (Post free, 11s. home; 11s. 6d. abroad.)

(See *Books on Smoke Prevention, Engineering and Metallurgy*, p. 18.)

### (X Rays.)

**PRACTICAL X RAY WORK.** By FRANK T. ADDYMAN, B.Sc. (Lond.), F.I.C., Member of the Roentgen Society of London; Radiographer to St. George's Hospital; Demonstrator of Physics and Chemistry, and Teacher of Radiography in St. George's Hospital Medical School. Demy 8vo. Twelve Plates from Photographs of X Ray Work. Fifty-two Illustrations. 200 pp. Price 10s. 6d. net. (Post free, 11s. home; 11s. 2d. abroad.)

### (India-Rubber and Gutta Percha.)

**INDIA-RUBBER AND GUTTA PERCHA.** Second English Edition, Revised and Enlarged. Based on the French work of T. SEELIGMANN, G. LAMY TORRILHON and H. FALCONNET by JOHN GEDDES MCINTOSH. Royal 8vo. 100 Illustrations. 400 pages. Price 12s. 6d. net. (Post free, 13s. 1d. home; 13s. 8d. abroad.)

### (Leather Trades.)

**THE LEATHER WORKER'S MANUAL.** Being a Compendium of Practical Recipes and Working Formulæ for Curriers, Bootmakers, Leather Dressers, Blacking Manufacturers, Saddlers, Fancy Leather Workers. By H. C. STANDAGE. Demy 8vo. 165 pp. Price 7s. 6d. net. (Post free, 8s. home and abroad.)

(See also *Manufacture of Shoe Polishes, Leather Dressings, etc.*, p. 6.)

### (Pottery, Bricks, Tiles, Glass, etc.)

**MODERN BRICKMAKING.** By ALFRED B. SEARLE, Royal 8vo. 440 pages. 260 Illustrations. Price 12s. 6d. net. (Post free, 13s. 1d. home; 13s. 7d. abroad.)

**THE MANUAL OF PRACTICAL POTTING.** Compiled by Experts, and Edited by CHAS. F. BINNS. Fourth Edition, Revised and Enlarged. 200 pp. Demy 8vo. Price 17s. 6d. net. (Post free, 18s. home; 18s. 2d. abroad.)

**POTTERY DECORATING.** A Description of all the Processes for Decorating Pottery and Porcelain. By R. HAINBACH. Translated from the German. Crown 8vo. 250 pp. Twenty-two Illustrations. Price 7s. 6d. net. (Post free, 8s. home; 8s. 2d. abroad.)

**A TREATISE ON CERAMIC INDUSTRIES.** A Complete Manual for Pottery, Tile, and Brick Manufacturers. By EMILE BOURRY. A Revised Translation from the French, with some Critical Notes by ALFRED B. SEARLE. Demy 8vo. 308 Illustrations. 460 pp. Price 12s. 6d. net. (Post free, 13s. home; 13s. 6d. abroad.)

**ARCHITECTURAL POTTERY.** Bricks, Tiles, Pipes, Enamelled Terra-cottas, Ordinary and Incrusted Quarries, Stoneware Mosaics, Faïences and Architectural Stoneware. By LÉON LEFÈVRE. Translated from the French by K. H. BIRD, M.A., and W. MOORE BINNS. With Five Plates. 950 Illustrations in the Text, and numerous estimates. 500 pp. Royal 8vo. Price 15s. net. (Post free, 15s. 7d. home; 16s. 4d. abroad.)

**THE ART OF RIVETING GLASS, CHINA AND EARTHENWARE.** By J. HOWORTH. Second Edition. Paper Cover. Price 1s. net. (By post, home or abroad, 1s. 2d.)

**NOTES ON POTTERY CLAYS.** The Distribution, Properties, Uses and Analyses of Ball Clays, China Clays and China Stone. By JAS. FAIRIE, F.G.S. 132 pp. Crown 8vo. Price 3s. 6d. net. (Post free, 4s. home and abroad.)

**HOW TO ANALYSE CLAY.** By H. M. ASHBY. Demy 8vo. 72 pp. 20 Illustrations. Price 3s. 6d. net. (Post free, 3s. 10d. home and abroad.)

A Reissue of

**THE HISTORY OF THE STAFFORDSHIRE POTTERIES; AND THE RISE AND PROGRESS OF THE MANUFACTURE OF POTTERY AND PORCELAIN.** With References to Genuine Specimens, and Notices of Eminent Potters. By SIMON SHAW. (Originally published in 1829.) 265 pp. Demy 8vo. Price 5s. net. (Post free, 5s. 6d. home; 5s. 10d. abroad.)

A Reissue of

**THE CHEMISTRY OF THE SEVERAL NATURAL AND ARTIFICIAL HETEROGENEOUS COMPOUNDS USED IN MANUFACTURING PORCELAIN, GLASS AND POTTERY.** By SIMON SHAW. (Originally published in 1837.) 750 pp. Royal 8vo. Price 10s. net. (Post free, 10s. 7d. home; 11s. 6d. abroad.)

**BRITISH POTTERY MARKS.** By G. WOOLLISCROFT RHEAD. Demy 8vo. 310 pp. With over Twelve-hundred Illustrations of Marks. Price 7s. 6d. net. (Post free, 8s. home; 8s. 4d. abroad.)

---

*For contents of these books, see List III.*

**(Glassware, Glass Staining and Painting.)**

**RECIPES FOR FLINT GLASS MAKING.** By a British Glass Master and Mixer. Sixty Recipes. Being Leaves from the Mixing Book of several experts in the Flint Glass Trade, containing up-to-date recipes and valuable information as to Crystal, Demi-crystal and Coloured Glass in its many varieties. It contains the recipes for cheap metal suited to pressing, blowing, etc., as well as the most costly crystal and ruby. Second Edition. Crown 8vo. Price 10s. 6d. net. (Post free, 10s. 10d. home and abroad.)

**A TREATISE ON THE ART OF GLASS PAINTING.** Prefaced with a Review of Ancient Glass. By ERNEST R. SUPFLING. With One Coloured Plate and Thirty-seven Illustrations. Demy 8vo. 140 pp. Price 7s. 6d. net. (Post free, 8s. home and abroad.)

**(Paper Making and Testing.)**

**THE PAPER MILL CHEMIST.** By HENRY P. STEVENS, M.A., Ph.D., F.I.C. Royal 12mo. 60 Illustrations. 300 pp. Price 7s. 6d. net. (Post free, 7s. 10d. home; 8s. abroad.)

**THE TREATMENT OF PAPER FOR SPECIAL PURPOSES.** By L. E. ANDÉS. Translated from the German. Crown 8vo. 48 Illustrations. 250 pp. Price 6s. net. (Post free, 6s. 5d. home; 6s. 6d. abroad.)

**(Enamelling on Metal.)**

**ENAMELS AND ENAMELLING.** For Enamel Makers, Workers in Gold and Silver, and Manufacturers of Objects of Art. By PAUL RANDAU. Second and Revised Edition. Translated from the German. With 16 Illustrations. Demy 8vo. 200 pp. Price 10s. 6d. net. (Post free, 11s. home; 11s. 2d. abroad.)

**THE ART OF ENAMELLING ON METAL.** By W. NORMAN BROWN. Second Edition, Revised. Crown 8vo. 60 pp. Price 3s. 6d. net. (Post free, 3s. 10d. home and abroad.)

**(Textile Subjects.)**

**THE FINISHING OF TEXTILE FABRICS** (Woollen, Worsted, Union, and other Cloths). By ROBERTS BEAUMONT, M.Sc., M.I.Mech.E. With 150 Illustrations of Fibres, Yarns and Fabrics, also Sectional and other Drawings of Finishing Machinery. Demy 8vo. 260 pp. Price 10s. 6d. net. (Post free, 11s. home; 11s. 2d. abroad.)

**STANDARD CLOTHS:** Structure and Manufacture (General, Military and Naval). By ROBERTS BEAUMONT, M.Sc., M.I.Mech.E. 342 pp. Numerous Illustrations. 16 Plates in Monochrome and Colour. Demy 8vo. Price 12s. 6d. net. (Post free, 13s. home; 13s. 4d. abroad.) *[Just published.*

- FIBRES USED IN TEXTILE AND ALLIED INDUSTRIES.** By C. AINSWORTH MITCHELL, B.A. (Oxon.), F.I.C., and R. M. PRIDEAUX, F.I.C. With 66 Illustrations specially drawn direct from the Fibres. Demy 8vo. 200 pp. Price 7s. 6d. net. (Post free, 8s. home; 8s. 2d. abroad.)
- DRESSINGS AND FINISHINGS FOR TEXTILE FABRICS AND THEIR APPLICATION.** Description of all the Materials used in Dressing Textiles: Their Special Properties, the preparation of Dressings and their employment in Finishing Linen, Cotton, Woollen and Silk Fabrics. Fireproof and Waterproof Dressings, together with the principal machinery employed. Translated from the Third German Edition of FRIEDRICH POLLEYN. Demy 8vo. 280 pp. Sixty Illustrations. Price 7s. 6d. net. (Post free, 8s. home; 8s. 2d. abroad.)
- THE CHEMICAL TECHNOLOGY OF TEXTILE FIBRES:** Their Origin, Structure, Preparation, Washing, Bleaching, Dyeing, Printing and Dressing. By Dr. GEORG VON GEORGIEVICS. Translated from the German by CHARLES SALTER. 320 pp. Forty-seven Illustrations. Royal 8vo. Price 10s. 6d. net. (Post free, 11s. home; 11s. 4d. abroad.)
- POWER-LOOM WEAVING AND YARN NUMBERING,** According to Various Systems, with Conversion Tables. Translated from the German of ANTHON GRUNER. With **Twenty-six Diagrams in Colours.** 150 pp. Crown 8vo. Price 7s. 6d. net. (Post free, 7s. 11d. home; 8s. abroad.)
- TEXTILE RAW MATERIALS AND THEIR CONVERSION INTO YARNS.** (The Study of the Raw Materials and the Technology of the Spinning Process.) By JULIUS ZIPSER. Translated from German by CHARLES SALTER. 302 Illustrations. 500 pp. Demy 8vo. Price 10s. 6d. net. (Post free, 11s. 1d. home; 11s. 8d. abroad.)
- GRAMMAR OF TEXTILE DESIGN.** By H. NISBET, Weaving and Designing Master, Bolton Municipal Technical School. Demy 8vo. 280 pp. 490 Illustrations and Diagrams. Price 6s. net. (Post free, 6s. 5d. home; 6s. 8d. abroad.)
- ART NEEDLEWORK AND DESIGN. POINT LACE.** A Manual of Applied Art for Secondary Schools and Continuation Classes. By M. E. WILKINSON. Oblong quarto. With 22 Plates. Bound in Art Linen. Price 3s. 6d. net. (Post free, 4s. home and abroad.)
- HOME LACE-MAKING.** A Handbook for Teachers and Pupils. By M. E. W. MILROY. Crown 8vo. 64 pp. With 3 Plates and 9 Diagrams. *New Edition in the Press.*
- CHURCH LACE.** By M. E. W. MILROY. *In preparation.*

---

*For contents of these books, see List II.*

**THE CHEMISTRY OF HAT MANUFACTURING.**

Lectures delivered before the Hat Manufacturers' Association. By WATSON SMITH, F.C.S., F.I.C. Revised and Edited by ALBERT SHONK. Crown 8vo. 132 pp. 16 Illustrations. Price 7s. 6d. net. (Post free, 7s. 11d. home; 8s. abroad.)

**THE TECHNICAL TESTING OF YARNS AND TEXTILE FABRICS.**

With Reference to Official Specifications. Translated from the German of Dr. J. HERZFELD. Second Edition. Sixty-nine Illustrations. 200 pp. Demy 8vo. Price 10s. 6d. net. (Post free, 11s. home; 11s. 2d. abroad.)

**DECORATIVE AND FANCY TEXTILE FABRICS.**

By R. T. LORD. For Manufacturers and Designers of Carpets, Damask, Dress and all Textile Fabrics. 200 pp. Demy 8vo. 132 Designs and Illustrations. Price 7s. 6d. net. (Post free, 8s. home; 8s. 2d. abroad.)

**THEORY AND PRACTICE OF DAMASK WEAVING.**

By H. KINZER and K. WALTER. Royal 8vo. Eighteen Folding Plates. Six Illustrations. Translated from the German. 110 pp. Price 8s. 6d. net. (Post free, 9s. home; 9s. 2d. abroad.)

**FAULTS IN THE MANUFACTURE OF WOOLLEN GOODS AND THEIR PREVENTION.**

By NICOLAS REISER. Translated from the Second German Edition. Crown 8vo. Sixty-three Illustrations. 170 pp. Price 5s. net. (Post free, 5s. 5d. home; 5s. 6d. abroad.)

**SPINNING AND WEAVING CALCULATIONS,**

especially relating to Woollens. From the German of N. REISER. Thirty-four Illustrations. Tables. 160 pp. Demy 8vo. 1904. Price 10s. 6d. net. (Post free, 11s. home; 11s. 2d. abroad.)

**WORSTED SPINNERS' PRACTICAL HANDBOOK.**

By H. TURNER. 148 pp. 54 Drawings. Crown 8vo. Price 6s. net. (Post free, 6s. 5d. home; 6s. 6d. abroad.)

**ANALYSIS OF WOVEN FABRICS.**

By A. F. BARKER, M.Sc., and E. MIDGLEY. Demy 8vo. 316 pp. Numerous Tables, Examples and 82 Illustrations. Price 7s. 6d. net. (Post free, 8s. home; 8s. 4d. abroad.)

**WATERPROOFING OF FABRICS.**

By Dr. S. MIERZINSKI. Second Edition, Revised and Enlarged. Crown 8vo. 140 pp. 29 Illus. Price 5s. net. (Post free, 5s. 5d. home; 5s. 6d. abroad.)

**HOW TO MAKE A WOOLLEN MILL PAY.**

By JOHN MACKIE. Crown 8vo. 76 pp. Price 3s. 6d. net. (Post free, 3s. 10d. home and abroad.)

**YARN AND WARP SIZING IN ALL ITS BRANCHES.**

Translated from the German of CARL KRETSCHMAR. Royal 8vo. 123 Illustrations. 150 pp. Price 10s. 6d. net. (Post free, 11s. home; 11s. 4d. abroad.)

(For "Textile Soaps and Oils" see p. 7.)

## (Dyeing, Colour Printing, Matching and Dye-stuffs.)

### **THE COLOUR PRINTING OF CARPET YARNS.**

Manual for Colour Chemists and Textile Printers. By DAVID PATERSON, F.C.S. Seventeen Illustrations. 136 pp. Demy 8vo. Price 7s. 6d. net. (Post free, 8s. home and abroad.)

### **TEXTILE COLOUR MIXING.**

By DAVID PATERSON, F.R.S.E., F.C.S. Formerly published under title of "Science of Colour Mixing". Second Revised Edition. Demy 8vo. 140 pp. 41 Illustrations, with 5 Coloured Plates and 4 Plates showing Dyed Specimens. Price 7s. 6d. net. (Post free, 8s. home 8s. 2d. abroad.)

**DYERS' MATERIALS :** An Introduction to the Examination, Evaluation and Application of the most important Substances used in Dyeing, Printing, Bleaching and Finishing. By PAUL HEERMAN, Ph.D. Translated from the German by A. C. WRIGHT, M.A. (Oxon.), B.Sc. (Lond.). Twenty-four Illustrations. Crown 8vo. 150 pp. Price 5s. net. (Post free, 5s. 5d. home; 5s. 6d. abroad.)

### **COLOUR MATCHING ON TEXTILES.**

A Manual intended for the use of Students of Colour Chemistry, Dyeing and Textile Printing. By DAVID PATERSON, F.C.S. Coloured Frontispiece. Twenty-nine Illustrations and Fourteen Specimens of Dyed Fabrics. Demy 8vo. 132 pp. Price 7s. 6d. net. (Post free, 8s. home and abroad.)

### **COLOUR : A HANDBOOK OF THE THEORY OF**

**COLOUR.** By GEORGE H. HURST. With Eleven Coloured Plates and Seventy-two Illustrations. Second Edition. Demy 8vo. 168 pp. Price 7s. 6d. net. (Post free, 8s. home; 8s. 2d. abroad.)

Reissue of

### **THE ART OF DYEING WOOL, SILK AND**

**COTTON.** Translated from the French of M. HELLOT, M. MACQUER and M. LE PILEUR D'APLIGNY. First Published in English in 1789. Six Plates. Demy 8vo. 446 pp. Price 5s. net. (Post free, 5s. 6d. home; 6s. 4d. abroad.)

### **THE CHEMISTRY OF DYE-STUFFS.**

By Dr. GEORG VON GEORGIEVICS. Translated from the Second German Edition. 412 pp. Demy 8vo. Price 10s. 6d. net. (Post free, 11s. home; 11s. 4d. abroad.)

### **THE DYEING OF COTTON FABRICS : A Practical**

Handbook for the Dyer and Student. By FRANKLIN BEECH, Practical Colourist and Chemist. 272 pp. Forty-four Illustrations of Bleaching and Dyeing Machinery. Demy 8vo.

*[New Revised Edition in the Press.]*

### **THE DYEING OF WOOLLEN FABRICS.**

By FRANKLIN BEECH, Practical Colourist and Chemist. Thirty-three Illustrations. Demy 8vo. 228 pp. Price 7s. 6d. net. (Post free, 8s. home; 8s. 2d. abroad.)

---

*For contents of these books, see List II.*



## (Silk Manufacture.)

**SILK THROWING AND WASTE SILK SPINNING.** By HOLLINS RAYNER. Demy 8vo. 170 pp. 117 illus. Price 5s. net. (Post free, 5s. 5d. home; 5s. 8d. abroad.)

## (Bleaching and Bleaching Agents.)

**A PRACTICAL TREATISE ON THE BLEACHING OF LINEN AND COTTON YARN AND FABRICS.** By L. TAILFER, Chemical and Mechanical Engineer. Translated from the French by JOHN GEDDES MCINTOSH. Demy 8vo. 303 pp. Twenty Illustrations. Price 12s. 6d. net. (Post free, 13s. home; 13s. 4d. abroad.)

**MODERN BLEACHING AGENTS AND DETERGENTS.** By Professor MAX BOTTLER. Translated from the German. Crown 8vo. 16 Illustrations. 160 pages. Price 5s. net. (Post free, 5s. 5d. home; 5s. 6d. abroad.)

## (Cotton Spinning, Cotton Waste and Cotton Combing.)

**COTTON SPINNING (First Year).** By THOMAS THORNLEY, Spinning Master, Bolton Technical School. 160 pp. 84 Illustrations. Crown 8vo. Second Impression. Price 3s. net. (Post free, 3s. 5d. home; 3s. 6d. abroad.)

**COTTON SPINNING (Intermediate, or Second Year).** By T. THORNLEY. Third Edition, Revised and Enlarged. 320 pp. 114 Drawings. Crown 8vo. Price 7s. 6d. net. (Post free, 8s. home; 8s. 2d. abroad.)

[Just Published.]

**COTTON SPINNING (Honours, or Third Year).** By T. THORNLEY. 216 pp. 74 Illustrations. Crown 8vo. Second Edition. Price 5s. net. (Post free, 5s. 5d. home; 5s. 6d. abroad.)

**COTTON COMBING MACHINES.** By THOS. THORNLEY, Spinning Master, Technical School, Bolton. Demy 8vo. 117 Illustrations. 300 pp. Price 7s. 6d. net. (Post free, 8s. home; 8s. 4d. abroad.)

**COTTON WASTE: Its Production, Characteristics, Regulation, Opening, Carding, Spinning and Weaving.** By THOMAS THORNLEY. Demy 8vo. 286 pages. 60 Illustrations. Price 7s. 6d. net. (Post free, 8s. home; 8s. 4d. abroad.)

**THE RING SPINNING FRAME: GUIDE FOR OVERLOOKERS AND STUDENTS.** By N. BOOTH. Crown 8vo. 76 pages. Price 3s. net. (Post free, 3s. 4d. home and abroad.)

## (Flax, Hemp and Jute Spinning.)

**MODERN FLAX, HEMP AND JUTE SPINNING AND TWISTING.** A Practical Handbook for the use of Flax, Hemp and Jute Spinners, Thread, Twine and Rope Makers. By HERBERT R. CARTER, Mill Manager, Textile Expert and Engineer, Examiner in Flax Spinning to the City and Guilds of London Institute. Demy 8vo. 1907. With 92 Illustrations. 200 pp. Price 7s. 6d. net. (Post free, 7s. 11d. home; 8s. 2d. abroad.)

**(Collieries and Mines.)**

**RECOVERY WORK AFTER PIT FIRES.** By ROBERT LAMPRECHT, Mining Engineer and Manager. Translated from the German. Illustrated by Six large Plates, containing Seventy-six Illustrations. 175 pp. Demy 8vo. Price 10s. 6d. net. (Post free, 11s. home; 11s. 2d. abroad.)

**VENTILATION IN MINES.** By ROBERT WABNER, Mining Engineer. Translated from the German. Royal 8vo. Thirty Plates and Twenty-two Illustrations. 240 pp. Price 10s. 6d. net. (Post free, 11s. home; 11s. 6d. abroad.)

**THE ELECTRICAL EQUIPMENT OF COLLIERIES.** By W. GALLOWAY DUNCAN and DAVID PENMAN. Demy 8vo. 310 pp. 155 Illustrations and Diagrams. Price 10s. 6d. net. (Post free, 11s. home; 11s. 4d. abroad.)

**(Dental Metallurgy.)**

**DENTAL METALLURGY: MANUAL FOR STUDENTS AND DENTISTS.** By A. B. GRIFFITHS, Ph.D. Demy 8vo. Thirty-six Illustrations. 200 pp. Price 7s. 6d. net. (Post free, 8s. home; 8s. 2d. abroad.)

**(Engineering, Smoke Prevention and Metallurgy.)**

**THE PREVENTION OF SMOKE.** Combined with the Economical Combustion of Fuel. By W. C. POPPLEWELL, M.Sc., A.M. Inst., C.E., Consulting Engineer. Forty-six Illustrations. 190 pp. Demy 8vo. Price 7s. 6d. net. (Post free, 8s. home; 8s. 2d. abroad.)

**GAS AND COAL DUST FIRING.** A Critical Review of the Various Appliances Patented in Germany for this purpose since 1885. By ALBERT PÖTSCH. 130 pp. Demy 8vo. Translated from the German. With 103 Illustrations. Price 5s. net. (Post free, 5s. 5d. home; 5s. 6d. abroad.)

**THE HARDENING AND TEMPERING OF STEEL IN THEORY AND PRACTICE.** By FRIDOLIN REISER. Translated from the German of the Third Edition. Crown 8vo. 120 pp. Price 5s. net. (Post free, 5s. 4d. home and abroad.)

**SIDEROLOGY: THE SCIENCE OF IRON** (The Constitution of Iron Alloys and Slags). Translated from German of HANNS FREIHERR v. JÜPTNER. 350 pp. Demy 8vo. Eleven Plates and Ten Illustrations. Price 10s. 6d. net. (Post free, 11s. home; 11s. 4d. abroad.)

**EVAPORATING, CONDENSING AND COOLING APPARATUS.** Explanations, Formulæ and Tables for Use in Practice. By E. HAUSBRAND, Engineer. Translated by A. C. WRIGHT, M.A. (Oxon.), B.Sc. (Lond.). With Twenty-one Illustrations and Seventy-six Tables. 400 pp. Demy 8vo. Revised English Edition. Price 12s. 6d. net. (Post free, 13s. home; 13s. 6d. abroad.)

---

*For contents of these books, see Lists II and III.*

(The "Broadway" Series of Engineering Handbooks.)

Uniform in Size: Narrow Crown 8vo. (Pocket Size.)

- VOLUME I.—ELEMENTARY PRINCIPLES OF REINFORCED CONCRETE CONSTRUCTION.** By EWART S. ANDREWS, B.Sc. Eng. (Lond.). 200 pages. With 57 Illustrations. Numerous Tables and Worked Examples. Price 3s. net. (Post free, 3s. 5d. home; 3s. 6d. abroad.)
- VOLUME II.—GAS AND OIL ENGINES.** By A. KIRSCHKE. Translated and Revised from the German, and adapted to British practice. 160 pages. 55 Illustrations. Price 3s. net. (Post free, 3s. 5d. home; 3s. 6d. abroad.)
- VOLUME III.—IRON AND STEEL STRUCTURAL WORK.** By K. SCHINDLER. Translated and Revised from the German, and adapted to British practice. 140 pages. 115 Illustrations. Price 3s. 6d. net. (Post free, 3s. 11d. home; 4s. abroad.)
- VOLUME IV.—TOOTHED GEARING.** By G. T. WHITE, B.Sc. (Lond.). 220 pages. 136 Illustrations. Price 3s. 6d. net. (Post free, 3s. 11d. home; 4s. abroad.)
- VOLUME V.—STEAM TURBINES: Their Theory and Construction.** By H. WILDA. Translated from the German; Revised and adapted to British practice. 200 pages. 104 Illustrations. Price 3s. 6d. net. (Post free, 3s. 11d. home; 4s. abroad.)
- VOLUME VI.—CRANES AND HOISTS.** Their Construction and Calculation. By H. WILDA. Translated from the German; revised and adapted to British practice. 168 pages. 399 Illustrations. Price 3s. 6d. net. (Post free, 3s. 11d. home; 4s. abroad.)
- VOLUME VII.—FOUNDRY MACHINERY.** By E. TREIBER. Translated from the German; revised and adapted to British practice. 148 pages. 51 Illustrations. Price 3s. 6d. net. (Post free, 3s. 11d. home; 4s. abroad.)
- VOLUME VIII.—MOTOR CAR MECHANISM.** By W. E. DOMMETT, Wh.Ex., A.M.I.A.E. 200 pages. 102 Illustrations. Price 3s. 6d. net. (Post free, 3s. 11d. home; 4s. abroad.)
- VOLUME IX.—ELEMENTARY PRINCIPLES OF ILLUMINATION AND ARTIFICIAL LIGHTING.** By A. BLOK, B.Sc. 240 pages. 124 Illustrations and Diagrams and 1 Folding Plate. Price 3s. 6d. net. (Post free, 3s. 11d. home; 4s. abroad.)
- VOLUME X.—HYDRAULICS.** By E. H. SPRAGUE, A.M.I.C.E. 190 pages. With Worked Examples and 89 Illustrations. Price 3s. 6d. net. (Post free, 3s. 11d. home; 4s. abroad.)
- VOLUME XI.—ELEMENTARY PRINCIPLES OF SURVEYING.** By M. T. M. ORMSBY, M.I.C.E.I. 244 pages. With Worked Examples and 135 Illustrations and Diagrams, including 4 Folding Plates. Price 4s. net. (Post free, 4s. 5d. home; 4s. 6d. abroad.)
- VOLUME XII.—THE SCIENCE OF WORKS MANAGEMENT.** By JOHN BATEY. 232 pages. Price 4s. net. (Post free, 4s. 5d. home; 4s. 6d. abroad.)

- VOLUME XIII.—THE CALCULUS FOR ENGINEERS.**  
By EWART S. ANDREWS, B.Sc.Eng. (Lond.), and H. BRYON HEYWOOD, D.Sc. (Paris), B.Sc. (Lond.). 284 pages. 102 Illustrations. With Tables and Worked Examples. Price 4s. net. (Post free, 4s. 5d. home; 4s. 6d. abroad.)
- VOLUME XIV.—LATHES: Their Construction and Operation.** By G. W. BURLEY, Wh.Ex., A.M.I.M.E. 244 pages. 200 Illustrations. Price 3s. 6d. net. (Post free, 3s. 11d. home; 4s. abroad.)
- VOLUME XV.—STEAM BOILERS AND COMBUSTION.** By JOHN BATEY. 220 pages. 18 Diagrams. Price 4s. net. (Post free, 4s. 5d. home; 4s. 6d. abroad.)
- VOLUME XVI.—REINFORCED CONCRETE IN PRACTICE.** By A. ALBAN H. SCOTT, M.S.A., M.C.I. 190 pp. 130 Illustrations and Diagrams and 2 Folding Plates. Price 4s. net. (Post free, 4s. 5d. home; 4s. 6d. abroad.)
- VOLUME XVII.—STABILITY OF MASONRY.** By E. H. SPRAGUE, A.M.I.C.E. 180 pp. 92 Illustrations. 3 Folding Plates and Worked Examples. Price 4s. net. (Post free, 4s. 5d. home; 4s. 6d. abroad.)
- VOLUME XVIII.—TESTING OF MACHINE TOOLS.** By G. W. BURLEY, Wh.Ex., A.M.I.M.E. 240 pp. 110 Illustrations. Price 4s. net. (Post free, 4s. 5d. home; 4s. 6d. abroad.)
- VOLUME XIX.—BRIDGE FOUNDATIONS.** By W. BURNSIDE, M.I.C.E. 148 pp. 31 Diagrams. Price 4s. net. (Post free, 4s. 4d. home and abroad.)
- VOLUME XX.—THE STABILITY OF ARCHES.** By E. H. SPRAGUE, A.M.I.C.E. 150 pp. 58 Diagrams. 5 Folding Plates. Price 4s. net. (Post free, 4s. 5d. home; 4s. 6d. abroad.)
- VOLUME XXI.—ELEMENTARY MATHEMATICS FOR ENGINEERS.** By E. H. SPRAGUE, A.M.Inst.C.E. 236 pp. 101 Diagrams. Price 4s. net. (Post free, 4s. 5d. home; 4s. 6d. abroad.)

## [IN PREPARATION.]

- CALCULATIONS FOR STEEL FRAME STRUCTURES.** By W. C. COCKING, M.C.I.
- DRIVING OF MACHINE TOOLS.** By T. R. SHAW.
- DESIGN OF MACHINE ELEMENTS** (in 2 Volumes). By W. G. DUNKLEY.
- ELEMENTS OF GRAPHIC STATICS.** By E. H. SPRAGUE, A.M.I.C.E.
- STRENGTH OF STRUCTURAL ELEMENTS.** By E. H. SPRAGUE, A.M.I.C.E.
- GEAR CUTTING.** By G. W. BURLEY, Wh.Ex., A.M.I.M.E.
- MOVING LOADS BY INFLUENCE LINES AND OTHER METHODS.** By E. H. SPRAGUE, A.M.I.C.E.
- DRAWING OFFICE PRACTICE.** By W. CLEGG.
- ESTIMATING STEELWORK FOR BUILDINGS.** By B. P. F. GLEED and S. BYLANDER, M.C.I.
- THE THEORY OF THE CENTRIFUGAL AND TURBO PUMP.** By J. WELLS CAMERON.
- STRENGTH OF SHIPS.** By JAMES BERTRAM THOMAS
- MACHINE SHOP PRACTICE.** By G. W. BURLEY, Wh.Ex., A.M.I.M.E.
- IRON AND STEEL.** By J. S. GLEN PRIMROSE
- ELECTRIC TRACTION.** By H. M. SAYERS.
- PRECISION GRINDING MACHINES.** By T. R. SHAW.

---

*For contents of these books, see List III.*

**(Sanitary Plumbing, Metal Work, etc.)**

**EXTERNAL PLUMBING WORK.** A Treatise on Lead Work for Roofs. By JOHN W. HART, R.P.C. 180 Illustrations. 272 pp. Demy 8vo. Second Edition Revised. Price 7s. 6d. net. (Post free, 8s. home; 8s. 2d. abroad.)

**HINTS TO PLUMBERS ON JOINT WIPING, PIPE BENDING AND LEAD BURNING.** Third Edition, Revised and Corrected. By JOHN W. HART, R.P.C. 184 Illustrations. 313 pp. Demy 8vo. Price 7s. 6d. net. (Post free, 8s. home; 8s. 4d. abroad.)

**SANITARY PLUMBING AND DRAINAGE.** By JOHN W. HART. Demy 8vo. With 208 Illustrations. 250 pp. 1904. Price 7s. 6d. net. (Post free, 8s. home; 8s. 2d. abroad.)

**THE PRINCIPLES OF HOT WATER SUPPLY.** By JOHN W. HART, R.P.C. With 129 Illustrations. 177 pp. Demy 8vo. Price 7s. 6d. net. (Post free, 8s. home; 8s. 2d. abroad.)

**THE PRINCIPLES AND PRACTICE OF DIPPING, BURNISHING, LACQUERING AND BRONZING BRASS WARE.** By W. NORMAN BROWN. Revised and Enlarged Edition. Crown 8vo. 48 pp. Price 3s. net. (Post free, 3s. 4d. home and abroad.)

**A HANDBOOK ON JAPANING.** For Ironware, Tinware, and Wood, etc. By WILLIAM NORMAN BROWN. Second Edition. Crown 8vo. 70 pages. 13 Illustrations. Price 3s. 6d. net. (Post free, 3s. 10d. home and abroad.)

**SHEET METAL WORKING.** Cutting, Punching, Bending, Folding, Pressing, Drawing and Embossing Metals, with Machinery for same. By F. GEORGI and A. SCHUBERT. Translated from the German. Demy 8vo. 160 pages. 125 Drawings and Illustrations. 2 Folding Plates. Price 7s. 6d. net. (Post free, 8s. home and abroad.)

**(Electric Wiring, etc.)**

**THE DEVELOPMENT OF THE INCANDESCENT ELECTRIC LAMP.** By G. BASIL BARHAM, A.M.I.E.E. Demy 8vo. 200 pages. 2 Plates, 25 Illustrations and 10 Tables. Price 5s. net. (Post free, 5s. 5d. home; 5s. 8d. abroad.)

**WIRING CALCULATIONS FOR ELECTRIC LIGHT AND POWER INSTALLATIONS.** A Practical Handbook containing Wiring Tables, Rules, and Formulæ for the Use of Architects, Engineers, Mining Engineers, and Electricians, Wiring Contractors and Wiremen, etc. By G. W. LUMMIS PATERSON. Crown 8vo. 96 pages. 35 Tables. Price 5s. net. (Post free, 5s. 5d. home; 5s. 6d. abroad.)

**ELECTRIC WIRING AND FITTING.** By SYDNEY F. WALKER, R.N., M.I.E.E., M.I.Min.E., A.M.Inst.C.E., etc., etc. Crown 8vo. 150 pp. With Illustrations and Tables. Price 5s. net. (Post free, 5s. 5d. home; 5s. 6d. abroad.)

**(Brewing and Botanical.)****HOPS IN THEIR BOTANICAL, AGRICULTURAL AND TECHNICAL ASPECT, AND AS AN ARTICLE OF COMMERCE.**

By EMMANUEL GROSS. Translated from the German. 78 Illus. 340 pp. Demy 8vo. Price 10s. 6d. net. (Post free, 11s. home; 11s. 4d. abroad.)

**INSECTICIDES, FUNGICIDES AND WEED-KILLERS.**

By E. BOURCART, D.Sc. Translated from the French. Revised and Adapted to British Standards and Practice. Demy 8vo. 450 pages, 83 Tables, and 12 Illustrations. Price 12s. 6d. net. (Post free, 13s. home; 13s. 4d. abroad.)

(For *Agricultural Chemistry*, see p. 9.)

**(Wood Products, Timber and Wood Waste.)****WOOD PRODUCTS: DISTILLATES AND EXTRACTS.**

By P. DUMESNY, Chemical Engineer, Expert before the Lyons Commercial Tribunal, Member of the International Association of Leather Chemists; and J. NOYER. Translated from the French by DONALD GRANT. Royal 8vo. 320 pp. 103 Illustrations and Numerous Tables. Price 10s. 6d. net. (Post free, 11s. 1d. home; 11s. 8d. abroad.)

**TIMBER: A Comprehensive Study of Wood in all its**

Aspects (Commercial and Botanical), showing the different Applications and Uses of Timber in Various Trades, etc. Translated from the French of PAUL CHARPENTIER. Royal 8vo. 437 pp. 178 Illustrations. Price 12s. 6d. net. (Post free, 13s. home; 13s. 6d. abroad.)

**THE UTILISATION OF WOOD WASTE.**

Translated from the German of E. HUBBARD. Second Revised English Edition. Crown 8vo. 208 pp. 50 Illus. Price 5s. net. (Post free, 5s. 5d. home; 5s. 6d. abroad.)

(See also *Utilisation of Waste Products*, p. 9.)

**(Building and Architecture.)****ORNAMENTAL CEMENT WORK.**

By OLIVER WHEATLEY. Demy 8vo. 83 Illustrations. 128 pp. Price 5s. net. (Post free, 5s. 5d. home; 5s. 6d. abroad.)

**THE PREVENTION OF DAMPNES IN BUILD-**

**INGS;** with Remarks on the Causes, Nature and Effects of Saline, Efflorescences and Dry-rot, for Architects, Builders, Overseers, Plasterers, Painters and House Owners. By ADOLF WILHELM KEIM. Translated from the German of the Second Revised Edition. Eight Coloured Plates and Thirteen Illustrations. Crown 8vo. 115 pp. Price 5s. net. (Post free, 5s. 4d. home and abroad.)

**HANDBOOK OF TECHNICAL TERMS USED IN ARCHITECTURE AND BUILDING, AND THEIR ALLIED TRADES AND SUBJECTS.**

By AUGUSTINE C. PASSMORE. Demy 8vo. 380 pp. Price 7s. 6d. net. (Post free, 8s. home; 8s. 4d. abroad.)

*For contents of these books, see List III.*

**(Foods, Drugs and Sweetmeats.)****FOOD AND DRUGS.** By E. J. PARRY, B.Sc., F.I.C., F.C.S.

Volume I. The Analysis of Food and Drugs (Chemical and Microscopical). Royal 8vo. 724 pp. Price 21s. net. (Post free, 21s. 7d. home; 22s. 6d. British Colonies; 23s. 3d. other Foreign Countries.)

Volume II. The Sale of Food and Drugs Acts, 1875-1907. Royal 8vo. 184 pp. Price 7s. 6d. net. (Post free, 8s. home; 8s. 4d. abroad.)

**THE MANUFACTURE OF PRESERVED FOODS AND SWEETMEATS.** By A. HAUSNER. With

Twenty-eight Illustrations. Translated from the German of the third enlarged Edition. Second English Edition. Crown 8vo. 225 pp. Price 7s. 6d. net. (Post free, 7s. 11d. home; 8s. abroad.)

**RECIPES FOR THE PRESERVING OF FRUIT, VEGETABLES AND MEAT.** By E. WAGNER.

Translated from the German. Crown 8vo. 125 pp. With 14 Illustrations. Price 5s. net. (Post free, 5s. 5d. home; 5s. 6d. abroad.)

**(Dyeing Fancy Goods.)****THE ART OF DYEING AND STAINING MARBLE, ARTIFICIAL STONE, BONE, HORN, IVORY AND WOOD, AND OF IMITATING ALL SORTS OF WOOD.** A Practical Handbook for the Use of

Joiners, Turners, Manufacturers of Fancy Goods, Stick and Umbrella Makers, Comb Makers, etc. Translated from the German of D. H. SOXHLET, Technical Chemist. Crown 8vo. 168 pp. Price 5s. net. (Post free, 5s. 5d. home; 5s. 6d. abroad.)

**(Celluloid.)**

**CELLULOID:** Its Raw Material, Manufacture, Properties and Uses. A Handbook for Manufacturers of Celluloid and Celluloid Articles, and all Industries using Celluloid; also for Dentists and Teeth Specialists. By Dr. Fr. BÖCKMANN, Technical Chemist. Translated from the Third Revised German Edition. Crown 8vo. 120 pp. With 49 Illustrations. Price 5s. net. (Post free, 5s. 5d. home; 5s. 6d. abroad.)

**(Lithography, Printing and Engraving.)**

**ART OF LITHOGRAPHY.** By H. J. RHODES. Demy 8vo. 344 pages. 120 Illustrations. 2 Folding Plates. Copious combined Index and Glossary. Price 10s. 6d. net. (Post free, 11s. home; 11s. 4d. abroad.)

**PRINTERS' AND STATIONERS' READY RECKONER AND COMPENDIUM.**

Compiled by VICTOR GRAHAM. Crown 8vo. 112 pp. 1904. Price 3s. 6d. net. (Post free, 3s. 11d. home; 4s. abroad.)

**ENGRAVING FOR ILLUSTRATION. HISTORICAL AND PRACTICAL NOTES.**

By J. KIRKBRIDE. 72 pp. Two Plates and 6 Illustrations. Crown 8vo. Price 2s. 6d. net. (Post free, 2s. 10d. home and abroad.)

(For Printing Inks, see p. 4.)

**(Bookbinding.)****PRACTICAL BOOKBINDING.**

By PAUL ADAM. Translated from the German. Crown 8vo. 180 pp. 127 Illustrations. Price 5s. net. (Post free, 5s. 5d. home; 5s. 6d. abroad.)

**(Sugar Refining.)****THE TECHNOLOGY OF SUGAR:** Practical Treatise on the Modern Methods of Manufacture of Sugar from the Sugar Cane and Sugar Beet. By JOHN GEDDES MCINTOSH. Third Edition, Revised and Enlarged. Demy 8vo. 540 pages. 244 Illustrations. Price 12s. 6d. net. (Post free, 13s. home; 13s. 6d. abroad.)

[Just published.  
(See "Evaporating, Condensing, etc., Apparatus," p. 18.)

**(Emery.)****EMERY AND THE EMERY INDUSTRY.**

Translated from the German of A. HAENIG. Crown 8vo. 45 Illus. 104 pp. Price 5s. net. (Post free, 5s. 5d. home; 5s. 6d. abroad.)

**(Bibliography.)****CLASSIFIED GUIDE TO TECHNICAL AND COMMERCIAL BOOKS.**

Compiled by EDGAR GREENWOOD. Demy 8vo. 224 pp. 1904. Being a Subject-list of the Principal British and American Books in Print; giving Title, Author, Size, Date, Publisher and Price. Price 5s. net. (Post free, 5s. 5d. home; 5s. 6d. abroad.)

**HANDBOOK TO THE TECHNICAL AND ART SCHOOLS AND COLLEGES OF THE UNITED KINGDOM.**

Containing particulars of nearly 1,000 Technical, Commercial and Art Schools throughout the United Kingdom. With full particulars of the courses of instruction, names of principals, secretaries, etc. Demy 8vo. 150 pp. Price 3s. 6d. net. (Post free, 4s. home and abroad.)

SCOTT, GREENWOOD & SON,  
TECHNICAL BOOK AND TRADE JOURNAL PUBLISHERS,  
8 BROADWAY, LUDGATE, LONDON, E.C.

Telegraphic Address, "Printeries, Cent., London".

November, 1916.



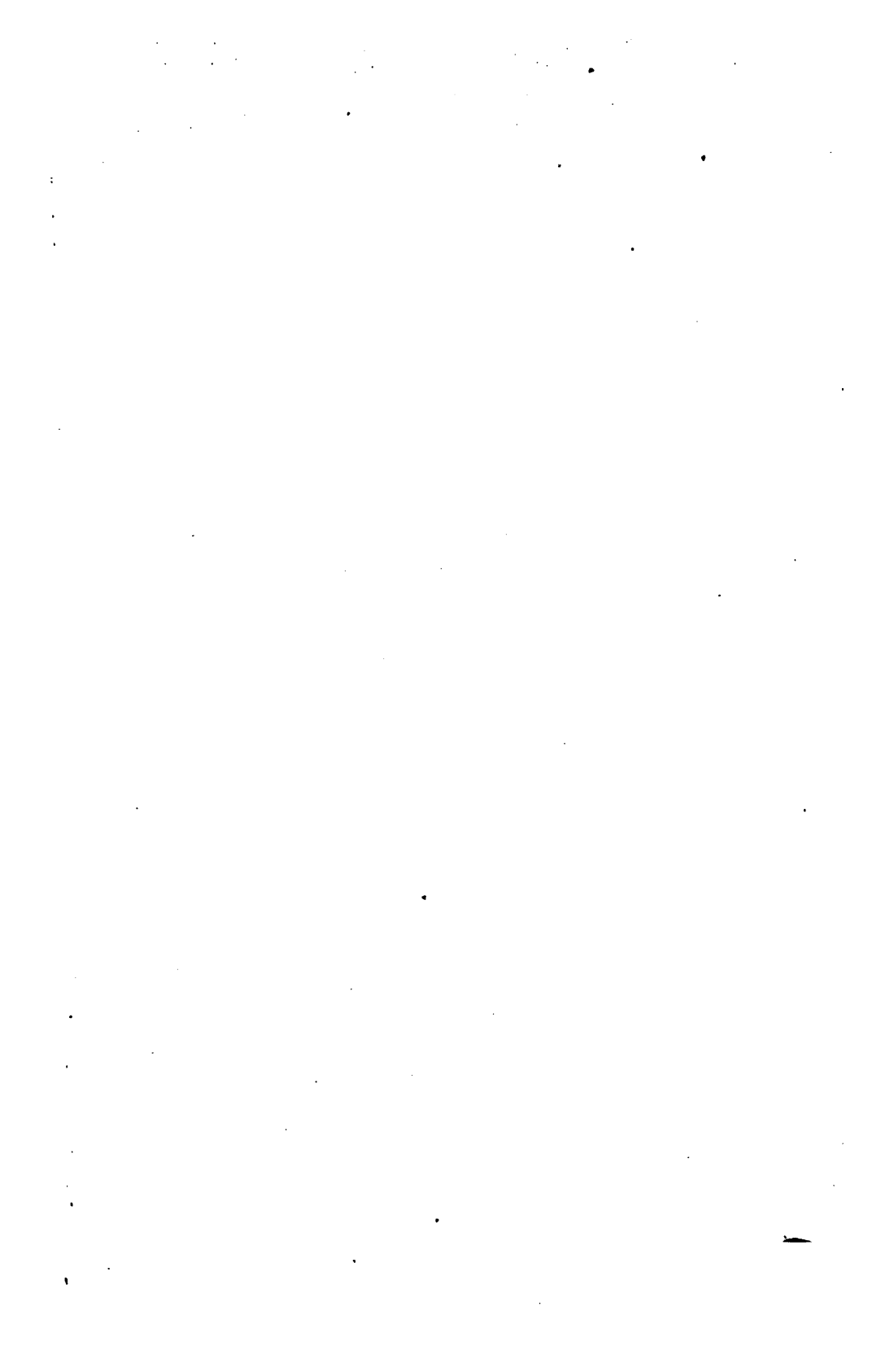

This book should be returned to  
the Library on or before the last date  
stamped below.

A fine is incurred by retaining it  
beyond the specified time.

Please return promptly.

DUE APR 17 '76 FA